

# ADRP 1-02

## TERMS AND MILITARY SYMBOLS

**SEPTEMBER 2013**

**DISTRIBUTION RESTRICTION:**

Approved for public release; distribution is unlimited.

**HEADQUARTERS, DEPARTMENT OF THE ARMY**

This publication is available at Army Knowledge Online  
(<https://armypubs.us.army.mil/doctrine/index.html>).

To receive publishing updates, please subscribe at  
[http://www.apd.army.mil/AdminPubs/new\\_subscribe.asp](http://www.apd.army.mil/AdminPubs/new_subscribe.asp).

# Terms and Military Symbols

## Contents

	Page
<b>PREFACE</b> .....	<b>iv</b>
<b>INTRODUCTION</b> .....	<b>v</b>
<b>Chapter 1 MILITARY TERMS</b> .....	<b>1-1</b>
<b>Chapter 2 ACRONYMS AND ABBREVIATIONS</b> .....	<b>2-1</b>
<b>Section I — Acronyms and Abbreviations</b> .....	<b>2-1</b>
<b>Section II — Geographical Entity Codes</b> .....	<b>2-11</b>
<b>Chapter 3 MILITARY SYMBOLOGY BASICS</b> .....	<b>3-1</b>
Framed Symbols.....	3-1
Location of Amplifiers for Framed Symbols.....	3-4
The Bounding Octagon and the Location of Icons and Modifiers for Framed Symbols.....	3-6
The Building Process for Framed Symbols.....	3-6
Unframed Symbols.....	3-7
<b>Chapter 4 UNITS, INDIVIDUALS, AND ORGANIZATIONS</b> .....	<b>4-1</b>
Main Icons for Units.....	4-1
Main Icons for Individuals and Organizations (Civilian).....	4-9
<b>Chapter 5 EQUIPMENT</b> .....	<b>5-1</b>
Main Icons for Equipment.....	5-1
Sector 1 Modifiers for Equipment.....	5-4
Mobility Indicator Amplifier (Field 13).....	5-4
<b>Chapter 6 INSTALLATIONS</b> .....	<b>6-1</b>
Main Icons for Installations.....	6-1
Sector 1 Modifiers for Installations.....	6-2
Sector 2 Modifiers for Installations.....	6-2
<b>Chapter 7 ACTIVITIES</b> .....	<b>7-1</b>
Main Icons for Activities.....	7-1
Sector 1 Modifiers for Activities.....	7-2

---

Distribution Restriction: Approved for public release; distribution is unlimited.

\*This publication supersedes ADRP 1-02, 31 August 2012, including changes 1 and 2.

<b>Chapter 8</b>	<b>CONTROL MEASURE SYMBOLS .....</b>	<b>8-1</b>
	Basics of Control Measure Symbols .....	8-1
	Point Symbols .....	8-1
	Line Symbols.....	8-2
	Boundary Line Symbols .....	8-3
	Area Symbols.....	8-3
	Abbreviations and Acronyms for Use With Control Measure Symbols.....	8-13
<b>Chapter 9</b>	<b>TACTICAL MISSION TASKS.....</b>	<b>9-1</b>
	Tactical Mission Tasks Defined .....	9-1
	Symbols for Tactical Mission Tasks.....	9-1
<b>Chapter 10</b>	<b>COURSE OF ACTION SKETCH .....</b>	<b>10-1</b>
	Purpose of Course Of Action Sketch .....	10-1
	Makeup of Course of Action Sketch.....	10-1
	<b>REFERENCES.....</b>	<b>References-1</b>

## Figures

Figure 3-1. Amplifier locations .....	3-4
Figure 3-2. Example of full-frame icon .....	3-6
Figure 4-1. Offset locator indicators.....	4-7
Figure 4-2. Headquarters offset locator indicators.....	4-8
Figure 5-1. Examples of mobility indicator amplifiers for framed and unframed equipment symbols.....	5-4
Figure 8-1. Standard point and supply point templates .....	8-2
Figure 8-2. Standard line template.....	8-2
Figure 8-3. Horizontal and vertical boundary templates .....	8-3
Figure 8-4. Standard area template .....	8-4
Figure 9-1. Example of tactical mission task symbol connected to task organization composition symbol .....	9-6
Figure 10-1. Comparison of sample unit and task organization composition symbols.....	10-2
Figure 10-2. Task organization composition symbol example.....	10-2
Figure 10-3. Brigade combat team example.....	10-4

## Tables

Table 3-1. Frame shapes for standard identities .....	3-2
Table 3-2. Examples of status .....	3-3
Table 3-3. Description of amplifier fields.....	3-5
Table 3-4. Examples of horizontal and vertical bounding octagons .....	3-6
Table 3-5. Building process for framed symbols.....	3-7
Table 3-6. Description of control measure symbol amplifier fields .....	3-8
Table 3-7. Building process for control measure symbols .....	3-9
Table 4-1. Main icons for units.....	4-1

Table 4-2. Full-frame icons for units .....	4-2
Table 4-3. Sector 1 modifiers for units .....	4-3
Table 4-4. Sector 2 modifiers for units .....	4-4
Table 4-5. Echelon amplifiers .....	4-5
Table 4-6. Task force amplifier .....	4-5
Table 4-7. Reinforced, reduced, or both amplifiers .....	4-6
Table 4-8. Command post and command group amplifiers .....	4-6
Table 4-9. Combat effectiveness amplifiers .....	4-7
Table 4-10. Examples of unit symbols .....	4-8
Table 4-11. Main icons for civilian individuals and organizations.....	4-9
Table 4-12. Sector 1 modifiers for civilian individuals and organizations.....	4-10
Table 4-13. Sector 2 modifiers for civilian individuals and organizations.....	4-10
Table 4-14. Examples of symbols for civilian individuals and organizations.....	4-10
Table 5-1. Main icons for equipment .....	5-1
Table 5-2. Sector 1 modifiers for equipment .....	5-4
Table 5-3. Mobility indicator amplifiers for equipment.....	5-4
Table 6-1. Main icons for installations .....	6-1
Table 6-2. Sector 1 modifiers for installations .....	6-2
Table 6-3. Sector 2 modifiers for installations .....	6-2
Table 7-1. Main icons for activities .....	7-1
Table 7-2. Sector 1 modifiers for activities .....	7-2
Table 8-1. Mission command .....	8-4
Table 8-2. Movement and maneuver .....	8-5
Table 8-3. Fires .....	8-8
Table 8-4. Protection .....	8-9
Table 8-5. Sustainment .....	8-10
Table 8-6. Intelligence .....	8-11
Table 8-7. Airspace control.....	8-12
Table 8-8. Abbreviations and acronyms for use with boundaries .....	8-14
Table 8-9. Abbreviation and acronyms used in control measure symbols for unit functions.....	8-15
Table 9-1. Tactical mission task symbols.....	9-1
Table 10-1. Task organization icons .....	10-3
Table 10-2. Combat effectiveness icons .....	10-4

## Preface

Army Doctrine Reference Publication (ADRP) 1-02 constitutes approved Army doctrinal terminology and symbology for general use. It builds on the foundational doctrine established in Army Doctrine Publication (ADP) 1-02.

The principal audience for ADRP 1-02 is all members of the profession of Arms. Commanders and staffs of Army headquarters serving as joint task force or multinational headquarters should also refer to applicable joint or multinational doctrine concerning the range of military operations and joint or multinational forces. Trainers and educators throughout the Army will also use this manual.

Commanders, staffs, and subordinates ensure their decisions and actions comply with applicable U.S., international, and, in some cases, host-nation laws and regulations. Commanders at all levels ensure their Soldiers operate in accordance with the law of war and the rules of engagement. (See Field Manual [FM] 27-10.)

This publication implements the following international agreements:

- AAP-15(2013), *NATO Glossary of Abbreviations Used in NATO Documents and Publications (English and French)*.
- STANAG 1241 (ED. 5), *NATO Standard Identity Description Structure for Tactical Use*.
- STANAG 2019 (ED. 6)/APP-6(C), *NATO Joint Military Symbology*.
- STANAG 3680 (ED. 5)/AAP-06(2012)(2), *NATO Glossary of Terms and Definitions (English and French)*.

ADRP 1-02 uses joint terms where applicable.

Unless this publication states otherwise, masculine nouns and pronouns do not refer exclusively to men.

ADRP 1-02 applies to the Active Army, Army National Guard/Army National Guard of the United States, and United States Army Reserve unless otherwise stated.

The proponent of ADRP 1-02 is the United States Army Combined Arms Center. The preparing agency is the Combined Arms Doctrine Directorate, United States Army Combined Arms Center. Send written comments and recommendations on DA Form 2028 (Recommended Changes to Publications and Blank Forms) to Commander, U.S. Army Combined Arms Center and Fort Leavenworth, ATTN: ATZL-MCK-D (ADRP 1-02), 300 McPherson Avenue, Fort Leavenworth, KS 66027-2337; by e-mail to [usarmy.leavenworth.mccoe.mbx.cadd-org-mailbox@mail.mil](mailto:usarmy.leavenworth.mccoe.mbx.cadd-org-mailbox@mail.mil); or submit an electronic DA Form 2028.

# Introduction

This revision of Army Doctrine Reference Publication (ADRP) 1-02 compiles definitions of all Army terms approved for use in Army doctrinal publications (Army doctrine publications [ADPs], ADRPs, field manuals [FMs], and Army techniques publications [ATPs]) as of June 2013. ADRP 1-02 also lists shortened forms (whether considered acronyms or abbreviations) approved for use in Army doctrinal publications. In addition, unlike the 2012 edition of ADRP 1-02, this revision incorporates joint terms appearing in the glossaries of Army doctrinal publications, as of June 2013. This publication's name has been updated to reflect the inclusion of these joint terms. Moreover, the Army's terminology and symbology database, which was under development in 2012, now augments this publication.

ADRP 1-02 also provides a single standard for developing and depicting hand drawn and computer-generated military symbols for situation maps, overlays, and annotated aerial photographs for all types of military operations. It is the Army proponent publication for all military symbols and complies with Department of Defense (DOD) Military Standard (MIL-STD) 2525C. The symbology chapters of this ADRP focus primarily on military symbols applicable to Army land operations. When communicating instructions to subordinate units, commanders and staffs from company through corps level should use this publication as a dictionary of operational terms and military symbols.

ADRP 1-02 is organized as follows:

- Chapter 1 presents terms.
- Chapter 2 presents acronyms and abbreviations.
- Chapter 3 introduces military symbology basics.
- Chapters 4 through 7 provide icons for units, individuals, organizations, equipment, installations, and activities.
- Chapter 8 introduces control measure symbols.
- Chapter 9 discusses tactical mission tasks.
- Chapter 10 discusses the course of action sketch.

Changes to terminology occur more frequently than traditional publication media can be updated. The terminology and symbology database, known as the Army Dictionary, is updated monthly to reflect the latest editions of Army publications. To access the database, go to <https://jdeis.js.mil/jdeis/index.jsp?pindex=207>, and login with a common access card. This database is an official DOD Web site, maintained by the Combined Arms Doctrine Directorate in collaboration with the Joint Staff Directorate for Joint Force Development. The site is part of the Joint Doctrine, Education, and Training Electronic Information System. It includes all Army doctrinal terms, and all military symbols in MIL-STD 2525C (air, land, maritime, space, activities control measures, and meteorological symbols). While the database includes the same joint terms appearing in ADRP 1-02, readers should consult Joint Publication (JP) 1-02 for up-to-date joint terminology.

The terminology entries in chapter 1 of this publication fall into two categories:

- Definitions applicable to the Army only.
- Joint (DOD) definitions commonly used in Army publications.

For each term and definition, a proponent publication is cited in parentheses after the definition.

***Definitions applicable to the Army only.*** The Army definition is preceded by “(Army)” if the term also has a joint definition that differs from the Army definition. The Army definition is followed by the proponent Army publication in parentheses, as in the following example:

**situational understanding** – The product of applying analysis and judgment to relevant information to determine the relationship among the operational and mission variables to facilitate decisionmaking. (ADP 5-0)

*Definitions that are joint (DOD) and appear in the glossaries of Army publications.* Each joint definition is preceded by "(DOD)." A cross-reference such as "See ADRP X-YY" follows the definition, signifying the publication discussing Army usage of the term, as in the following example:

**airspace control** – (DOD) A process used to increase operational effectiveness by promoting the safe, efficient, and flexible use of airspace. (JP 3-52) See ADRP 3-90, ADRP 5-0, and FM 3-90-1.

In addition, two other descriptors may appear after a definition:

- Also called.
- See also.

*Also called.* If a term has a shortened form (acronym or abbreviation) approved for doctrinal use, that form appears after the definition, preceded by *also called*, as in the following example:

**after action review** – A guided analysis of an organization's performance, conducted at appropriate times during and at the conclusion of a training event or operation with the objective of improving future performance. It includes a facilitator, event participants, and other observers. Also called AAR. (ADRP 7-0)

*See also.* If related terms are defined elsewhere in ADRP 1-02, they are cross-referenced after the definition. The related terms are bolded and preceded by "See also," as in the following example:

**area security** – A security task conducted to protect friendly forces, installation routes, and actions within a specific area. (ADRP 3-90) See also **area reconnaissance; security operations; rear area security**.

The acronym and abbreviation entries listed in section I of chapter 2 are Army and joint. Shortened forms applicable only to Army doctrine are shown in boldface, to distinguish Army from joint usage.

The symbology chapters (chapters 3 through 10) provide detailed requirements for composing and constructing symbols. The rules for building a set of military symbols allow enough flexibility for users to create any symbol to meet their operational needs. Although this publication serves as the Army proponent for military symbols, within DOD, MIL-STD 2525C is the proponent for military symbols. All symbols shown in this publication appear in MIL-STD 2525C. This publication compiles control measure symbols. It includes information omitted from FM 1-02 (2004) about building symbols. Readers can find defined terms used for symbology in chapter 1, including cross-references to publications that discuss usage of control measure symbols. All control measure symbols in this publication are linked to doctrine.

Readers are asked to refer to FM 1-02 only for procedure words during the Doctrine 2015 transition. A revision of ADRP 1-02 late in 2013 is expected to incorporate procedure words and supersede FM 1-02.



## Chapter 1

# Military Terms

This chapter presents selected military terms.

### —A—

- access control point** – A corridor at the installation entrance through which all vehicles and pedestrians must pass when entering or exiting the installation. (ATTP 3-39.32)
- acknowledge** – A directive from the originator of a communication requiring the addressee(s) to advise the originator that his communication has been received and understood. This term is normally included in the electronic transmission of orders to ensure the receiving station or person confirms the receipt of the order. (FM 6-02.53)
- actions on contact** – A series of combat actions, often conducted simultaneously, taken upon contact with the enemy to develop the situation. (ADRP 3-90)
- active air defense** – (DOD) Direct defensive action taken to destroy, nullify, or reduce the effectiveness of hostile air and missile threats against friendly forces and assets. (JP 3-01) See ADRP 3-09, ADRP 3-90, FM 3-90-1, and ATP 3-27.5.
- activity** – (DOD) 1. A unit, organization, or installation performing a function or mission. 2. A function, mission, action, or collection of actions. Also called ACT. (JP 3-0) See ATP 3-55.12.
- administrative contracting officer** – Contracting officers whose duties are limited to contract administration. Also called ACO. (ATTP 4-10)
- administrative control** – (DOD) Direction or exercise of authority over subordinate or other organizations in respect to administration and support, including organization of Service forces, control of resources and equipment, personnel management, unit logistics, individual and unit training, readiness, mobilization, demobilization, discipline, and other matters not included in the operational missions of the subordinate or other organizations. Also called ADCON. (JP 1) See ADRP 5-0.
- administrative movement** – A movement in which troops and vehicles are arranged to expedite their movement and conserve time and energy when no enemy ground interference is anticipated. (FM 3-90-2)
- adversary** – (DOD) A party acknowledged as potentially hostile to a friendly party and against which the use of force may be envisaged. (JP 3-0) See ADRP 3-0, ADRP 3-37, FM 3-07, and ATP 3-07.5.
- after action review** – A guided analysis of an organization's performance, conducted at appropriate times during and at the conclusion of a training event or operation with the objective of improving future performance. It includes a facilitator, event participants, and other observers. Also called AAR. (ADRP 7-0)
- agility** – The ability of friendly forces to react faster than the enemy. (ADRP 3-90)
- air and missile defense** – (DOD) Direct [active and passive] defensive actions taken to destroy, nullify, or reduce the effectiveness of hostile air and ballistic missile threats against friendly forces and assets. Also called AMD. (JP 3-01) See ATP 3-27.5. (Army) The direct defensive actions taken to protect friendly forces by destroying or reducing the effectiveness of hostile air and ballistic missile threats against friendly forces and assets in support of joint force commanders' objectives. (ADRP 3-09)
- air assault** – (DOD) The movement of friendly assault forces by rotary-wing aircraft to engage and destroy enemy forces or to seize and hold key terrain. (JP 3-18) See FM 3-90-1.

**airborne mission coordinator** – (DOD) The designated individual that serves as an airborne extension of the component commander or supported commander responsible for the personnel recovery mission. Also called AMC. (JP 3-50) See ATP 3-55.6.

**air defense** – (DOD) Defensive measures designed to destroy attacking enemy aircraft or missiles in the atmosphere, or to nullify or reduce the effectiveness of such attack. Also called AD. (JP 3-01) See FM 3-01.7.

**air defense artillery** – The defensive measures designated to destroy attacking enemy aircraft or missiles in the atmosphere, or to nullify or reduce the effectiveness of such attack either through surveillance actions or active engagements of aerial threat. (ADRP 3-09)

**air interdiction** – (DOD) Air operations conducted to divert, disrupt, delay, or destroy the enemy's military surface capabilities before it can be brought to bear effective against friendly forces, or to otherwise achieve objectives that are conducted at such distances from friendly forces that detailed integration of each air mission with the fire and movement of friendly forces is not required. (JP 3-03) See ATP 3-55.6.

**air movements** – (Army) Operations involving the use of utility and cargo rotary-wing assets for other than air assaults. (FM 3-90-2)

**airspace control** – (DOD) A process used to increase operational effectiveness by promoting the safe, efficient, and flexible use of airspace. (JP 3-52) See ADRP 3-90, ADRP 5-0, and FM 3-90-1.

**airspace control area** – (DOD) Airspace that is laterally defined by the boundaries of the operational area, and may be subdivided into airspace control sectors. (JP 3-01) See FM 3-52.

**airspace control authority** – (DOD) The commander designated to assume overall responsibility for the operation of the airspace control system in the airspace control area. Also called ACA. (JP 3-52) See FM 3-52.

**airspace control order** – (DOD) An order implementing the airspace control plan that provides the details of the approved requests for airspace coordinating measures. It is published either as part of the air tasking order or as a separate document. Also called ACO. (JP 3-52) See FM 3-52, ATP 3-06.1, and ATTP 2-01.

**airspace coordinating measures** – (DOD) Measures employed to facilitate the efficient use of airspace to accomplish missions and simultaneously provide safeguards for friendly forces. Also called ACMs. (JP 3-52) See FM 3-52.

**airspace coordination area** – (DOD) A three-dimensional block of airspace in a target area, established by the appropriate ground commander, in which friendly aircraft are reasonably safe from friendly surface fires. The airspace coordination area may be formal or informal. Also called ACA. (JP 3-09.3) See FM 3-52 and ATP 3-09.24.

**air support operations center** – (DOD) The principal air control agency of the theater air control system responsible for the direction and control of air operations directly supporting the ground combat element. It coordinates air missions requiring integration with other supporting arms and ground forces. It normally collocates with the Army tactical headquarters senior fire support coordination center within the ground combat element. Also called ASOC. (JP 3-09.3) See FM 3-52.

**air tasking order** – (DOD) A method used to task and disseminate to components, subordinate units, and command and control agencies projected sorties, capabilities and/or forces to targets and specific missions. Normally provides specific instructions to include call signs, targets, controlling agencies, etc., as well as general instructions. Also called ATO. (JP 3-30) See ATTP 2-01 and ATP 3-06.1.

**alliance** – (DOD) The relationship that results from a formal agreement between two or more nations for broad, long-term objectives that further the common interests of the members. (JP 3-0) See ADRP 3-0 and FM 3-07.

**allocation** – (DOD) Distribution of limited forces and resources for employment among competing requirements. (JP 5-0) See ATTP 2-01.

**all-source intelligence** – (DOD) 1. Intelligence products and/or organizations and activities that incorporate all sources of information, most frequently including human intelligence, imagery intelligence, measurement

and signature intelligence, signals intelligence, and open-source data in the production of finished intelligence. 2. In intelligence collection, a phrase that indicates that in the satisfaction of intelligence requirements, all collection, processing, exploitation, and reporting systems and resources are identified for possible use and those most capable are tasked. See also **intelligence**. (JP 2-0) See ATP 3-05.20. (Army) The integration of intelligence and information from all relevant sources to analyze situations or conditions that impact operations. (ADRP 2-0)

**alternate position** – A defensive position that the commander assigns to a unit or weapon for occupation when the primary position becomes untenable or unsuitable for carrying out the assigned task. (ADRP 3-90)

**alternate supply route** – A route or routes designated within an area of operations to provide for the movement of traffic when main supply routes become disabled or congested. Also called ASR. (ADRP 1-02) See also **area of operations; main supply route**.

**ambush** – An attack by fire or other destructive means from concealed positions on a moving or temporarily halted enemy. (FM 3-90-1)

**ammunition transfer holding point** – A designated site operated by a brigade support battalion distribution company where ammunition is received and transferred to supported units within a brigade combat team. May also temporarily hold or store ammunition as required. Also called ATHP. (ADRP 1-02)

**anticipation** – The ability to foresee operational requirements and initiate actions that satisfy a response without waiting for an operation order or fragmentary order. (ADP 4-0)

**apportionment** – (DOD) In the general sense, distribution of forces and capabilities as the starting point for planning. (JP 5-0) See ATTP 2-01.

**approach march** – The advance of a combat unit when direct contact with the enemy is intended. (ADRP 3-90)

**area air defense commander** – (DOD) The component commander with the preponderance of air defense capability and the required command, control, and communications capabilities who is assigned by the joint force commander to plan and execute integrated air defense operations. Also called AADC. (JP 3-01) See ATP 3-27.5.

**area defense** – A defensive task that concentrates on denying enemy forces access to designated terrain for a specific time rather than destroying the enemy outright. (ADRP 3-90)

**area of influence** – (DOD) A geographical area wherein a commander is directly capable of influencing operations by maneuver or fire support systems normally under the commander's command or control. (JP 3-0) See ADRP 3-0, ADRP 3-90, and FM 3-90-1.

**area of interest** – (DOD) That area of concern to the commander, including the area of influence, areas adjacent thereto, and extending into enemy territory. This area also includes areas occupied by enemy forces who could jeopardize the accomplishment of the mission. Also called AOI. (JP 3-0) See ADP 3-0, ADRP 3-90, FM 3-90-1, and ATP 3-55.6.

**area of operations** – (DOD) An operational area defined by the joint force commander for land and maritime forces that should be large enough to accomplish their missions and protect their forces. Also called AO. (JP 3-0) See ADRP 3-0, ADRP 3-90, ATP 3-09.24, ATP 3-55.6, FM 3-90-1, and FM 3-07.

**area of responsibility** – (DOD) The geographical area associated with a combatant command within which a geographic combatant commander has authority to plan and conduct operations. Also called AOR. (JP 1) See ATP 3-55.6.

**area reconnaissance** – A form of reconnaissance that focuses on obtaining detailed information about the terrain or enemy activity within a prescribed area. (ADRP 3-90)

**area security** – A security task conducted to protect friendly forces, installation routes, and actions within a specific area. (ADRP 3-90) See also **area reconnaissance; security operations; rear area security**.

**area support** – Method of logistics, medical support, and personnel services in which support relationships are determined by the location of the units requiring support. Sustainment units provide support to units located in or passing through their assigned areas. (FM 4-90) See also **direct support; logistics**.

**ARFOR** – The Army component and senior Army headquarters of all Army forces assigned or attached to a combatant command, subordinate joint force command, joint functional command, or multinational command. (ADRP 1-02)

**Army Civilian Corps** – The non-uniformed Department of the Army civilian members of the Army Profession. (ADRP 1)

**Army design methodology** – A methodology for applying critical and creative thinking to understand, visualize, and describe unfamiliar problems in approaches to solving them. (ADP 5-0)

**Army ethic** – The evolving set of laws, values, and beliefs, deeply embedded within the core of the Army culture and practiced by all members of the Army Profession to motivate and guide the appropriate conduct of individual members bound together in common moral purpose. (ADRP 1)

**Army field support brigade** – An organization which provides integrated and synchronized acquisition logistics and technology support, less medical, to Army operational forces. Also called AFSB. (ADRP 1-02)

**Army Health System** – A component of the Military Health Systems that is responsible for operational management of the health service support and force health protection missions for training, predeployment, deployment, and postdeployment operations. (FM 4-02)

**Army leader** – Anyone who by virtue of assumed role or assigned responsibility inspires and influences people to accomplish organizational goals. Army leaders motivate people both inside and outside the chain of command to pursue actions, focus thinking, and shape decisions for the greater good of the organization. (ADP 6-22)

**Army Profession** - A unique vocation of experts certified in the design, generation, support, and ethical application of landpower, serving under civilian authority and entrusted to defend the Constitution and the rights and interests of the American people. (ADRP 1)

**Army professional** - A member of the Army Profession who meets the Army's certification criteria of competence, character, and commitment. (ADRP 1)

**Army special operations aviation** – Designated Active Component forces and units organized, trained, and equipped specifically to conduct air mobility, close combat attack, and other special air operations. (ADRP 3-05)

**Army special operations forces** – (DOD) Those Active and Reserve Component Army forces designated by the Secretary of Defense that are specifically organized, trained, and equipped to conduct and support special operations. Also called ARSOF. (JP 3-05) See FM 3-05.

**art of command** – The creative and skillful exercise of authority through timely decisionmaking and leadership. (ADP 6-0)

**art of tactics** – This consists of three interrelated aspects: the creative and flexible array of means to accomplish assigned missions, decisionmaking under conditions of uncertainty when faced with a thinking and adaptive enemy, and understanding the effects of combat on Soldiers. (ADRP 3-90)

**assailable flank** – A flank which is exposed to attack or envelopment. (ADRP 3-90) See also **flank**.

**assault echelon** – (Army) The element of a force that is scheduled for initial assault on the objective area. (ADRP 1-02)

**assault position** – A covered and concealed position short of the objective, from which final preparations are made to assault the objective. (ADRP 3-90)

**assault time** – The moment to attack the initial objective throughout the geographical scope of the operation. (ADRP 3-90)

**assembly area** – (Army) An area a unit occupies to prepare for an operation. (FM 3-90-1)

**assessment** – (DOD) 1. A continuous process that measures the overall effectiveness of employing joint force capabilities during military operations. See FM 3-07. 2. Determination of the progress toward

accomplishing a task, creating a condition, or achieving an objective. (JP 3-0) See ADP 3-37, ADRP 3-37, ADP 5-0 and ARDRP 5-0. 3. Analysis of the security, effectiveness, and potential of an existing or planned intelligence activity. 4. Judgment of the motives, qualifications, and characteristics of present or prospective employees or "agents." See FM 3-07.

**assign** – (DOD) 1. To place units or personnel in an organization where such placement is relatively permanent, and/or where such organization controls and administers the units or personnel for the primary function, or greater portion of the functions, of the unit or personnel. (JP 3-0) See ADRP 5-0.

**assured mobility** – A framework—of processes, actions, and capabilities—that assures the ability of a force to deploy, move, and maneuver where and when desired, without interruption or delay, to achieve the mission. (ATTP 3-90.4)

**attach** – (DOD) 1. The placement of units or personnel in an organization where such placement is relatively temporary. (JP 3-0) See ADRP 5-0.

**attack** – An offensive task that destroys or defeats enemy forces, seizes and secures terrain, or both (ADRP 3-90) See **also defeat; deliberate attack; demonstration; destroy; feint; offensive operations; raid; secure; seize; spoiling attack.**

**attack by fire** – A tactical mission task in which a commander uses direct fires, supported by indirect fires, to engage an enemy force without closing with the enemy to destroy, suppress, fix, or deceive that enemy. (FM 3-90-1) See also **destroy; fix; frontal attack; support by fire; suppress; tactical mission task.**

**attack by fire position** – The general position from which a unit conducts the tactical task of attack by fire. (ADRP 3-90) See also **attack by fire.**

**attack position** – (Army) The last position an attacking force occupies or passes through before crossing the line of departure. (ADRP 3-90)

**attitudes** – The beliefs, feelings, values, and disposition that cause an individual to respond in a particular way to a given object, person, or situation. (FM 3-05.301)

**authenticate** – (DOD) A challenge given by voice or electrical means to attest to the authenticity of a person, message, or transmission. (JP 3-50) See ATP 3-50.3.

**authority** – The delegated power to judge, act or command. (ADP 6-0)

**auxiliary** – For the purpose of unconventional warfare, the support element of the irregular organization whose organization and operations are clandestine in nature and whose members do not openly indicate their sympathy or involvement with the irregular movement. (ADRP 3-05)

**avenue of approach** – (Army) The air or ground route leading to an objective (or key terrain in its path) that an attacking force can use. (ADRP 3-90)

**axis of advance** – (Army) The general area through which the bulk of a unit's combat power must move. (ADRP 3-90) See also **attack; movement to contact; offensive operations.**

—B—

**backbrief** – A briefing by subordinates to the commander to review how subordinates intend to accomplish their mission. (ATTP 5-0.1) See also **mission.**

**ballistic missile** – (DOD) Any missile which does not rely upon aerodynamic surfaces to produce lift and consequently follows a ballistic trajectory when thrust is terminated. (JP 3-01) ATP 3-27.5.

**base** – (DOD) A locality from which operations are projected or supported. (JP 4-0) See ADRP 3-0.

**base camp** – An evolving military facility that supports that military operations of a deployed unit and provides the necessary support and services for sustained operations. (ATP 3-37.10)

**base defense** – (DOD) The local military measures, both normal and emergency, required to nullify or reduce the effectiveness of enemy attacks on, or sabotage of, a base, to ensure that the maximum capacity of its facilities is available to U.S. forces. (JP 3-10) See ADRP 3-37.

**basic load (ammunition)** – (Army) The quantity of nonnuclear ammunition that is authorized and required by each Service to be on hand for a unit to meet combat needs until resupply can be accomplished. It is expressed in rounds, units or unity of weight, as appropriate. (FM 3-01.7)

**battalion** – A unit consisting of two or more company-, battery-, or troop-size units and a headquarters. (ADRP 3-90) See also **battery; company**.

**battalion task force** – A maneuver battalion-size unit consisting of a battalion headquarters, at least one assigned company-size element, and at least one attached company-size element from another maneuver or support unit (functional and multifunctional). (ADRP 3-90)

**battery** – A company-size unit in a fires or air defense artillery battalion. (ADRP 3-90)

**battle** – A set of related engagements that lasts longer and involves larger forces than an engagement. (ADRP 3-90) See also **campaign; engagement; major operation**.

**battle damage assessment** – (DOD) The estimate of damage composed of physical and functional damage assessment, as well as target system assessment, resulting from the application of lethal or nonlethal military force. Also called BDA. (JP 3-0) See ATP 3-55.6 and ATP 3-60.1.

**battle handover line** – A designated phase line on the ground where responsibility transitions from the stationary force to the moving force and vice versa. Also called BHL. (ADRP 3-90) See also **handover line; phase line**.

**battle management** – (DOD) The management activities within the operational environment based on the commands, direction, and guidance given by appropriate authority. Also called BM. (JP 3-01) See ATP 3-27.5.

**battle position** – 1. A defensive location oriented on a likely enemy avenue of approach. (ADRP 3-90) 2. For attack helicopters, an area designated in which they can maneuver and fire into a designated engagement area or engage targets of opportunity. Also called BP. (ADRP 1-02) See also **airspace coordination area; avenue of approach**.

**battle rhythm** – A deliberate cycle of command, staff, and unit activities intended to synchronize current and future operations. (ADRP 1-02)

**be-prepared mission** – A mission assigned to a unit that might be executed. (ATTP 5-0.1) See also **on-order mission**.

**biological weapon** – (DOD) An item of material which projects, disperses, or disseminates a biological agent including arthropod vectors. (JP 3-11) See ATP 4-02.84.

**biometrics-enabled intelligence** – The information associated with and/or derived from biometric signatures and the associated contextual information that positively identifies a specific person and/or matches an unknown identity to a place, activity, device, component, or weapon. (ADRP 1-02)

**block** – A tactical mission task that denies the enemy access to an area or prevents his advance in a direction or along an avenue of approach. Block is also an obstacle effect that integrates fire planning and obstacle effort to stop an attacker along a specific avenue of approach or to prevent the attacking force from passing through an engagement area. (FM 3-90-1) See also **avenue of approach; contain; disrupt; fix; tactical mission task; turn**.

**board** – (Army) A grouping of predetermined staff representatives with delegated decision authority for a particular purpose or function. (ATTP 5-0.1) See also **working group, battle rhythm**.

**boost phase** – (DOD) That portion of the flight of a ballistic missile or space vehicle during which the booster and sustainer engines operate. (JP 3-01) See ATP 3-27.5.

**boundary** – (DOD) A line that delineates surface areas for the purpose of facilitating coordination and deconfliction of operations between adjacent units, formations, or areas. (JP 3-0) See FM 3-90-1.

**bounding overwatch** – A movement technique used when contact with enemy forces is expected. The unit moves by bounds. One element is always halted in position to overwatch another element while it moves. The overwatching element is positioned to support the moving unit by fire or fire and movement. (FM 3-90-2)

**box formation** – A unit formation with subordinate elements arranged in a box or square, or two elements up and two elements back. It is a flexible formation that provides equal firepower in all directions. It is generally used when the enemy location is known. This formation can cause 50 percent of force to be decisively engaged at the same time, therefore limiting the combat power available to maneuver against an enemy. (FM 3-90-1) See also **column formation; echelon formation**.

**branch** – (DOD) 1. A subdivision of any organization. 2. A geographically separate unit of an activity, which performs all or part of the primary functions of the parent activity on a smaller scale. 3. An arm or service of the Army. 4. The contingency options built into the base plan used for changing the mission, orientation, or direction of movement of a force to aid success of the operation based on anticipated events, opportunities, or disruptions caused by enemy actions and reactions. (JP 5-0) See FM 3-07.

**breach** – A tactical mission task in which the unit employs all available means to break through or establish a passage through an enemy defense, obstacle, minefield, or fortification. (FM 3-90-1) See also **tactical mission task**.

**breach area** – The area where a breaching operation occurs. It is established and fully defined by the higher headquarters of the unit conducting breaching operations. (ATTP 3-90.4) See also **breaching operation**.

**breaching operation** – Operation conducted to allow maneuver despite the presence of obstacles. Breaching is a synchronized combined arms operation under the control of the maneuver commander. Breaching operations begin when friendly forces detect an obstacle and begin to apply the breaching fundamentals, and they end when battle handover has occurred between follow-on forces and a unit conducting the breaching operation. (ATTP 3-90.4) See also **follow-on forces**.

**breakout** – An operation conducted by an encircled force to regain freedom of movement or contact with friendly units. It differs from other attacks only in that a simultaneous defense in other areas of the perimeter must be maintained. (ADRP 3-90) See also **encirclement; follow and support; main body**.

**breakthrough** – A rupturing of the enemy's forward defenses that occurs as a result of a penetration. A breakthrough permits the passage of an exploitation force. (FM 3-90-1) See also **attack; exploitation; penetration**.

**bridgehead** – In gap crossing operations, an area on the enemy's side of the linear obstacle that is large enough to accommodate the majority of the crossing force, has adequate terrain to permit defense of the crossing sites, provides security of crossing forces from enemy direct fire, and provides a base for continuing the attack. (ATTP 3-90.4) See also **crossing site**.

**bridgehead force** – A force that assaults across a gap to secure the enemy side (the bridgehead) to allow the buildup and passage of a breakout force during river crossing operations. (ATTP 3-90.4) See also **bridgehead**.

**brigade** – A unit consisting of two or more battalions and a headquarters company or detachment. (ADRP 3-90) See also **battalion; division**.

**brigade combat team** – (Army) A combined arms organization consisting of a brigade headquarters, at least two maneuver battalions, and necessary supporting functional capabilities. Also called BCT. (ADRP 3-90)

**bypass** – A tactical mission task in which the commander directs his unit to maneuver around an obstacle, position, or enemy force to maintain the momentum of the operation while deliberately avoiding combat with an enemy force. (FM 3-90-1) See also **tactical mission task**.

**bypass criteria** – Measures during the conduct of an offensive operation established by higher headquarters that specify the conditions and size under which enemy units and contact may be avoided. (ADRP 3-90) See also **bypass**.

—C—

- call for fire** – A request for fire containing data necessary for obtaining the required fire on a target. Also called CCF. (FM 3-09)
- call forward area** – In gap-crossing operations, waiting areas within the crossing area where final preparations are made. (ATTP 3-90.4)
- campaign** – (DOD) A series of related major operations aimed at achieving strategic and operational objectives within a given time and space. (JP 5-0) See ADRP 3-0 and ATP 3-07.5.
- canalize** – (Army) A tactical mission task in which the commander restricts enemy movement to a narrow zone by exploiting terrain coupled with the use of obstacles, fires, or friendly maneuver. (FM 3-90-1) See also **tactical mission task**.
- capacity building** – The process of creating an environment that fosters host-nation institutional development, community participation, human resources development, and strengthening of managerial systems. (FM 3-07)
- casualty evacuation** – (DOD) The unregulated movement of casualties that can include movement both to and between medical treatment facilities. Also called CASEVAC. (JP 4-02) See ATP 3-55.6.
- casualty operations** – The process of recording, reporting, verifying, and processing casualty information from unit level to Headquarters, Department of the Army; notifying appropriate individuals and agencies; and providing casualty notification and assistance to the primary next of kin. (ATP 1-0.2)
- catastrophic event** – (DOD) Any natural or man-made incident, including terrorism, which results in extraordinary levels of mass casualties, damage, or disruption severely affecting the population, infrastructure, environment, economy, national morale, and/or government functions. (JP 3-28) See ADRP 3-28.
- center of gravity** – (DOD) The source of power that provides moral or physical strength, freedom of action, or will to act. Also called COG. (JP 5-0) See ADRP 3-0 and ATP 3-05.20.
- certification** – Verification and validation of an Army professional's competence, character, and commitment to fulfill responsibilities and perform assigned duties with discipline and to standard. (ADRP 1)
- character** – An Army professional's dedication and adherence to the Army Values and the profession's ethic as consistently and faithfully demonstrated in decisions and actions. (ADRP 1)
- checkpoint** – A predetermined point on the ground used to control movement, tactical maneuver, and orientation. (ADRP 1-02)
- chemical, biological, radiological, and nuclear defense** – (DOD) Measures taken to minimize or negate the vulnerabilities and/or effects of a chemical, biological, radiological, or nuclear incident. Also called CBRN defense. (JP 3-11) See ATP 4-02.84.
- chemical, biological, radiological, or nuclear incident** – (DOD) Any occurrence, resulting from the use of chemical, biological radiological and nuclear weapons and devices; the emergence of secondary hazards arising from counterforce targeting; or the release of toxic industrial materials into the environment, involving the emergence of chemical biological, radiological and nuclear hazards. (JP 3-11) See ADP 3-28 and ATP 3-55.6.
- chemical, biological, radiological, or nuclear sample management** – Chemical, biological, radiological, or nuclear (CBRN) sample management is the process whereby CBRN samples are collected, packaged, transported, stored, transferred, analyzed, tracked, and disposed. It begins with the decision to collect CBRN samples and continues to the reporting of information produced by the final analysis of that sample. This process includes safeguarding and prioritizing CBRN samples, tracking their movements and analytical status, and reporting the end result of sample analysis. The CBRN sample management process establishes procedures, guidelines, and constraints at staff and unit levels to protect and preserve the integrity of CBRN samples that may have tactical, operational, and/or strategic implications. (ATP 3-11.37)



**chief of fires** – The senior fires officer at division and higher headquarters level who is responsible for advising the commander on the best use of available fire support resources, providing input to necessary orders, and developing and implementing the fires support plan. (ADRP 3-09)

**civil administration** – (DOD) An administration established by a foreign government in (1) friendly territory, under an agreement with the government of the area concerned, to exercise certain authority normally the function of the local government; or (2) hostile territory, occupied by United States forces, where a foreign government exercises executive, legislative, and judicial authority until an indigenous civil government can be established. Also called CA. (JP 3-05) See ATP 3-57.20 and FM 3-57.

**civil affairs** – (DOD) Designated Active and Reserve Component forces and units organized, trained, and equipped specifically to conduct civil affairs operations and to support civil-military operations. Also called CA. (JP 3-57) See ADRP 3-05, FM 3-57, and ATP 3-57.20.

**civil affairs operations** – (DOD) Those military operations conducted by civil affairs forces that (1) enhance the relationship between military forces and civil authorities in localities where military forces are present; (2) require coordination with other interagency organizations, intergovernmental organizations, nongovernmental organizations, indigenous populations and institutions, and the private sector; and (3) involve application of functional specialty skills that normally are the responsibility of civil government to enhance the conduct of civil-military operations. Also called CAO. (JP 3-57) See ADRP 3-05, ATP 1-06.2, ATP 3-09.24, ATP 3-57.20, FM 1-04, FM 3-07, and FM 3-57.

**civil affairs operations project management** – The six step process by which civil affairs forces identify, validate, plan, coordinate, facilitate, and monitor both material and nonmaterial civil affairs operations projects to achieve a supported commander's objectives relating to the civil component of the operational environment. (FM 3-57)

**civil assistance** – Assistance, based on a commander's decision, in which life-sustaining services are provided, order is maintained, and/or goods and services are distributed within the commander's assigned area of operations. (FM 3-57)

**civil authorities** – (DOD) Those elected and appointed officers and employees who constitute the government of the United States, the governments of the 50 states, the District of Columbia, the Commonwealth of Puerto Rico, United States possessions and territories, and political subdivisions thereof. (JP 3-28) See ADP 3-28.

**civil augmentation program** – (DOD) Standing, long-term external support contracts designed to augment Service logistic capabilities with contract support in both preplanned and short notice contingencies. Examples include US Army Logistics Civil Augmentation Program, Air Force Contract Augmentation Program, and US Navy Global Contingency Capabilities Contracts. Also called CAP. (JP 4-10) See ATP 4-10.

**civil considerations** – The influence of manmade infrastructure, civilian institutions, and attitudes and activities of the civilian leaders, populations, and organizations within an area of operations on the conduct of military operations. (ADRP 5-0)

**civilian internee** – (DOD) A civilian who is interned during armed conflict, occupation, or other military operation for security reasons, for protection, or because he or she committed an offense against the detaining power. Also called CI. (DODD 2310.01E) See FM 1-04.

**civil information** – Information developed from data with relation to civil areas, structures, capabilities, organization, people, and events within civil component of the commander's operational environment that can be fused or processed to increase Department of Defense/interagency/intergovernmental organizations/nongovernmental organizations/indigenous populations and institutions situational awareness, situational understanding, or situational dominance. (FM 3-57)

**civil information management** – Process whereby civil information is collected, entered into a central database, and internally fused with the supported element, higher headquarters, other United States Government and Department of Defense agencies, to ensure the timely availability of information for analysis and the widest possible dissemination of the raw and analyzed civil information to military and nonmilitary partners throughout the area of operations. Also called CIM. (FM 3-57)

**civil liaison team** – Provides limited civil-military interface capability as a spoke for exchange of information between indigenous populations and institutions, intergovernmental organizations, nongovernmental organizations, and other governmental agencies, and has limited capability to link resources to prioritized requirements. The civil liaison team is a stand-alone team for the civil-military operations center. It provides the supported level civil-military operations center with a storefront for civil affairs operations and civil-military operations coordination capability without interfering with the regular staff functions. Also called CLT. (FM 3-57)

**civil-military engagement** – A formal program that facilitates the U.S. interagency, host nation indigenous authorities, select intergovernmental and nongovernmental partners, and the private sector to build, replace, repair, and sustain civil capabilities and capacities that eliminate, reduce, or mitigate civil vulnerabilities or local regional populations. Civil-military engagement is a globally synchronized and regionally coordinated program of country-specific and regional actions executed through and with indigenous and U.S. interagency partners to eliminate the underlying conditions and core motivations for local and regional population support to violent extremist organizations and the networks. Also called CME. (FM 3-57)

**civil-military operations** – (DOD) The activities of a commander that establish, maintain, influence, or exploit relations between military forces, governmental and nongovernmental civilian organizations and authorities, and the civilian populace in a friendly, neutral, or hostile operational area in order to facilitate military operations, to consolidate and achieve operational US objectives. Civil-military operations may include performance by military forces of activities and functions normally the responsibility of the local, regional, or national government. These activities may occur prior to, during, or subsequent to other military actions. They may also occur, if directed, in the absence of other military operations. Civil-military operations may be performed by designated civil affairs, by other military forces, or by a combination of civil affairs and other forces. Also called CMO. (JP 3-57) See ADRP 3-05, ATP 3-57.20, and FM 3-57.

**civil-military operations center**– (DOD) An organization normally comprised of civil affairs, established to plan and facilitate coordination of activities of the Armed Forces of the United States with indigenous populations and institutions, the private sector, intergovernmental organizations, nongovernmental organizations, multinational forces, and other governmental agencies in support of the joint force commander. Also called CMOC. (JP 3-57) See ATP 3-57.20 and FM 3-57.

**civil-military support element** – A tasked-organized civil affairs force that conducts civil-military engagement in a specified country or region. A civil-military support element is composed of a persistent-presence element of civil affairs leaders/planners, and a presence-for-purpose element composed of a civil affairs team(s) that may include enablers (for example, health service support, engineer, etc.) who are task organized for a specific time to execute a coordination mission. Also called CMSE. (FM 3-57)

**civil reconnaissance** – A targeted, planned, and coordinated observation and evaluation of those specific civil aspects of the environment. Civil reconnaissance focuses specifically on the civil component, the elements of which are best represented by the mnemonic ASCOPE: areas, structures, capabilities, organizations, people, and events. Civil reconnaissance can be conducted by civil affairs or by other forces, as required. Also called CR. (FM 3-57)

**clandestine** – (DOD) Any activity or operation sponsored or conducted by governmental departments or agencies with the intent to assure secrecy and concealment. (JP 1-02) See ATP 3-05.20.

**classes of supply** – (DOD) The ten categories into which supplies are grouped in order to facilitate supply management and planning. I. Rations and gratuitous issue of health, morale, and welfare items. II. Clothing, individual equipment, tentage, tool sets, and administrative and housekeeping supplies and equipment. III. Petroleum, oils, and lubricants. IV. Construction materials. V. Ammunition. VI. Personal demand items. VII. Major end items, including tanks, helicopters, and radios. VIII. Medical. IX. Repair parts and components for equipment maintenance. X. Nonstandard items to support nonmilitary programs such as agriculture and economic development. (JP 4-09) [*Note*: Army doctrine also includes a miscellaneous category comprising water, captured enemy material, and salvage material.] See ADRP 4-0.

**clear** – 1. A tactical mission task that requires the commander to remove all enemy forces and eliminate organized resistance within an assigned area. (FM 3-90-1) 2. To eliminate transmissions on a tactical radio net in order to allow a higher-precedence transmission to occur. (FM 6-02.53) 3. The total elimination or

neutralization of an obstacle that is usually performed by follow-on engineers and is not done under fire. (ATTP 3-90.4) See also **reduce; tactical mission task**.

**clearance of fires** – The process of approving or obtaining approval to attack targets with fires within and outside the boundaries of the supported unit for which the fires are provided. (FM 3-09)

**close air support** – (DOD) Air action by fixed- and rotary-wing aircraft against hostile targets that are in close proximity to friendly forces and that require detailed integration of each air mission with the fire and movement of those forces. Also called CAS. (JP 3-0) See ATP 3-06.1, ATP 3-09.24, ATP 3-55.6, and FM 3-52.

**close area** – In contiguous areas of operations, an area assigned to a maneuver force that extends from its subordinates' rear boundaries to its own forward boundary. (ADRP 3-0)

**close combat** – Warfare carried out on land in a direct-fire fight, supported by direct and indirect fires, and other assets. (ADRP 3-0)

**close quarters battle** – Sustained combative tactics, techniques, and procedures employed by small, highly trained special operations forces using special purpose weapons, munitions, and demolitions to recover specified personnel, equipment, or material. (ADRP 3-05)

**coalition** – (DOD) An arrangement between two or more nations for common action. (JP 5-0) See ADRP 3-0 and FM 3-07.

**collaborative planning** – Commanders, subordinate commanders, staffs, and other partners sharing information, knowledge, perceptions, ideas, and concepts regardless of physical location throughout the planning process. (ADRP 5-0)

**collateral damage** – (DOD) Unintentional or incidental injury or damage to persons or objects that would not be lawful military targets in the circumstances ruling at the time. (JP 3-60) See ATP 3-60.1 and ATP 3-06.1.

**collection management** – (DOD) In intelligence usage, the process of converting intelligence requirements into collection requirements, establishing priorities, tasking or 524coordinating with appropriate collection sources of agencies, monitoring results, and retasking, as required. (JP 2-0) See ATP 3-55.6.

**column formation** – The column formation is a combat formation in which elements are placed one behind the other. (FM 3-90-1)

**combatant command (command authority)** – (DOD) Nontransferable command authority, which cannot be delegated, of a combatant commander to perform those functions of command over assigned forces involving organizing and employing commands and forces; assigning tasks; designating objectives; and giving authoritative direction over all aspects of military operations, joint training, and logistics necessary to accomplish the missions assigned to the command. Also called COCOM. (JP 1) See ATP 3-27.5.

**combat camera** – (DOD) The acquisition and utilization of still and motion imagery in support of operational and planning requirements across the range of military operations and during joint exercises. Also called COMCAM. (JP 3-61) See ATP 3-55.12.

**combat engineering** – The engineer discipline that is focused on affecting terrain while in close support to maneuver forces that are in close combat. (FM 3-34)

**combat formation** – A combat formation is an ordered arrangement of forces for a specific purpose and the general configuration of a unit on the ground. (ADRP 3-90)

**combat identification** – (DOD) The process of attaining an accurate characterization of detected objects in the operational environment sufficient to support an engagement decision. Also called CID. (JP 3-09) See ATP 3-60.1.

**combat information** – (DOD) Unevaluated data, gathered by or provided directly to the tactical commander which, due to its highly perishable nature or the criticality of the situation, cannot be processed into tactical intelligence in time to satisfy the user's tactical intelligence requirements. (JP 2-01) See ADRP 2-0 and ADRP 3-90.

**combat load** – The minimum mission-essential equipment, as determined by the commander responsible for carrying out the mission, required for Soldiers or Marines to fight and survive immediate combat operations. (FM 10-1)

**combat observation and lasing team** – A field artillery team controlled at the brigade level that is capable of day and night target acquisition and has both laser range finding and laser-designating capabilities. (ADRP 3-09)

**combat power** – (DOD) The total means of destruction and/or disruptive force which a military unit/formation can apply against the opponent at a given time. (JP 3-0) See FM 3-07. (Army) The total means of destructive, constructive, and information capabilities that a military unit or formation can apply at a given time. (ADRP 3-0)

**combat outpost** – A reinforced observation post capable of conducting limited combat operations. (FM 3-90-2)

**combat search and rescue** – (DOD) The tactics, techniques, and procedures performed by forces to effect the recovery of isolated personnel during combat. Also called CSAR. (JP 3-50) See ADRP 3-05.

**combined arms** – The synchronized and simultaneous application of arms to achieve an effect greater than if each arm was used separately or sequentially. (ADRP 3-0)

**combined arms maneuver** – The application of the element of combat power in unified action to defeat enemy ground forces; to seize, occupy, and defend land areas; and to achieve physical, temporal, and psychological advantages over the enemy to seize and exploit the initiative. (ADP 3-0)

**combined arms team** – (Army) Two or more arms mutually supporting one another, usually consisting of a mixture of infantry, armor, aviation, field artillery, air defense artillery, and engineers. (ADRP 3-90)

**command** – (DOD) 1. The authority that a commander in the armed forces lawfully exercises over subordinates by virtue of rank or assignment. See ADRP 3-0, ADP 6-0, and ADP 6-22. 2. An order given by a commander; that is, the will of the commander expressed for the purpose of bringing about a particular action. 3. A unit or units, an organization, or an area under the command of one individual. Also called CMD. (JP 1). See FM 3-07.

**command and control** – (DOD) The exercise of authority and direction by a properly designated commander over assigned and attached forces in the accomplishment of the mission. Also called C2. (JP 1). See FM 3-07 and ATP 3-06.1.

**commander's critical information requirement** – (DOD) An information requirement identified by the commander as being critical to facilitating timely decision making. Also called CCIR. (JP 3-0) See ADRP 5-0 and ATP 3-09.24.

**commander's intent** – (DOD) A clear and concise expression of the purpose of the operation and the desired military end state that supports mission command, provides focus to the staff, and helps subordinate and supporting commanders act to achieve the commander's desired results without further orders, even when the operation does not unfold as planned. (JP 3-0) See ADRP 3-0, ADP 5-0, ADP 6-0, ADRP 6-0, ADRP 3-28, and FM 3-07.

**commander's visualization** – The mental process of developing situational understanding, determining desired end state, and envisioning an operational approach by which the force will achieve that end state. (ADP 5-0)

**command group** – The commander and selected staff members who assist the commander in controlling operations away from a command post. (ATTP 5-0.1) See also **mission command; commander; command post**.

**command post** – A unit headquarters where the commander and staff perform their activities. (ATTP 5-0.1) See also **commander; command group; main command post; tactical command post**.

**command post cell** – A grouping of personnel and equipment organized by warfighting function or by planning horizon to facilitate the exercise of mission command. (ATTP 5-0.1)

**commitment** – The resolve of Army professionals to contribute honorable service to the Nation, to perform their duties successfully with discipline and to standard, and to strive to successfully and ethically accomplish the mission despite adversity, obstacles, and challenges. (ADRP 1)

**committed force** – A force in contact with an enemy or deployed on a specific mission or course of action which precludes its employment elsewhere. (ADRP 3-90) See also **attack; decisive engagement**.

**common operational picture** – (Army) A single display of relevant information within a commander's area of interest tailored to the user's requirements and based on common data and information shared by more than one command. Also called COP. (ADRP 6-0)

**company** – A company is a unit consisting of two or more platoons, usually of the same type, with a headquarters and a limited capacity for self-support. (ADRP 3-90)

**company team** – A combined arms organization formed by attaching one or more nonorganic armor, mechanized infantry, Stryker infantry, or light infantry platoons to a tank, mechanized infantry, Stryker, or infantry company either in exchange for, or in addition to its organic platoons. (ADRP 3-90)

**competence** – An Army professional's demonstrated ability to perform his/her duties successfully and to accomplish the mission with discipline and to standard. (ADRP 1)

**complex terrain** – A geographical area consisting of an urban center larger than a village and/or of two or more types of restrictive terrain or environmental conditions occupying the same space. Restrictive terrain or environmental conditions include, but are not limited to, slope, high altitude, forestation, severe weather, and urbanization. (ATTP 3-34.80)

**comprehensive approach** – An approach that integrates the cooperative efforts of the departments and agencies of the United States Government, intergovernmental and nongovernmental organizations, multinational partners, and private sector entities to achieve unity of effort toward a shared goal. (FM 3-07)

**concealment** – Protection from observation or surveillance. See also **surveillance**. (ADRP 1-02)

**concept of operations** – (DOD) A verbal or graphic statement that clearly and concisely expresses what the joint force commander intends to accomplish and how it will be done using available resources. (JP 5-0) See ADRP 3-90, FM 3-07, and FM 3-90-1. (Army) A statement that directs the manner in which subordinate units cooperate to accomplish the mission and establish the sequence of actions the force will use to achieve the end state. (ADRP 5-0) See also **commander's intent; operation plan**.

**conduct human resources planning and operations** – The means by which human resources provider envisions a desired human resources end state in support of the operational commander's mission requirement. End state includes the intent, expected requirement, and outcomes to be achieved in the conduct and sustainment of human resources operations. Planning involves the use of the military decisionmaking process and composite risk management to ensure decisions are being made at the proper level of command. The end result is communicated to subordinates through an operation plan or operation order. (ATP 1-0.2)

**confirmation brief** – A briefing subordinate leaders give to the higher commander immediately after the operation order is given. It is their understanding of his intent, their specific tasks, and the relationship between their mission and the other units in the operation. (ADRP 5-0) See also **commander's intent; operation order**.

**conflict transformation** – The process of reducing the means and motivations for violent conflict while developing more viable, peaceful alternatives for the competitive pursuit of political and socio-economic aspirations. (FM 3-07)

**consolidation** – Organizing and strengthening in newly captured position so that it can be used against the enemy. (FM 3-90-1)

**constraint** – (Army) A restriction placed on the command by a higher command. A constraint dictates an action or inaction, thus restricting the freedom of action a subordinate commander. (ATTP 5-0.1)

**contact point** – (DOD) 1. In land warfare, a point on the terrain, easily identifiable, where two or more units are required to make contact. See FM 3-90-1. 2. In air operations, the position at which a mission leader makes

radio contact with an air control agency. 3. In personnel recovery, a location where isolated personnel can establish contact with recovery forces. Also called CP. (JP 3-50) See FM 3-05.231.

**contain** – A tactical mission task that requires the commander to stop, hold, or surround enemy forces or to cause them to center their activity on a given front and prevent them from withdrawing any part of their forces for use elsewhere. (FM 3-90-1)

**container management** – The process of establishing and maintaining visibility and accountability of all cargo containers moving within the Defense Transportation System. (ADP 4-0)

**contamination** – (DOD) 1. The deposit, absorption, or adsorption of radioactive material, or of biological or chemical agents on or by structures, areas, personnel, or objects. 2. Food and/or water made unfit for consumption by humans or animals because of the presence of environmental chemicals, radioactive elements, bacteria or organisms, the byproduct or the growth of bacteria or organisms, the decomposing material (to include the food substance itself), or waste in the food or water. (JP 3-11) See ATP 4-02.84.

**contamination control** – (DOD) A combination of preparatory and responsive measures designed to limit the vulnerability of forces to chemical, biological, radiological, nuclear, and toxic industrial hazards and to avoid, contain, control exposure to, and, where possible, neutralize them. (JP 3-11) See ATP 4-02.84.

**contiguous area of operations** – An area of operations where all of a commander's subordinate forces' areas of operations share one or more common boundary. (FM 3-90-1) See also **area of operations; boundary**.

**continuity** – The uninterrupted provision of sustainment. (ADP 4-0)

**contracting officer** – (DOD) The Service member or Department of Defense civilian with the legal authority to enter into, administer, and/or terminate contracts. (JP 4-10) See ATTP 4-10 and ATP 1-06.2.

**control** – (DOD) 1. Authority that may be less than full command exercised by a commander over part of the activities of subordinate or other organizations. (JP 1) 2. In mapping, changing, and photogrammetry, a collective term for a system of marks or objects on the Earth or on a map or photograph, whose positions or elevations (or both) have been or will be determined. (JP 2-03) 3. Physical or psychological pressures exerted with the intent to assure that an agent or group will respond as directed. (JP 3-0) 4. An indicator governing the distribution and use of documents, information, or material. Such indicators are the subject of intelligence community agreement and are specifically defined in appropriate regulations. (JP 2-01) See FM 3-07. (Army) 1. The regulation of forces and warfighting functions to accomplish the mission in accordance with the commander's intent. (ADP 6-0) 2. A tactical mission task that requires the commander to maintain physical influence over a specified area to prevent its use by an enemy or to create conditions necessary for successful friendly operations. (FM 3-90-1) 3. An action taken to eliminate a hazard or reduce its risk. (FM 5-19)

**controlled supply rate** – The rate of ammunition consumption that can be supported, considering availability, facilities, and transportation. It is expressed in rounds per unit, individual, or vehicle per day. The Army Service component commander announces the controlled supply rate for each item of ammunition, and, in turn, the commander of each subordinate tactical unit announces a controlled supply rate to his commanders at the next lower levels. A unit may not draw ammunition in excess of its controlled supply rate without authority from its next higher headquarters. Also called CSR. (FM 4-30.1)

**control measure** – A means of regulating forces or warfighting functions. (ADRP 6-0)

**conventional forces** – (DOD) Those forces capable of conducting operations using nonnuclear weapons; 2. Those forces other than designated special operations forces. (JP 3-05) See ADRP 3-05.

**coordinated fire line** – (DOD) A line beyond which conventional and indirect surface fire support means may fire at any time within the boundaries of the establishing headquarters without additional coordination. The purpose of the coordinated fire line is to expedite the surface-to-surface attack of targets beyond the coordinated fire line without coordination with the ground commander in whose area the targets are located. Also called CFL. (JP 3-09) See FM 3-09 and FM 3-90-1.

**cordon and search** – A technique of conducting a movement to contact that involve isolating a target area and searching suspect locations within that target area to capture or destroy possible enemy forces and contraband. (FM 3-90-1)

- corps** – The Army’s largest tactical unit and the instrument by which joint force commanders conduct operational-level maneuver. (ADRP 1-02)
- counterattack** – Attack by part or all of a defending force against an enemy attacking force, for such specific purposes as regaining ground lost, or cutting off or destroying enemy advance units, and with the general objective of denying to the enemy the attainment of the enemy’s purpose in attacking. In sustained defensive operations, it is undertaken to restore the battle position and is directed at limited objectives. (ADRP 1-02)
- counterfire** – (DOD) Fire intended to destroy or neutralize enemy weapons. Includes counterbattery and countermortar fire. (JP 3-09) See ADRP 3-09, FM 3-90-1 and ATP 3-09.24.
- counterinsurgency** – (DOD) Comprehensive civilian and military efforts taken to defeat an insurgency and to address any core grievances. (JP 3-24) See ADP 3-05, ADRP 3-05 and ADRP 3-07.
- counterintelligence** – (DOD) Information gathered and activities conducted to identify, deceive, exploit, disrupt, or protect against espionage, other intelligence activities, sabotage, or assassinations conducted for or on behalf of foreign powers, organizations or persons or their agents, or international terrorist organizations or activities. Also called CI. (JP 1-02) See FM 2-22.2 and ATP 3-05.20. (Army) Counters or neutralizes intelligence collection efforts through collection, counterintelligence investigations, operations analysis, production, and technical services and support. Counterintelligence includes all actions taken to detect, identify, track, exploit, and neutralize the multidiscipline intelligence activities of friends, competitors, opponents, adversaries, and enemies; is the key intelligence community contributor to protect U.S. interests and equities; assists in identifying essential elements of friendly information, identifying vulnerabilities to threat collection, and actions taken to counter collection and operations against U.S. forces. (FM 2-22.2)
- counterintelligence insider threat** – (DOD) A person, known or suspect, who uses their authorized access to Department of Defense facilities, systems, equipment, information or infrastructure to damage, disrupt operations, commit espionage on behalf of a foreign intelligence entity or support international terrorist organizations. (JP 1-02) See ADRP 2-0.
- countermobility operations** – (Army) Those combined arms activities that use or enhance the effects of natural and man-made obstacles to deny an adversary freedom of movement and maneuver. (FM 3-34) See also **destroy; disrupt**.
- counterpreparation fire** – Intensive prearranged fire delivered when the imminence of the enemy attack is discovered. It is designed to breakup enemy formations; delay movement of reinforcements to reserve; disorganize the enemy’s system of command, communications, and observation; decrease the effectiveness of artillery preparation; and impair the enemy’s offensive spirit. (FM 3-09)
- counterproliferation** – (DOD) Those actions taken to defeat the threat and/or use of weapons of mass destruction against the United States, our forces, allies, and partners. Also called CP. (JP 3-40) See ADRP 3-05.
- counterreconnaissance** – A tactical mission task that encompasses all measures taken by a commander to counter enemy reconnaissance and surveillance efforts. Counterreconnaissance is not a distinct mission, but a component of all forms of security operations. (FM 3-90-1) See also **tactical mission task**.
- counterterrorism** – (DOD) Actions taken directly against terrorist networks and indirectly to influence and render global and regional environments inhospitable to terrorist networks. (JP 3-05) See ADP 3-05 and ADRP 3-05.
- country team**– (DOD) The senior, in-country U.S. coordinating and supervising body, headed by the chief of the U.S. diplomatic mission, and composed of the senior member of each represented U.S. department or agency, as desired by the chief of the U.S. diplomatic mission. (JP 3-07.4) See ATP 3-57.20, FM 3-07, and FM 3-57.
- course of action** – (DOD) A scheme developed to accomplish a mission. (JP 5-0) See chapter 10 of this publication.

**cover** – 1. Protection from the effects of fires. (ADRP 1-02) 2. A security task to protect the main body by fighting to gain time while also observing and reporting information and preventing enemy ground observation of and direct fire against the main body. (ADRP 3-90) See also **covering force; security operations**.

**covered approach** – 1. Any route that offers protection against enemy fire. 2. An approach made under the protection furnished by other forces or by natural cover. (FM 3-21.10) See also **concealment; cover**.

**covering force** – (Army) A self-contained force capable of operating independently of the main body, unlike a screen or guard force to conduct the cover task. (FM 3-90-2)

**covering force area** – The area forward of the forward edge of the battle area out to the forward positions initially assigned to the covering forces. It is here that the covering forces execute assigned tasks. (FM 3-90-2) See also **covering force; forward edge of the battle area**.

**covert crossing** – The crossing of an inland water obstacle or other gap that is planned and intended to be executed without detection by an adversary. (ATTP 3-90.4)

**covert operation** – An operation that is so planned and executed as to conceal the identity of or permit plausible denial by the sponsor. (ADRP 1-02)

**crew** – Consists of all personnel operating a particular system. (ADRP 3-90)

**crisis action planning** – (DOD) The Adaptive Planning and Execution system process involving the time-sensitive development of joint operation plans and operation orders for the deployment, employment, and sustainment of assigned and allocated forces and resources in response to an imminent crisis. Also called CAP. (JP 5-0) See ATP 3-27.5.

**critical asset list** – (DOD) A prioritized list of assets, normally identified by phase of the operation and approved by the joint force commander, that should be defended against air and missile threats. (JP 3-01) See ADRP 3-09 and ADRP 3-37.

**critical asset security** – The protection and security of personnel and physical assets or information that is analyzed and deemed essential to the operation and success of the mission and to resources required for protection. (ADRP 3-37)

**critical capability** – (DOD) A means that is considered a crucial enabler for a center of gravity to function as such and is essential to the accomplishment of the specified or assumed objective(s). (JP 5-0) See ATP 3-05.20.

**critical event** – An event that directly influences mission accomplishment. (ATTP 5-0.1)

**critical friendly zone** – An area usually a friendly unit or location, which the maneuver commander designates as critical to the protection of an asset whose loss would jeopardize the mission (ADRP 1-02)

**critical requirement** – (DOD) An essential condition, resource, and means for a critical capability to be fully operational. (JP 5-0) See ATP 3-05.20.

**critical vulnerability** – (DOD) An aspect of a critical requirement which is deficient or vulnerable to direct or indirect attack that will create decisive or significant effects. (JP 5-0) See ATP 3-05.20.

**cueing** – The integration of one or more types of reconnaissance or surveillance systems to provide information that directs follow-on collection of more detailed information by another system. (FM 3-90-2)

**culminating point** – (Army) That point in time and space at which a force no longer possesses the capability to continue its current form of operations. (ADRP 3-0)

**cyber electromagnetic activities** – Activities leveraged to seize, retain, and exploit and advantage over adversaries and enemies in both cyberspace and the electromagnetic spectrum, while simultaneously denying and degrading adversary and enemy use of the same, and protecting the mission command system. (ADRP 3-0)



## —D—

- data** – (Army) Unprocessed signals communicated between any nodes in an information system, or sensing from the environment detected by a collector of any kind (human, mechanical, or electronic). (ADRP 6-0)
- danger close** – (DOD) In close air support, artillery, mortar, and naval gunfire support fires, it is the term included in the method of engagement segment of a call for fire which indicates that friendly forces are within close proximity of the target. The close proximity distance is determined by the weapon and munition fired. (JP 3-09.3) See ATP 3-06.1.
- datum (geodetic)** – (DOD) 1. A reference surface consisting of five quantities: the latitude and longitude of an initial point, the azimuth of a line from that point, and the parameters of the reference ellipsoid. 2. The mathematical model of the earth used to calculate the coordinates on any map. Different nations use different datum for printing coordinates on their maps. (JP 2-03) See ATP 3-06.1 and ATP 3-50.3.
- debriefing** – The systematic questioning of individuals to procure information to answer specific collection requirements by direct and indirect questioning techniques. (FM 2-22.3)
- decision point** – (DOD) A point in space and time when the commander or staff anticipates making a key decision concerning a specific course of action. (JP 5-0) See ADRP 5-0.
- decision support matrix** – A written record of a war-gamed course of action that describes decision points and associated actions at those decision points. Also called DSM. (ADRP 5-0) See also **branch; decision point; decision support template; sequel; wargaming**.
- decision support template** – (DOD) A combined intelligence and operations graphic based on the results of wargaming. The decision support template depicts decision points, timelines associated with movement of forces and the flow of the operation, and other key items of information required to execute a specific friendly course of action. (JP 2-01.3) See ADRP 5-0.
- decisive action** – (Army) The continuous, simultaneous combinations of offensive, defensive, and stability or defense support of civil authorities tasks. (ADRP 3-0)
- decisive engagement** – An engagement in which a unit is considered fully committed and cannot maneuver or extricate itself. In the absence of outside assistance, the action must be fought to a conclusion and either won or lost with the forces at hand. (ADRP 3-90)
- decisive operation** – The operation that directly accomplishes the mission. (ADRP 3-0) See also **battle; engagement; major operation; shaping operation**.
- decisive point** – (DOD) A geographic place, specific key event, critical factor, or function that, when acted upon, allows commanders to gain a marked advantage over an adversary or contribute materially to achieving success. (JP 5-0) See ADRP 3-0, ADRP 3-07, and ADRP 5-0.
- decisive terrain** – Decisive terrain, when, present, is key terrain whose seizure and retention is mandatory for successful mission accomplishment. (FM 3-90-1) See also **key terrain**.
- decontamination** – (DOD) The process of making any person, object, or area safe by absorbing, destroying, neutralizing, making harmless, or removing chemical or biological agents, or by removing radioactive material clinging to or around it. (JP 3-11) See ATP 4-02.84.
- deep area** – In contiguous areas of operation, an area forward of the close area that a commander uses to shape enemy forces before they are encountered or engaged in the close area. (ADRP 3-0)
- defeat** – A tactical mission task that occurs when an enemy force has temporarily or permanently lost the physical means or the will to fight. The defeated force's commander is unwilling or unable to pursue his adopted course of action, thereby yielding to the friendly commander's will, and can no longer interfere to a significant degree with the actions of friendly forces. Defeat can result from the use of force or the threat of its use. (FM 3-90-1) See also **decisive point; tactical mission task**.
- defeat in detail** – Concentrating overwhelming combat power against separate parts of a force rather than defeating the entire force at once. (ADRP 3-90) See also **combat power**.

**defeat mechanism** – The method through which friendly forces accomplish their mission against enemy opposition. (ADRP 3-0)

**defended asset list** – (DOD) A listing of those assets from the critical asset list prioritized by the joint force commander to be defended with the resources available. (JP 3-01) See ADRP 3-09 and ADRP 3-37.

**defense support of civil authorities** – (DOD) Support provided by U.S. Federal military forces, Department of Defense civilians, Department of Defense contract personnel, Department of Defense component assets, and National Guard forces (when the Secretary of Defense, in coordination with the governors of the affected States, elects and requests to use those forces in Title 32, United States Code, status) in response to requests for assistance from civil authorities for domestic emergencies, law enforcement support, and other domestic activities, or from qualifying entities for special events. Also called DSCA. Also known as civil support. (DODD 3025.18) See ADP 3-28, ADRP 3-28, ATP 3-28.1, ATTP 2-01, FM 1-04, and FM 3-57.

**defensive fires** – Fires that protect friendly forces, population centers, and critical infrastructure. (FM 3-09)

**defensive task** – A task conducted to defeat an enemy attack, gain time, economize forces, and develop conditions favorable for offensive or stability tasks. (ADRP 3-0)

**defile** – A special movement circulation control measure conducted to keep traffic moving smoothly through a narrow passageway. (FM 3-39)

**definitive identification** – The employment of multiple state-of-the-art, independent, established protocols and technologies by scientific experts in a nationally recognized laboratory to determine the unambiguous identity of a chemical, biological, radiological, and/or nuclear hazard with the highest level of confidence and degree of certainty necessary to support strategic-level decisions. (ATP 3-11.37)

**delay line** – A phase line where the date and time before which the enemy is not allowed to cross the phase line is depicted as part of the graphic control measure. (FM 3-90-1) See also **control measure; phase line**.

**delaying operation** – (DOD) An operation in which a force under pressure trades space for time by slowing down the enemy's momentum and inflicting maximum damage on the enemy without, in principle, becoming decisively engaged. (JP 3-04) See ADP 3-90, ADRP 3-90, and FM 3-90-1.

**deliberate crossing** – The crossing of an inland water obstacle or other gap that requires extensive planning and detailed preparations. (ATTP 3-90.4)

**deliberate operation** – An operation in which the tactical situation allows the development and coordination of detailed plans, including multiple branches and sequels. (ADRP 3-90)

**demobilization** – (DOD) The process of transitioning a conflict or wartime military establishment and defense-based civilian economy to a peacetime configuration while maintaining national security and economic vitality. (JP 4-05) See ADRP 3-07 and FM 3-07.

**demonstration** – (DOD) 2. In military deception, a show of force in an area where a decision is not sought that is made to deceive an adversary. It is similar to a feint but no actual contact with the adversary is intended. (JP 3-13.4) See FM 3-90-1.

**denial operations** – Actions to hinder or deny the enemy the use of space, personnel, supplies, or facilities. (FM 3-90-1)

**denied area** – (DOD) An Area under enemy or unfriendly control in which friendly forces cannot expect to operate successfully within existing operational constraints and force capability. (JP 3-05) See ADRP 3-05. (Army) An area that is operationally unsuitable for conventional forces due to political, tactical, environmental, or geographical reasons. It is a primary area for special operations forces. (FM 3-05)

**destroy** – A tactical mission task that physically renders an enemy force combat-ineffective until it is reconstituted. Alternatively, to destroy a combat system is to damage it so badly that it cannot perform any function or be restored to a usable condition without being entirely rebuilt. (FM 3-90-1) See also **reconstitution; tactical mission task**.

**destruction** – 1. In the context of the computed effects of field artillery fires, destruction renders a target out of action permanently or ineffective for a long period of time, producing 30-percent casualties or materiel damage. 2. A type of adjustment for destroying a given target. (FM 3-09)

**detachment** – A detachment is a tactical element organized on either a temporary or permanent basis for special duties. (ADRP 3-90) See also **assign; attach; command relationships; operational control**.

**detachment left in contact** – An element left in contact as part of the previously designated (usually rear) security force while the main body conducts its withdrawal. Also called DLIC. (FM 3-90-1) See also **breakout; retrograde**.

**detainee** – (DOD) A term used to refer to any person captured or otherwise detained by an armed force. (JP 3-63) See FM 1-04.

**detection** – (DOD) 2. In surveillance, the determination and transmission by a surveillance system that an event has occurred. (JP 3-11) See ATP 3-55.6.

**diamond formation** – A diamond formation is a variation of the box combat formation with one maneuver unit leading, maneuver units positioned on each flank, and the remaining maneuver unit to the rear. (ADRP 3-90) See also **box formation; flank**.

**direct action** – (DOD) Short-duration strikes and other small-scale offensive actions conducted as a special operation in hostile, denied, or politically sensitive environments and which employ specialized military capabilities to seize, destroy, capture, exploit, recover, or damage designated targets. (JP 3-05) See ADP 3-05 and ADRP 3-05.

**direct approach** – The manner in which a commander attacks the enemy's center of gravity or principal strength by applying combat power directly against it. (ADRP 3-90)

**direct fire** – (DOD) Fire delivered on a target using the target itself as a point of aim for either the weapon or the director. (JP 3-09.3) See ATP 3-06.1.

**direct haul** – Single transport mission completed by the same vehicle(s). (ATP 4-11)

**direct pressure force** – A force employed in a pursuit operation that orients on the enemy main body to prevent enemy disengagement or defensive reconstitution prior to envelopment by the encircling force. It normally conducts a series of attacks to slow the enemy's retirement by forcing him to stand and fight. (FM 3-90-1) See also **disengage; encircling force; envelopment; reconstitution**.

**direct support** – (DOD) A mission requiring a force to support another specific force and authorizing it to answer directly to the supported force's request for assistance. Also called DS. (JP 3-09.3) See ATTP 2-01. (Army) A support relationship requiring a force to support another specific force and authorizing it to answer directly to the supported force's request for assistance. (ADRP 5-0)

**direction of attack** – A specific direction or assigned route a force uses and does not deviate from when attacking. (ADRP 3-90) See also **axis of advance**.

**directive authority for logistics** – (DOD) Combatant command authority to issue directives to subordinate commanders, including peacetime measures, necessary to ensure effective execution of approved operation plans. Essential measures include the optimized use or reallocation of available resources and prevention of elimination of redundant facilities and/or overlapping functions among the Service component commands. Also called DAFL. (JP 1) See ADRP 4-0.

**disarmament** – (Army) The collection, documentation, control, and disposal of small arms, ammunition, explosives, and light and heavy weapons of former combatants, belligerents, and the local populace. (FM 3-07)

**disengage** – A tactical mission task where a commander has his unit break contact with the enemy to allow the conduct of another mission or to avoid decisive engagement. (FM 3-90-1) See also **decisive engagement; tactical mission task**.

**disengagement line** – A phase line located on identifiable terrain that, when crossed by the enemy, signals to defending elements that it is time to displace to their next position. (ADRP 3-90) See also **phase line**.

**dislocated civilian** – (DOD) A broad term primarily used by the Department of Defense that includes displaced person, and evacuee, an internally displaced person, a migrant, a refugee, or a stateless person. Also called DC. (JP 3-29) See FM 3-57.

**dismounted march** – Movement of troops and equipment mainly by foot, with limited support by vehicles. Also called foot march. (FM 3-90-2)

**displaced person** – (DOD) A broad term used to refer to internally and externally displaced persons collectively. (JP 3-29) See FM 3-57.

**disrupt** – 1. A tactical mission task in which a commander integrates direct and indirect fires, terrain, and obstacles to upset an enemy's formation or tempo, interrupt his timetable, or cause enemy forces to commit prematurely or attack in piecemeal fashion. (FM 3-90-1) 2. An obstacle effect that focuses fire planning and obstacle effort to cause the enemy to break up his formation and tempo, interrupt his timetable, commit breaching assets prematurely, and attack in a piecemeal effort. (FM 90-7)

**distribution management** – The function of synchronizing and coordinating a complex of networks (physical, communications, information, and resources) and the sustainment functions (logistics, personnel services, and health service support) to achieve responsive support to operational requirements. (ADRP 1-02)

**division** – An Army echelon of command above brigade and below corps. It is a tactical headquarters which employs a combination of brigade combat teams, multifunctional brigades, and functional brigades in land operations. (ADRP 3-90)

**doctrine** – (DOD) Fundamental principles by which the military forces or elements thereof guide their actions in support of national objectives. It is authoritative but requires judgment in application, (JP 1-02) See ADP 1-02.

**double envelopment** – This results from simultaneous maneuvering around both flanks of a designated enemy force. (FM 3-90-1)

**drop zone** – (DOD) A specific area upon which airborne troops, equipment, or supplies are airdropped. Also called DZ. (JP 3-17) See ATP 3-06.1.

**dynamic target** – Any target that is identified too late or not selected for action during the deliberate targeting process. (ATP 3-60.1)

**dynamic targeting** – (DOD) Targeting that prosecutes targets identified too late, or not selected for action in time to be included in deliberate targeting. (JP 3-60) See ATP 3-60.1.

—E—

**early-entry command post** – A lead element of a headquarters designed to control operations until the remaining portions of the headquarters are deployed and operational. (ATTP 5-0.1) See also **command post; main command post; tactical command post**.

**echelon** – Separate level of command. (ADRP 1-02)

**echelon formation** – A unit formation with subordinate elements arranged on an angle to the left or to the right of the direction of attack (echelon left, echelon right). This formation provides for firepower forward and to the flank of the direction of the echelon. It facilitates control in open areas. It provides minimal security to the opposite flank of the direction of the echeloning. (FM 3-90-1) See also **box formation**.

**echelons above corps** – Army headquarters and organizations that provide the interface between the theater commander (joint or multinational) and the corps for operational matters. Also called EAC. (ADRP 1-02)

**economy** – Providing sustainment resources in an efficient manner to enable a commander to employ all assets to achieve the greatest effect possible. (ADP 4-0)

**effect** – (DOD) 1. The physical or behavioral state of a system that results from an action, a set of actions, or another effect. 2. The result, outcome, or consequence of an action. 3. A change to a condition, behavior, or degree of freedom. (JP 3-0) See ATP 3-09.24 and FM 3-57.

**electronic intelligence** – (DOD) Technical and geolocation intelligence derived from foreign noncommunications electromagnetic radiations emanating from other than nuclear detonations or radioactive sources. Also called ELINT. (JP 3-13.1) See ATP 3-05.20.

- emergency management** – A subset of incident management and concerns the coordination and integration of activities that are necessary to build, sustain, and improve the capability to prepare for, protect against, respond, recover from, or mitigate threatened or actual natural disaster, acts of terrorism, or other manmade disasters. (FM 3-11)
- emergency operations center** – (DOD) A temporary or permanent facility where the coordination of information and resources to support domestic incident management activities normally takes place. Also called EOC. (JP 3-41) See ADRP 3-28.
- emergency support functions** – (DOD) A grouping of government and certain private-sector capabilities into an organizational structure to provide the support, resources, program implementation, and services that are most likely to be needed to save lives, protect property and the environment, restore essential services and critical infrastructure, and help victims and communities return to normal, when feasible, following domestic incidents. Also called ESFs. (JP 3-28) See ATP 3-28.1.
- emerging target** – Detection that meets sufficient criteria to be developed as a potential target using dynamic targeting. The criticality and time sensitive of an emerging target, and its probability of being a potential target, is initially undetermined. (ATP 3-60.1)
- encirclement operations** – Operations where one force loses its freedom of maneuver because an opposing force is able to isolate it by controlling all ground lines of communications and reinforcement. (ADRP 3-90)
- encircling force** – In pursuit operations, the force which maneuvers to the rear or flank of the enemy to block his escape so that the enemy can be destroyed between the direct pressure force and encircling force. This force advances or flies along routes parallel to the enemy's line of retreat. If the encircling force cannot outdistance the enemy to cut the enemy off, the encircling force may also attack the flank of a retreating enemy. (FM 3-90-1) See also **block; destroy; direct pressure force; envelopment**.
- end state** – (DOD) The set of required conditions that defines achievement of the commander's objectives. (JP 3-0) See FM 3-07.
- enemy** – A party identified as hostile against which the use of force is authorized. (ADRP 3-0)
- enemy combatant** – (DOD) In general, a person engaged in hostilities against the United States or its coalition partners during an armed conflict. Also called EC. (DODD 2310.01E) See FM 1-04.
- engagement** – (DOD) 1. In air defense, and attack with guns or air-to-air missiles by an interceptor aircraft, or the launch of an air defense missile by air defense artillery and the missile's subsequent travel to intercept. (JP 3-01) See FM 3-07. 2. A tactical conflict, usually between opposing, lower echelon maneuver forces. (JP 3-0) See ADP 3-90, ADRP 3-90, ATP 3-20.15, and FM 3-07.
- engagement area** – An area where the commander intends to contain and destroy an enemy force with the massed effects of all available weapons and supporting systems. Also called EA. (FM 3-90-1) See also **contain; destroy**.
- engagement criteria** – Protocols that specify those circumstances for initiating engagement with an enemy force. (FM 3-90-1) See also **decision point; engagement; engagement area**.
- engagement priority** – Specifies the order in which the unit engages enemy systems or functions. (FM 3-90-1)
- engineer regulating point** – Checkpoint to ensure that vehicles do not exceed the capacity of the crossing means and to give drivers final instructions on site-specific procedures and information, such as speed and vehicle interval. Also called ERP. (ATTP 3-90.4)
- envelopment** – A form of maneuver in which an attacking force seeks to avoid the principal enemy defenses by seizing objectives behind those defenses that allow the targeted enemy force to be destroyed in their current positions. (FM 3-90-1)
- esoteric communications** – Public statements whose surface meaning (manifest content) does not reveal the real purpose, meaning, or significance (latent content) of the author. (ATP 2-22.9)
- essential element of friendly information** – (Army) A critical aspect of a friendly operation that, if known by the enemy, would subsequently compromise, lead to failure, or limit success of the operation and therefore

should be protected from enemy detection. (ADRP 5-0) See also **commander's critical information requirement**.

**essential personnel services** – Essential personnel services include customer service, awards and decorations, evaluation reports, promotions and reductions, transfers and discharges, officer procurement, leaves and passes, military pay, personnel action request, line of duty investigations, AR 15-6 investigations, suspension of favorable actions and bars to reenlistment, citizenship and naturalization, congressional inquiries, and common access card and identification tags. (ATP 1-0.2)

**essential task** – (Army) A specified or implied task that must be executed to accomplish the mission. (ATTP 5-0.1) See also **implied task; specified task**.

**evaluating** – Using criteria to judge progress toward desired conditions and determining why the current degree of progress exists. (ADRP 5-0)

**evasion plan of action** – (DOD) A course of action, developed prior to executing a combat mission, that is intended to improve a potential isolated person's chances of successful evasion and recovery by providing the recovery forces with an addition source of information that can increase the predictability of the evader's action and movement. Also called EPA. (JP 3-50) See ATP 3-50.3.

**event template** – (Army) A model against which threat activity can be recorded and compared. It represents a sequential projection of events that relate to space and time on the battlefield and indicate the enemy's ability to adopt a particular course of action. The event template is a guide for collection and reconnaissance and surveillance planning. (FM 2-01.3) See also **area of interest; decision support template; named area of interest; situation template**.

**execution** – Putting a plan into action by applying combat power to accomplish the mission. (ADP 5-0) See also **adjustment decision; combat power; execution decision; situational understanding**.

**execution matrix** – A visual and sequential representation of the critical tasks and responsible organizations by time. (ADRP 5-0)

**exfiltrate** – A tactical mission task where a commander removes Soldiers or units from areas under enemy control by stealth, deception, surprise, or clandestine means. (FM 3-90-1)

**exploitation** – (Army) An offensive task that usually follows a successful attack and is designed to disorganize the enemy in depth. (ADRP 3-90) See also **attack; offensive operations**.

**exterior lines** – Lines on which a force operates when its operations converge on the enemy. (ADRP 3-0)

—F—

**farside objective** – A defined location on the far side of an obstacle that an assaulting force seizes to eliminate enemy direct fires and observed indirect fires onto a reduction area or a crossing site to prevent the enemy from interfering with the reduction of the obstacle and allow follow-on forces to move securely through the created lanes. It can be oriented on the terrain or on an enemy force. (ATTP 3-90.4)

**federal service** – (DOD) A term applied to National Guard members and units when called to active duty to serve the United States Government under Article I, Section 8 and Article II, Section 2 of the Constitution and the Title 10, United States Code, Sections 12401 to 12408. (JP 4-05) See ADRP 3-28.

**feint** – (DOD) In military deception, an offensive action involving contact with the adversary conducted for the purpose of deceiving the adversary as to the location and/or time of the actual main offensive action. (JP 3-13.4) See FM 3-90-1.

**field artillery** – The equipment, supplies, ammunition, and personnel involved in the use of indirect fire cannon, rocket, or surface-to-surface missile launchers. (ADRP 3-09)

**field confirmatory identification** – The employment of technologies with increased specificity and sensitivity by technical forces in a field environment to identify chemical, biological, radiological, and/or nuclear hazard with a moderate level of confidence and degree of certainty necessary to support follow-on tactical decisions. (ATP 3-11.37)

**field of fire** – The area that a weapon or group of weapons may cover effectively from a given position. (FM 3-90-1)

**field services** – Includes aerial delivery, clothing and light-textile repair, food service, shower and laundry, mortuary affairs, and water purification. These services enhance unit effectiveness and mission success by providing for Soldier basic needs. (ADRP 4-0)

**final coordination line** – A phase line close to the enemy position used to coordinate the lifting or shifting of supporting fires with the final deployment of maneuver elements. Also called FCL. (ADRP 3-90) See also **assault; assault echelon; phase line**.

**final protective fire** – (DOD, NATO) An immediately available prearranged barrier of fire designed to impede enemy movement across defensive lines or areas. (JP 1-02) See ADRP 3-90 and FM 3-09-1.

**final protective line** – A line of fire selected where an enemy assault is to be checked by interlocking fire from all available weapons and obstacles. Also called FPL. (ADRP 1-02) See also **field of fire; final protective fire**.

**finance operations** – The execution of the joint financial management mission to provide financial advice and guidance, support the procurement process, provide pay support, and provide banking and disbursing support. (FM 1-06)

**financial management** – The sustainment of U.S. Army, joint, interagency, interdepartmental, and multinational operations through the execution of two mutually supporting core functions, resource management and finance operations. These two functions are comprised of the following core competencies: fund the force, banking and disbursing support, pay support, accounting support and cost management, financial management planning and operations, and management internal controls. (FM 1-06)

**fire and movement** – The concept of applying fires from all sources to suppress, neutralize, or destroy the enemy, and the tactical movement of combat forces in relation to the enemy (as components of maneuver, applicable at all echelons). At the squad level, it entails a team placing suppressive fire on the enemy as another team moves against or around the enemy. (FM 3-90.6) See also **bounding overwatch; destroy; maneuver; neutralize; support by fire; suppress**.

**fire plan** – A tactical plan for using the weapons of a unit or formation so that their fires will be coordinated. (ATP 3-09.24)

**fire strike** – The massed, synchronized, and nearly simultaneous delivery of primarily terminally guided indirect fire and area munitions. (FM 3-90-2)

**fire superiority** – That degree of dominance in the fires of one force over another that permits that force to conduct maneuver at a given time and place without prohibitive interference by the enemy. (FM 3-90-1) See also **maneuver**.

**fire support** – (DOD) The fires that directly support land, maritime, amphibious, and special operations forces to engage enemy forces, combat formations, and facilities in pursuit of tactical and operational objectives. (JP 3-09) See ADP 3-09, ADRP 3-09, ATP 3-06.1 and ATP 3-09.24.

**fire support coordination** – (DOD) The planning and executing of fire so that targets are adequately covered by a suitable weapon or group of weapons. (JP 3-09) See ADRP 3-09 and ATP 3-09.24.

**fire support coordination line** – (DOD) fire support coordination measure that is established and adjusted by appropriate land or amphibious force commanders within their boundaries in consultation with superior, subordinate, supporting, and affected commanders. Fire support coordination lines facilitate the expeditious attack of surface targets of opportunity beyond the coordinating measure. A fire support coordination line does not divide an area of operations by defining a boundary between close and deep operations or a zone for close air support. The fire support coordination line applies to all fires of air, land, and sea-based weapon systems using any type of ammunition. Forces attacking targets beyond a fire support coordination line must inform all affected commanders in sufficient time to allow necessary reaction to avoid fratricide. Supporting elements attacking targets beyond the fire support coordination line must ensure that the attack will not produce adverse effects on, or to the rear of, the line. Short of a fire support coordination line, all air-to-ground and surface-to-surface attack operations are controlled by the appropriate land or amphibious

force commander. The fire support coordination line should follow well-defined terrain features. Coordination of attacks beyond the fire support coordination line is especially critical to commanders of air, land, and special operations forces. In exceptional circumstances, the inability to conduct this coordination will not preclude the attack of targets beyond the fire support coordination line. However, failure to do so may increase the risk of fratricide and could waste limited resources. Also called FSCL. (JP 3-09) See FM 3-09-1.

**fire support coordination measure** – (DOD) A measure employed by commanders to facilitate the rapid engagement of targets and simultaneously provide safeguards for friendly forces. Also called FSCM. (JP 3-0) See ATP 3-09.24.

**fire support coordination** – (DOD) The planning and executing of fire so that targets are adequately covered by a suitable weapon or group of weapons. (JP 3-09) See ADP 3-09 and ADRP 3-09.

**fire support coordinator** – The brigade combat team's organic field artillery battalion commander; if a fires brigade is designated as the division force field artillery headquarters, the fires brigade commander is the division's fire support coordinator and is assisted by the chief of fires who then serves as the deputy fire support coordinator during the period the force field artillery headquarters is in effect. (ADRP 3-09) See also **fire support**.

**fire support officer** – (Army) The field artillery officer from the operational to tactical level responsible for advising the supported commander or assisting the senior fires officer of the organization on fires functions and fire support. (ADRP 3-09)

**fire support team** – A field artillery team organic to each maneuver battalion and selected units to plan and coordinate all available company supporting fires, including mortars, field artillery, naval surface fire support, and close air support integration. (ADRP 3-09)

**fire team** – A small military unit. (ADRP 3-90)

**fires** – (DOD) The use of weapons systems to create a specific lethal or nonlethal effect on a target. (JP 3-0) See ADP 3-09 and ATP 3-09.24

**fires warfighting function** – The related tasks and systems that provide collective and coordinated use of Army indirect fires, air and missile defense, and joint fires through the targeting process. (ADRP 3-0)

**fix** – A tactical mission task where a commander prevents the enemy from moving any part of his force from a specific location for a specific period. Fix is also an obstacle effect that focuses fire planning and obstacle effort to slow an attacker's movement within a specified area, normally an engagement area. (FM 3-90-1) See also **block; contain; disrupt; support by fire; tactical mission task; turn**.

**flank** – The right or left limit of a unit. (ADRP 3-90)

**flank attack** – A form of offensive maneuver directed at the flank of an enemy. (FM 3-90-1)

**flanking position** – A geographical location on the flank of the force from which effective fires can be placed on that flank. (ADRP 3-90)

**follow and assume** – A tactical mission task in which a second committed force follows a force conducting an offensive task and is prepared to continue the mission if the lead force is fixed, attrited, or unable to continue. (FM 3-90-1) See also **attack; fix; follow and support; offensive operations; tactical mission task**.

**follow and support** – A tactical mission task in which a committed force follows and supports a lead force conducting an offensive task. (FM 3-90-1) See also **direct pressure force; encircling force; exploitation; follow and assume; offensive operations; tactical mission task**.

**follow-on echelon** – Those additional forces moved into the objective area after the assault echelon. (ADRP 1-02) See also **air assault operation; assault echelon**.

**force field artillery headquarters** – If designated by the supported commander, is normally the senior field artillery headquarters organic, assigned, attached, or placed under the operational control of that command. The supported commander specifies the commensurate responsibilities of the force field artillery headquarters and the duration of those responsibilities. (ADRP 3-09)



- force health protection** – (DOD) 1. Measures to promote, improve, or conserve the behavioral and physical well-being of Service members to enable a healthy and fit force, prevent injury and illness, and protect the force from health hazards. Also called FHP. (JP 4-02) See ATP 4-02.84 and FM 4-02. (Army) 2. Encompasses measures to promote, improve, conserve or restore the mental or physical well-being of Soldiers. These measures enable a healthy and fit force, prevent injury and illness, and protect the force from health hazards. These measures also include the prevention aspects of a number of Army Medical Department functions (preventive medicine, including medical surveillance and occupational and environmental health surveillance; veterinary services, including the food inspection and animal care missions, and the prevention of zoonotic disease transmissible to man; combat and operational stress control; dental services (preventive dentistry); and laboratory services [area medical laboratory support]). (FM 4-02)
- force projection** – (DOD) The ability to project the military instrument of national power from the United States or another theater, in response to requirements for military operations. (JP 3-0) See ADP 4-0.
- force protection** – (DOD) Preventive measures taken to mitigate hostile actions against Department of Defense personnel (to include family members), resources, facilities, and critical information. (JP 3-0) See ADRP 3-37.
- force tailoring** – The process of determining the right mix of forces and the sequence of their deployment in support of a joint force commander. (ADRP 3-0)
- ford** – A shallow part of a body of water or wet gap that can be crossed without bridging, boats, ferries, or rafts. It is a location in a water barrier where the physical characteristics of current, bottom, and approaches permit the passage of personnel, vehicles, and other equipment where the wheels or tracks remain in contact with the bottom at all times. (ATTP 3-90.4) See also **gap**.
- foreign disaster relief** – (DOD) Prompt aid that can be used to alleviate the suffering of foreign disaster victims. Normally, it includes humanitarian services and transportation; provision of food, clothing, medicine, beds, and bedding; temporary shelter and housing; the furnishing of medical materiel and medical and technical personnel; and making repairs to essential services. (JP 3-29) See ATP 3-57.20.
- foreign humanitarian assistance** – (DOD) Department of Defense activities, normally in support of the United States Agency for International Development of Department of State, conducted outside the United States, its territories, and possessions to relieve or reduce human suffering, disease, hunger, or privation. Also called FHA. (JP 3-29) See ATP 1-06.2, ATP 3-07.5, ATP 3-57.20, and FM 3-57.
- foreign instrumentation signals intelligence** – (DOD) A subcategory of signals intelligence, consisting of technical information and intelligence derived from the intercept of foreign electromagnetic emissions associated with the testing and operational deployment of non-US aerospace, surface, and subsurface systems. Foreign instrumentation signals include but are not limited to telemetry, beaconry, electronic interrogators, and video data links. Also called FISINT. (JP 2-01) See ATP 3-05.20.
- foreign internal defense** – (DOD) Participation by civilian and military agencies of a government in any of the action programs taken by another government or other designated organization to free and protect its society from subversion, lawlessness, insurgency, terrorism, and other threats to its security. Also called FID. (JP 3-22) See ADP 3-05, ADRP 3-05, ADRP 3-07, ATP 3-57.20, and FM 3-57.
- foreign security forces** – Forces, including, but not limited to military, paramilitary, police, and intelligence forces; border police, coast guard, and customs officials; and prison guards and correctional personnel, that provide security for a host nation and its relevant population or support a regional security organization's mission. (FM 3-22)
- forms of maneuver** – Distinct tactical combinations of fire and movement with a unique set of doctrinal characteristics that differ primarily in the relationship between the maneuvering force and the enemy. (ADRP 3-90)
- forward boundary** – A boundary of an echelon that is primarily designated to divide responsibilities between it and its next higher echelon (FM 3-90-1)
- forward edge of the battle area** – (DOD) The foremost limits of a series of areas in which ground combat units are deployed, excluding the areas in which the covering or screening forces are operating, designated

to coordinate fire support, the positioning of forces, or the maneuver of units. Also called FEBA. (JP 3-09.3) See ADRP 3-90 and FM 3-90-1.

**forward line of own troops** – (DOD) A line that indicates the most forward positions of friendly forces in any kind of military operation at a specific time. Also called FLOT. (JP 3-03) See FM 3-90-1.

**forward-looking infrared** – (DOD) An airborne, electro-optical thermal imaging device that detects far-infrared energy, converts the energy into an electronic signal, and provides a visible image for day or night viewing. Also called FLIR. (JP 3-09.3) See ATP 3-06.1.

**forward passage of lines** – Occurs when a unit passes through another unit's positions while moving toward the enemy. (ADRP 3-90) See also **passage of lines**; **rearward passage of lines**.

**fratricide** – The unintentional killing or wounding of friendly or neutral personnel by friendly firepower. (ADRP 3-37)

**fragmentary order** – (DOD) An abbreviated form of an operation order issued as needed after an operation order to change or modify that order or to execute a branch or sequel to that order. Also called FRAGORD. (JP 5-0) See ATTP 5-0.1.

**free-fire area** – (DOD) A specific area into which any weapon system may fire without additional coordination with the establishing headquarters. Also called FFA. (JP 3-09) See FM 3-90-1.

**friendly** – (DOD) A contact positively identified as friendly. (JP 3-01) See ADRP 3-37.

**friendly force information requirement** – (DOD) Information the commander and staff need to understand to understand the status of friendly and supporting capabilities. Also called FFIR. (JP 3-0) See ADRP 5-0.

**frontal attack** – A form of maneuver in which the attacking force seeks to destroy a weaker enemy force or fix a larger enemy force in place over a broad front. (FM 3-90-1)

**fusion** – Consolidating, combining, and correlating information together. (ADRP 2-0)

—G—

**gap** – (Army) 1. An area free of armed mines or obstacles whose width and direction allow a friendly force to pass through the area containing obstacles while dispersed in a tactical formation. (ADRP 1-02) 2. Any break or breach in the continuity of tactical dispositions or formations beyond effective small arms coverage. Gaps (soft spots, weaknesses) may in fact be physical gaps in the enemy's disposition, but they also may be any weakness in time, space, or capability; a moment in time when the enemy is overexposed and vulnerable, a seam in an air defense umbrella, an infantry unit caught unprepared in open terrain, or a boundary between two units. 3. A ravine, mountain pass, river, or other terrain feature that presents an obstacle that may be bridged. (ATTP 3-90.4) See also **lane**.

**gap crossing** – The projection of combat power across a linear obstacle (wet or dry gap). (ATTP 3-90.4)

**gap-crossing operation** – A mobility operation consisting of river crossing, brigade-level crossing, and special gap-crossing operations conducted to project combat power across a linear obstacle (wet or dry gap). (ATTP 3-90.4)

**general engineering** – (Army) The engineer discipline that is focused on affecting terrain while not in close support to maneuver forces that are in close combat. (FM 3-34)

**general support** – (DOD) 1. That support which is given to the supported force as a whole and not to any particular subdivision thereof. (JP 3-09.3) See ADRP 5-0 and ATTP 2-01.

**general support-reinforcing** – (Army) A support relationship assigned to a unit to support the force as a whole and to reinforce another similar-type unit. (ADRP 5-0)

**geospatial engineering** – The engineer discipline that is focused on applying geospatial information to improve understanding of terrain for military operations. (FM 3-34)

**geospatial information** – (Army) Foundation information upon which all other information about the physical environment is referenced to form the common operational picture. (ATTP 3-34.80) See also **common operational picture**.

**geospatial intelligence** – (DOD) The exploitation and analysis of imagery and geospatial information to describe, assess, and visually depict physical features and geographically referenced activities on the Earth. Geospatial intelligence consists of imagery, imagery intelligence, and geospatial information. Also called GEOINT. (JP 2-03) See ADRP 2-0, ATP 3-05.20, and ATP 3-60.1.

**global ballistic missile defense** – (DOD) Defense against ballistic missile threats that cross one or more geographical combatant command boundaries and requires synchronization among the affected combatant commands. Also called GBMD. (JP 3-01) See ATP 3-27.5.

**global engagement manager** – Provides automated tools and decision aids that enable commanders to exercise mission command of ballistic missile defense forces deployed within the combatant command area of responsibility. (ATP 3-27.5)

**governance** – (DOD) The state's ability to serve the citizens through the rules, processes, and behavior by which interests are articulated, resources are managed, and power is exercised in a society, including the representative participatory decision-making processes typically guaranteed under inclusive, constitutional authority. (JP 3-24) See FM 3-07.

**ground-based midcourse defense** – (DOD) A surface-to-air ballistic missile defense system for exo-atmospheric midcourse phase interception of long-range ballistic missiles using the ground-based interceptors. Also called GMD. (JP 3-01) See ATP 3-27.5.

**graphic control measure** – A symbol used on maps and displays to regulate forces and warfighting functions. (ADRP 6-0)

**guard** – (Army) A security task to protect the main force by fighting to gain time while also observing and reporting information and preventing enemy ground observation of and direct fire against the main body. Units conducting a guard mission cannot operate independently because they rely upon fires and functional and multifunctional support assets of the main body. (ADRP 3-90)

**guerrilla force** – (DOD) A group of irregular, predominantly indigenous personnel organized along military lines to conduct military and paramilitary operations in enemy-held, hostile, or denied territory. (JP 3-05) See ADRP 3-05.

**gun-target line** – (DOD, NATO) An imaginary straight line from gun to target. Also called GTL. (JP 1-02) See FM 6-30.

—H—

**hasty crossing** – The crossing of an inland water obstacle or other gap using the crossing means at hand or those readily available, and made without pausing for elaborate preparations. (ATTP 3-90.4)

**hasty operation** – An operation in which a commander directs immediately available forces, using fragmentary orders, to perform activities with minimal preparation, trading planning and preparation time for speed of execution. (ADRP 3-90) See also **fragmentary order**.

**hazard** – (DOD) A condition with the potential to cause injury, illness, or death of personnel; damage to or loss of equipment or property; or mission degradation. (JP 3-33) See ADRP 3-37.

**health service support** – (DOD) All services preformed, provided, or arranged to promote, improve, conserve, or restore the mental or physical wellbeing of personnel, which include, but are not limited to, the management of health services resources, such as manpower, monies, and facilities; preventive and curative health measures; evacuation of wounded, injured, or sick; selection of the medically fit and disposition of the medically unfit; blood management; medical supply, equipment, and maintenance thereof; combat and operational stress control; medical, dental, veterinary, laboratory, optometric, nutrition therapy, and medical intelligence services. Also called HSS. (JP 4-02) See ATP 4-02.84 and FM 4-02. (Army) Health service support encompasses all support and services performed, provided, and arranged by

the Army Medical Department to promote, improve, conserve, or restore the mental and physical well-being of personnel in the Army. Additionally, as directed, provide support in other Services, agencies, and organizations. This includes casualty care (encompassing a number of Army Medical Department functions—organic and area medical support, hospitalization, the treatment aspects of dental care and behavioral/neuropsychiatric treatment, clinical laboratory services, and treatment of chemical, biological, radiological, and nuclear patients), medical evacuation, and medical logistics. (FM 4-02)

**high-payoff target** – (DOD) A target whose loss to the enemy will significantly contribute to the success of the friendly course of action. High-payoff targets are those high-value targets that must be acquired and successfully attacked for the success of the friendly commander’s mission. Also called HPT. (JP 3-60) See ATP 3-09.24, ATP 3-60.1, and FM 3-60.

**high-risk personnel** – (DOD) Personnel who, by their grade, assignment, symbolic value, or relative isolation, are likely to be attractive or accessible terrorist targets. Also called HRP. (JP 3-07.2) See ADRP 3-37.

**high-value airborne asset protection** – (DOD) A defensive counterair mission using fighter escorts that defend airborne national assets which are so important that the loss of even one could seriously impact United States warfighting capabilities or provide the enemy with significant propaganda value. Also called HVAA protection. (JP 3-01) See ATP 3-55.6.

**high-value individual** – A high-value individual is a person of interest (friendly, adversary, or enemy) who must be identified, surveilled, tracked and influenced through the use of information or fires. A high-value individual may become a high-payoff target that must be acquired and successfully attacked (exploited, captured, or killed) for the success of the friendly commander’s mission. (FM 3-09)

**high-value target** – (DOD) A target the enemy commander requires for the successful completion of the mission. The loss of high-value targets would be expected to seriously degrade important enemy functions throughout the friendly commander’s area of interest. Also called HVT. (JP 3-60) See ATP 3-09.24, ATP 3-60.1, FM 2-01.3, and FM 3-60.

**holding area** – A waiting area that forces use during traffic interruptions or deployment from an aerial or seaport of embarkation. (FM 3-39)

**homeland** – (DOD) The physical region that includes the continental United States, Alaska, Hawaii, United States possessions and territories, surrounding waters and air space. (JP 3-28) See ADP 3-28.

**homeland defense** – (DOD) The protection of United States sovereignty, territory, domestic population, and critical defense infrastructure against external threats and aggression or other threats as directed by the President. (JP 3-27) See ADRP 3-0 and ADRP 3-28.

**homeland security** – (DOD) A concerted national effort to prevent terrorist attacks within the United States; reduce America’s vulnerability to terrorism, major disasters, and other emergencies; and minimize the damage and recover from attacks, major disasters, and other emergencies that occur. Also called HS. (JP 3-28) See ADRP 3-28.

**hostile criteria** – Description of conditions under which an aircraft or a vehicle may be identified as hostile for engagement purposes. (FM 3-01.7) See also **rules of engagement**.

**host nation** – (DOD) A nation which receives the forces and/or supplies of allied nation and/or NATO organizations to be located on, operate in, or to transit through its territory. Also called HN. (JP 3-57) See ATP 3-57.20 and FM 3-57.

**host-nation support** – (DOD) Civil and/or military assistance rendered by a nation to foreign forces within its territory during peacetime, crisis or emergencies, or war based agreements mutually concluded between nations. Also called HNS. (JP 3-57) See FM 3-57.

**hub** – An organization that sorts and distributes inbound cargo from multiple supply sources. (ATP 4-11)

**human intelligence** – (DOD) A category of intelligence derived from information collected and provided by human sources. (JP 2-0) See ATP 3-05.20. (Army) The collection by a trained human intelligence collector of foreign information from people and multimedia to identify elements, intentions, composition, strength, dispositions, tactics, equipment, and capabilities. Also called HUMINT. (FM 2-22.3) See also **intelligence**.

**humanitarian and civic assistance** – (DOD) Assistance to the local populace provided by predominantly US Forces in conjunction with military operations and exercises. This Assistance is specifically authorized by Title 10, United States Code, Section 401, and funded under separate authorities. Also called HCA. (JP 3-29) See ATP 3-57.20 and FM 3-57.

**humanitarian assistance coordination center** – (DOD) A temporary center established by a geographic combatant commander to assist with interagency coordination and planning. A humanitarian assistance coordination center operates during the early planning and coordination stages of foreign humanitarian assistance operations by providing the link between the geographic combatant commander and other United States Government agencies, nongovernmental organizations, and international and regional organizations at the strategic level. Also called HACC. (JP 3-29) See FM 3-57.

**human resources services** – Includes the key functions of essential personnel services, casualty operations, and postal operations. Human resources services function directly impact a Soldier's status assignment, qualifications, financial status, career progression, and quality of life which allow the Army leadership to effectively manage the force. (ATP 1-0.2)

**human resources support** – The functions and tasks executed within the Army Personnel Life Cycle Model (acquired, develop, distribute, structure, deploy, compensate, transition, and sustain) provides human resources services and support to Soldiers, their families, Department of Defense civilians, and other individuals authorized to accompany the force. Key factions include Man the Force, provide human resources services, coordinate personnel support, and conduct human resources planning and operations. (ATP 1-0.2)

**hybrid threat** – The diverse and dynamic combination of regular forces, irregular forces, terrorist forces, and/or criminal elements unified to achieve mutually benefitting effects. (ADRP 3-0)



**imagery** – (DOD) A likeness or presentation of any natural or man-made feature or related object or activity, and the positional data acquired at the same time the likeness or presentation was acquired, including: product produced by space-based national intelligence reconnaissance systems; and likeness and presentations produced by satellites, airborne platforms, unmanned aerial vehicles, or other similar means (except that such term does not include handheld or clandestine photography taken by or on behalf of human intelligence collection organizations). (JP 2-03) See ATP 3-55.6 and ATP 3-55.12.

**imagery exploitation** – (DOD) The cycle of processing, using, interpreting, mensuration and/or manipulating imagery, and any assembly or consolidation of the results of dissemination. (JP 2-03) See ATP 3-55.6.

**imagery intelligence** – (DOD) The technical, geographic, and intelligence information derived through the interpretation or analysis of imagery and collateral materials. Also called IMINT. (JP 2-03) See ATP 3-05.20.

**immediate response authority** – (DOD) A Federal military commander's, Department of Defense component head's, and/or responsible Department of Defense civilian official's authority temporarily to employ resources under their control, subject to any supplemental direction provided by higher headquarters, and provide those resources to save lives, prevent human suffering, or mitigate great property damage in response to a request for assistance from civil authority, under imminently serious conditions when time does not permit approval from a higher authority within the United States. Immediate response authority does not permit actions that would subject civilians to the use of military power that is regulatory, prescriptive, proscriptive, or compulsory. (DODD 3025.18) See ADP 3-28, ADRP 3-28, and ATP 3-28.1.

**improvisation** – The ability to adapt sustainment operations to unexpected situations or circumstances affecting a mission. (ADP 4-0)

**implied task** – (Army) A task that must be performed to accomplish a specified task or mission but is not stated in the higher headquarters' order. (ATTP 5-0.1) See also **essential task**; **specified task**.

- incident** – (DOD) An occurrence, caused by either human action or natural phenomena, that requires action to prevent or minimize loss of life or damage to property and/or natural resources. (JP 3-28) See ADP 3-28, ADRP 3-28, and ATP 3-28.1.
- incident command system**– (DOD) A standard on-scene emergency management construct designed to aid in the management of resources during incidents. Consists of facilities, equipment, personnel, procedures, and communications established for this purpose. Also called ICS. (JP 3-28) See ATP 3-28.1.
- incident management** – (DOD) A national comprehensive approach to preventing, preparing for, responding to, and recovering from terrorist attacks, major disasters, and other emergencies. Incident management includes measures and activities performed at the local, state, and national levels and includes both crisis and consequence management activities. (JP 3-28) See ADP 3-28 and ATP 3-28.1.
- indicator** – (Army) In the context of assessment, an Item of information that provides insight into a measure of effectiveness or measure of performance. (ADRP 5-0) See also **intelligence**.
- indigenous populations and institutions** – The civilian construct of an area of operations, to include its population (legal citizens, legal and illegal immigrants, and all categories of dislocated civilians), governmental, tribal, commercial, and private organizations and entities. Also called IPI. (FM 3-57)
- indirect approach** – The manner in which a commander attacks the enemy's center of gravity by applying combat power against a series of decisive points while avoiding enemy strength. (ADRP 3-90)
- individual initiative** – The willingness to act in the absence of orders, when existing orders no longer fit the situation, or when unforeseen opportunities or threats arise. (ADRP 3-0)
- individual protective equipment** – (DOD) In chemical, biological, radiological, or nuclear operations, the personal clothing and equipment required to protect an individual from chemical, biological, and radiological hazards. Also called IPE. (JP 3-11) See ATP 4-02.84.
- infiltration** – (Army) A form of maneuver in which an attacking force conducts undetected movement through or into an area occupied by enemy forces to occupy a position of advantage in the enemy rear while exposing only small elements to enemy defensive fires. (FM 3-90-1)
- infiltration lane** – A control measure that coordinates forward and lateral movement of infiltrating units and fixes fire planning responsibilities. (FM 3-90-1) See also **infiltration**.
- inform and influence activities** – The integration of designated information-related capabilities in order to synchronize themes, messages and actions with operations to inform United States and global audiences, influence foreign audiences, and affect adversary and enemy decisionmaking. (ADRP 3-0)
- information** – The meaning that a human assigns to data by means of the known conventions used in their representation. (ADRP 1-02)
- information collection** – An activity that synchronizes and integrates the planning and employment of sensors and assets as well as the processing, exploitation, and dissemination systems in direct support of current and future operations. (FM 3-55)
- information environment** – (DOD) The aggregate of individuals, organizations, and systems that collect, process, disseminate, or act on information. (JP 3-13) See ATP 3-05.20 and FM 3-13.
- information fratricide** – The result of employing information-related capabilities in a way that causes effects in the information environment that impede the conduct of friendly operations or adversely affect friendly forces. (FM 3-13)
- information management** – (Army) The science of using procedures and information systems to collect, process, store, display, disseminate, and protect data, information, and knowledge products. (ADRP 6-0) See also **situational understanding**.
- information operations** – (DOD) The integrated employment, during military operations, of information-related capabilities in concert with other lines of operation to influence, disrupt, corrupt, or usurp the decision-making of adversaries and potential adversaries while protecting our own. Also called IO. (JP 3-13) See ATP 3-55.12.

**information protection** – Active or passive measures used to safeguard and defend friendly information and information systems. (ADRP 6-0)

**information-related capabilities** – Capabilities, techniques, or activities employing information to affect any of the three dimensions within the information environment to generate ends. (FM 3-13)

**information requirement(s)** – (DOD) In intelligence usage, those items of information regarding the adversary and other relevant aspects of the operational environment that need to be collected and processed in order to meet the intelligence requirements of a commander. (JP 2-0) See ADRP 2-0 and ATP 3-55.6. (Army) Any information elements the commander and staff require to successfully conduct operations. (ADRP 6-0)

**information superiority** – (DOD) The operational advantage derived from the ability to collect, process, and disseminate an uninterrupted flow of information while exploiting or denying an adversary’s ability to do the same. (JP 3-13) See FM 3-57.

**information system** – (Army) Equipment that collects, processes, stores, displays, and disseminates information. This includes computers—hardware and software—and communications, as well as policies and procedures for their use. (ADP 6-0)

**infrastructure** – The basic underlying framework or feature of a thing: in economics, basic resources, communications, industries, and so forth, upon which others depend; in insurgency, the organization (usually hidden) of insurgent leadership. (FM 2-01.3)

**initial response force** – (Army) A unit designated by the commander to respond to threat attacks or emergency situations. The initial response force is typically task-organized for the specific threat or incident to which it is tasked to respond and may include military police; firefighters; chemical, biological, radiological, and nuclear personnel; and medical personnel. (FM 3-39)

**institutional training domain** – The Army’s institutional training and education system, which primarily includes training base centers and schools that provide initial training and subsequent professional military education for Soldiers, military leaders, and Army civilians. (ADP 7-0)

**insurgency** – (DOD) The organized use of subversion and violence by a group or movement that seeks to overthrow or force change of a governing authority. Insurgency can also refer to the group itself. (JP 3-24) See ADRP 3-05, FM 3-07, and FM 3-57.

**integrated air and missile defense** – (DOD) The integration of capabilities and overlapping operations to defend the homeland and United States national interests, protect the joint force, and enable freedom of action by negating an adversary’s ability to create adverse effects from their air and missile capabilities. Also called IAMD. (JP 3-01) See ATP 3-27.5.

**integration** – (Army) Combining all of the elements of sustainment (task, functions, systems, processes, organizations) to operations assuring unity of command of effort. (ADP 4-0)

**intelligence** – (DOD) The product resulting from the collection, processing, integration, evaluation, analysis, and interpretation of available information concerning foreign nations, hostile or potentially hostile forces or elements, or areas of actual or potential operations. The term is also applied to the activity which results in the product and to the organizations engaged in such activity. (JP 2-0) See ADRP 2-0, FM 3-07, and ATP 3-55.6.

**intelligence analysis** – The process by which collected information is evaluated and integrated with existing information to facilitate intelligence production. (ADRP 2-0)

**intelligence community** – (DOD) All departments or agencies of a government that are concerned with intelligence activity, either in an oversight, managerial, support, or participatory role. (JP 1-02) See ADRP 2-0.

**intelligence operations** – The tasks and actions undertaken by military intelligence organizations and Soldiers to obtain information to satisfy validated requirements. (ADRP 2-0)

**intelligence preparation of the battlefield** – (Army) A systematic process of analyzing and visualizing the portions of the mission variables of threat, terrain, weather, and civil considerations in a specific area of

interest and for a specific mission. By applying intelligence preparation of the battlefield commanders gain the information necessary to selectively apply and maximize operational effectiveness at critical points in time and space. Also called IPB. (FM 2-01.3)

**intelligence preparation of the battlespace** – (DOD) The analytical methodologies employed by the Services or joint force component commands to reduce uncertainties concerning the enemy, environment, time, and terrain. Intelligence preparation of the battlespace supports the individual operations of the joint force component commands. Also called IPB. (JP 2-01.3) See ATP 3-05.20.

**intelligence process** – (DOD) The process by which information is converted into intelligence and made available to users, consisting of the six interrelated intelligence operations: planning and direction, collection, processing and exploitation, analysis and production, dissemination and integration, and evaluation and feedback. (JP 2-01) See ATP 3-55.6.

**intelligence reach** – A process by which intelligence organizations proactively and rapidly access information from, receive support from, and conduct direct collaboration and information sharing with other units and agencies, both within and outside the area of operations, unconstrained by geographic proximity, echelon, or command. (ADRP 2-0)

**intelligence requirement** – (DOD) 1. Any subject, general or specific, upon which there is a need for the collection of information, or the production of intelligence. 2. A requirement for intelligence to fill a gap in the command's knowledge or understanding of the operational environment or threat forces. (JP 2-0) See ATP 3-05.20.

**intelligence, surveillance, and reconnaissance** – (DOD) An activity that synchronizes and integrates the planning and operation of sensors, assets, and processing, exploitation, and dissemination systems in direct support of current and future operations. This is an integrated intelligence and operations function. (JP 2-01) See ADRP 2-0 and ATP 3-55.6.

**intelligence synchronization** – The “art” of integrating information collection and intelligence analysis with operations to effectively and efficiently support decisionmaking. (ADRP 2-0)

**intelligence warfighting function** – The related tasks and systems that facilitate understanding the enemy, terrain, and civil considerations. (ADRP 3-0) See also **warfighting function**.

**interagency** – (DOD) Of or pertaining to United States Government agencies and departments, including the Department of Defense. (JP 3-08) See ATP 1-06.2, ATP 3-57.20, and FM 3-07.

**interagency coordination** – (DOD) Within the context of Department of Defense involvement, the coordination that occurs between elements of Department of Defense, and engaged US Government agencies and departments for the purpose of achieving an objective. (JP 3-0) See ADRP 3-0, FM 3-07, and ATP 3-57.20.

**interdict** – A tactical mission task where the commander prevents, disrupts, or delays the enemy's use of an area or route. (FM 3-90-1) See also **delay; disrupt; tactical mission task**.

**intergovernmental organization** – (DOD) An organization created by a formal agreement between two or more governments on a global, regional, or functional basis to protect and promote national interests shared by member states. Also called IGO. (JP 3-08) See ADRP 3-0, ATP 3-57.20, FM 3-07, and FM 3-50.1.

**interior lines** – Lines on which a force operates when its operations diverge from a central point. (ADRP 3-0)

**intermediate staging base** – (DOD) A tailorable, temporary location used for staging forces, sustainment and/or extraction into and out of an operational area. Also called ISB. (JP 3-35) See ADRP 3-0.

**intermodal operations** – The process of using multiple modes (air, sea, highway, rail) and conveyances (i.e. truck, barge, containers, pallets) to move troops, supplies and equipment through expeditionary entry points and the networks of specialized transportation nodes to sustain land forces. (ADRP 4-0)

**internment and resettlement operations** – Conducted by military police to shelter, sustain, guard, protect, and account for populations (detainees or dislocated civilians) as a result of military or civil conflict, natural or man-made disaster, or to facilitate criminal prosecution. Internment involves the detainment of a population or group that pose some level of threat to military operations. Resettlement involves the quartering of a



population or group for their protection. These operations inherently control the movement and activities of their specific population for imperative reasons of security, safety, or intelligence gathering. (FM 3-39.40)

**internal defense and development** – (DOD) The full range of measures taken by a nation to promote its growth and to protect itself from subversion, lawlessness, insurgency, terrorism, and other threats to its security. Also called IDAD. (JP 3-22) See ADRP 3-07, ATP 3-57.20, and FM 3-57.

**internally displaced person** – (DOD) Any person who has been forced to flee or to leave their home or place of habitual residence, in particular as a result of or in order to avoid the effects of armed conflict, situations of generalized violence, violations of human rights or natural or human-made disasters, and who have not crossed an internationally recognized state border. (JP 3-29) See FM 3-57.

**interorganizational coordination** – (DOD) The interaction that occurs among elements of the Department of Defense; engaged United States Government agencies; state, territorial, local, and tribal agencies; foreign military forces and government agencies; intergovernmental organizations; nongovernmental organizations; and the private sector. (JP 3-08) See ADRP 3-0.

**interzonal operations** – Operations which cross area of operation boundaries of a specific transportation organization and operate under the area control of more than one headquarters or command. (ATP 4-11)

**in-transit visibility** – (DOD) The ability to track the identity, status, and location of Department of Defense units, and non-unit cargo (excluding bulk petroleum, oils, and lubricants) and passengers; patients, and personal property from origin to consignee or destination across the range of military operations. Also called ITV. (JP 4-01.2) See ADP 4-0.

**intrazonal operations** – Operations confined within a specific transportation organization's area of operation. (ATP 4-11)

**irregular warfare** – (DOD) A violent struggle among state and non-state actors for legitimacy and influence over the relevant population(s). Irregular warfare favors indirect and asymmetric approaches, though it may employ the full range of military and other capacities, in order to erode an adversary's power, influence, and will. Also called IW. (JP 1) See ADRP 3-05 and ATP 3-07.5.

**isolate** – A tactical mission task that requires a unit to seal off—both physically and psychologically—an enemy from sources of support, deny the enemy freedom of movement, and prevent the isolated enemy force from having contact with other enemy forces. (FM 3-90-1) See also **encirclement**; **tactical mission task**.

**isolated personnel report** – (DOD) A Department of Defense form (DD 1833) containing information designed to facilitate the identification and authentication of an isolated person by a recovery force. Also called ISOPREP. (JP 3-50) See ATP 3-50.3.



**joint** – (DOD) Connotes activities, operations, organizations, etc., in which elements of two or more Military Departments participate. (JP 1) See ATP 3-05.20.

**joint fire support** – (DOD) The joint fires that assist air, land, maritime, and special operations forces to move, maneuver, and control territory, populations, airspace, and key waters. (JP 3-0) See ADRP 3-09.

**joint fires** – (DOD) Fires delivered during the employment of forces from two or more components in coordinated action to produce desired effects in support of a common objective. (JP 3-0) See ADP 3-09 and ADRP 3-09.

**joint fires observer** – A trained and certified Service member who can request, adjust, and control surface-to-surface fires, provide targeting information in support of Type 2 and 3 close air support terminal attack controls, and perform autonomous terminal guidance operations. (ADRP 1-02) See ADRP 3-09.

**joint force** – (DOD) A general term applied to a force composed of significant elements, assigned or attached, of two or more Military Departments operating under a single joint force commander. (JP 3-0) See ATP 3-05.20.

**joint force special operations component commander** – (DOD) The commander within a unified command, subordinate unified command, or joint task force responsible to the establishing commander for recommending the proper employment of assigned, attached, and/or made available for tasking special operations forces and assets; planning and coordinating special operations; or accomplishing such operational missions as may be assigned. Also called JFSOCC. (JP 3-05) See ADRP 3-05.

**joint intelligence preparation of the operational environment** – (DOD) The analytical process used by joint intelligence organizations to produce intelligence estimates and other intelligence products in support of the joint force commander's decision-making process. It is a continuous process that includes defining the operational environment; describing the impact of the operational environment; evaluating the adversary; and determining adversary courses of action. Also called JIPOE. (JP 2-01.3) See ATP 3-05.20.

**joint operations** – (DOD) A general term to describe military actions conducted by joint forces and those Service forces employed in specified command relationships with each other, which of themselves, do not establish joint forces. (JP 3-0) See ATP 3-05.20.

**joint personnel recovery center** – (DOD) The primary joint force organization responsible for planning and coordination personnel recovery for military operations within the assigned operational area. Also called JPRC. (JP 3-50) See FM 3-50.1.

**joint special operations air component commander** – (DOD) The commander within a force special operations command responsible for planning and executing joint special operations air activities. Also called JFSOACC. (JP 3-05) See ADP 3-05.

**joint special operations area** – (DOD) An area of land, sea, and airspace assigned by a joint force commander to the commander of a joint special operations force to conduct special operations activities. Also called JSOA. (JP 3-0) See ADRP 3-05.

**joint special operations task force** – (DOD) A joint task force composed of special operations units from more than one Service, formed to carry out a specific special operation or prosecute special operations in support of a theater campaign or other operations. Also called JSOTF. (JP 3-05) See ADRP 3-05.

**joint task force** – (DOD) A joint force that is constituted and so designated by the Secretary of Defense, a combatant commander, subunified commander, or an existing joint task force commander. Also called JTF. (JP 1) See FM 3-57.

—K—

**key tasks** – Those activities the force must perform as a whole to achieve the desired end state. (ADRP 5-0)

**key terrain** – (DOD) Any locality, or area, the seizure or retention of which affords a marked advantage to either combatant. (JP 2-01.3) See FM 2-01.3 and FM 3-90-1.

**kill box** – A three-dimensional fire support coordination measure used to facilitate the expeditious air-to-surface lethal attack of targets, which may be augmented by or integrated with surface-to-surface indirect fires. (FM 3-09.34)

**kill zone** – That part of an ambush site where fire is concentrated to isolate, fix, and destroy the enemy. See also **ambush; destroy; fix; isolate**. (FM 3-90-1)

**knowledge** – Information that has been analyzed to provide meaning and value or evaluated as to implications for the operation. (FM 6-01.1)

**knowledge creation** – The process of developing new knowledge or combining, restructuring, or repurposing existing knowledge in response to identified knowledge gaps. (FM 6-01.1)

**knowledge management** – The art of creating, organizing, applying, and transferring knowledge to facilitate situational understanding, learning, and decisionmaking. (ADRP 6-0)

—L—

- landing zone** – (DOD) Any specific zone used for the landing of aircraft. Also called LZ. (JP 3-17) See ATP 3-60.1.
- landpower** – The ability—by threat, force, or occupation—to gain, sustain, and exploit control over land, resources, and people. (ADRP 3-0)
- lane** – A route through, over, or around an enemy or friendly obstacle that provides safe passage of a passing force. The route may be reduced and proofed as part of a breaching operation, constructed as part of the obstacle, or marked as a bypass. (ATTP 3-90.4)
- lateral boundy** – A boundary that extends from the rear boundary to the unit’s forward boundary. (FM 3-90-1)
- latest time information is of value** – The time by which an intelligence organization or staff must deliver information to the requestor in order to provide decisionmakers with timely intelligence. This must include the time anticipated for processing and disseminating that information as well as for making the decision. Also called LTIOV. (FM 2-01.3)
- law and order operations** – Encompass policing and the associated law enforcement activities to control and protect populations and resources to facilitate the existence of a lawful and orderly environment. (FM 3-39)
- law of war** – (DOD) That part of international law that regulates the conduct of armed hostilities. Also called the law of armed conflict. (JP 1-04) See ATP 3-60.1. (Army) Also called the law of armed conflict—is that part of international law that regulates the conduct of armed hostilities. (FM 27-10)
- leader development** – Leader development is a deliberate, continuous, sequential, and progressive process grounded in the Army Values. It grows Soldiers and Army Civilians into competent, confident leaders capable of directing teams and organizations. (AR 350-1) See ADRP 6-22.
- leadership** – The process of influencing people by providing purpose, direction, and motivation to accomplish the mission and improve the organization. (ADP 6-22)
- liaison** – (DOD) That contact or intercommunication maintained between elements of military forces or other agencies to ensure mutual understanding and unity of purpose and action. (JP 3-08) See ADRP 5-0.
- light line** – A designated line forward of which vehicles are required to use black-out lights at night. Also called LL. (ADRP 1-02)
- limit of advance** – A phase line used to control forward progress of the attack. The attacking unit does not advance any of its elements or assets beyond the limit of advance, but the attacking unit can push its security forces to that limit. Also called LOA. (ADRP 3-90)
- line formation** – When a unit’s subordinate ground maneuver elements move abreast of each other. (FM 3-90-1)
- line haul** – An operation in which vehicles cannot make more than one round trip per day due to distance, terrain restrictions, or transit time. (ATP 4-11)
- line of communications** – (DOD) A route, either land, water, and/or air, that connects an operating military force with a base of operations and along which supplies and military forces move. Also called LOC. (JP 2-01.3) See FM 3-90-1.
- line of communications bridging** – Bridges used to establish semipermanent or permanent support to road networks. (ATTP 3-90.4)
- line of contact** – A general trace delineating the locations where friendly and enemy forces are engaged. (FM 3-90-1) See also **forward edge of the battle area; forward line of own troops; line of departure**.
- line of departure** – (Army) A phase line crossed at a prescribed time by troops initiating an offensive operation. Also called LD. (ADRP 3-90) See also **line of contact; phase line**.
- line of effort** – (Army) A line that links multiple tasks using the logic of purpose rather than geographical reference to focus efforts toward establishing operational and strategic conditions. (ADRP 3-0)

**line of operations** – (Army) A line that defines the directional orientation of a force in time and space in relation to the enemy and links the force with its base of operations and objectives. (ADRP 3-0)

**line of sight** – An unobstructed path from a Soldier’s weapon, weapon sight, electronic sending and receiving antennas, or piece of reconnaissance equipment to another point. (FM 2-01.3)

**link** – (DOD) 1. A behavioral, physical, or functional relationship between nodes. (JP 3-0) See FM 3-57.

**linkup** – A meeting of friendly ground forces, which occurs in a variety of circumstances. (ADRP 3-90)

**linkup point** – The point where two infiltrating elements in the same or different infiltration lanes are scheduled to meet to consolidate before proceeding on with their missions. (FM 3-90-1)

**local haul** – An operation in which vehicles can make two or more round trips per day based on distance and transit time. (ATP 4-11)

**local security** – A security task that includes low-level security activities conducted near a unit to prevent surprise by the enemy. (ADRP 3-90) See also **security operations**.

**lodgment** – (DOD) A designated area in a hostile or potentially hostile operational area that, when seized and held, makes the continuous landing of troops and materiel possible and provides maneuver space for subsequent operations. (JP 3-18) See ADRP 3-0.

**logistics** – (Army) Planning and executing the movement and support of forces. It includes those aspects of military operations that deal with: design and development, acquisition, storage, movement, distribution, maintenance, evacuation and disposition of materiel, acquisition or construction, maintenance, operation, and disposition of facilities, and acquisition or furnishing of services. (ADP 4-0)

**logistics package** – A grouping of multiple classes of supply and supply vehicles under the control of a single convoy commander. Also called LOGPAC. (FM 3-90-1) See also **classes of supply**.

—M—

**main battle area** – The area where the commander intends to deploy the bulk of the unit’s combat power and conduct decisive operations to defeat an attacking enemy. Also called MBA. (ADRP 3-90) See also **combat power; defensive operations; forward edge of the battle area; handover line**.

**main body** – The principal part of a tactical command or formation. It does not include detached elements of the command, such as advance guards, flank guards, and covering forces. (ADRP 3-90) See also **covering force; flank guard**.

**main command post** – A facility containing the majority of the staff designed to control current operations, conduct detailed analysis, and plan future operations. (ATTP 5-0.1)

**main effort** – A designated subordinate unit whose mission at a given point in time is most critical to overall mission success. (ADRP 3-0)

**main supply route** – (DOD) The route or routes designated within an operational area upon which the bulk of traffic flows in support of military operations. Also called MSR. (JP 4-01.5) See FM 3-90-1.

**major operation** – (DOD) 1. A series of tactical actions (battles, engagements, strikes) conducted by combat forces of a single or several Services, coordinated in time and place, to achieve strategic or operational objectives in an operational area. 2. For noncombat operations, a reference to the relative size and scope of a military operation. (JP 3-0) See ADRP 3-0 and ATP 3-07.5.

**man the force** – Manning combines anticipation, movement, and skillful positioning of personnel so that the commander has the personnel required to accomplish the mission. Manning the force involves human resources functions of personnel readiness management, personnel accountability, strength reporting, retention, and personnel information management. Man the force ensures the right person is in the right positions with the right skills and training at the right time. (ATP 1-0.2)

**maneuver** – (DOD) 1. A movement to place ships, aircraft, or land forces in a position of advantage over the enemy. See FM 3-07. 2. A tactical exercise carried out at sea, in the air, on the ground, or on a map in

imitation of war. See FM 3-07. 3. The operation of a ship, aircraft, or vehicle, to cause it to perform desired movements. See FM 3-07. 4. Employment of forces in the operational area through movement in combination with fires to achieve a position of advantage in respect to the enemy. (JP 3-0) See ADP 3-90, ADRP 3-90, and FM 3-07.

**maneuver and mobility support** – A military police function conducted to support and preserve the commander's freedom of movement and enhance the movement of friendly resources in all environments. (FM 3-39)

**march column** – A march column consists of all elements using the same route for a single movement under control of a single commander. (FM 3-90-2) See also **march serial**; **march unit**.

**march serial** – A major subdivision of a march column that is organized under one commander who plans, regulates, and controls the serial. (FM 3-90-2) See also **march column**; **march unit**.

**march unit** – A subdivision of a march serial. It moves and halts under the control of a single commander who uses voice and visual signals. (FM 3-90-2) See also **march column**; **march serial**.

**measurement and signature intelligence** – (DOD) Intelligence obtained by quantitative and qualitative analysis of data (metric, angle, spatial, wavelength, time dependence, modulation, plasma, and hydromagnetic) derived from specific technical sensors for the purpose of identifying any distinctive features associated with the emitter or sender, and to facilitate subsequent identification and/or measurement of the same. The detected feature may be either reflected or emitted. Also called MASINT. (JP 2-0) See ATP 3-05.20.

**measure of effectiveness** – (DOD) A criterion used to assess changes in system behavior, capability, or operational environment that is tied to measuring the attainment of an end state, achievement of an objective, or creation of an effect. (JP 3-0) See ADRP 3-07, ADRP 3-37, ADRP 5-0, ATP 3-09.24, ATP 3-57.20, and FM 3-57.

**measure of performance** – (DOD) A criterion used to assess friendly actions that is tied to measuring task accomplishment. (JP 3-0) See ADRP 5-0, FM 3-57, ATP 3-09.24, and ATP 3-57.20.

**media source analysis** – The systematic comparison of the content, behavior, patterns, and trends of organic media organizations and sources of a country. (ATP 2-22.9)

**meeting engagement** – A combat action that occurs when a moving force, incompletely deployed for battle, engages an enemy at an unexpected time and place. (FM 3-90-1)

**mentorship** – The voluntary developmental relationship that exists between a person of greater experience and a person of lesser experience that is characterized by mutual trust and respect. (AR 600-100) See ADRP 6-22.

**midcourse phase** – (DOD) That portion of the flight of a ballistic missile between the boost phase and the terminal phase. (JP 3-01) See ATP 3-27.5.

**military civic action** – (DOD) The use of preponderantly indigenous military forces on projects useful to the local population at all levels in such fields as education, training, public works, agriculture, transportation, communications, health, sanitation, and others contributing to economic and social development, which would also serve to improve the standing of the military forces with the population. (US forces may at times advise or engage in military civil actions in overseas areas) (JP 3-57) See FM 3-57 and ATP 3-57.20.

**military crest** – An area on the forward slope of a hill or ridge from which maximum observation covering the slope down to the base of the hill or ridge can be obtained. (FM 3-25.26)

**military deception** – (DOD) Actions executed to deliberately mislead adversary military decision makers as to friendly military capabilities, intentions, and operations, thereby causing the adversary to take specific actions (or inactions) that will contribute to the accomplishment of the friendly mission. Also called MILDEC. (JP 3-13.4) See ADRP 6-0.

**military decisionmaking process** – An interactive planning methodology to understand the situation and mission, develop a courses of action, and produce an operation plan or order. Also called MDMP. (ADP 5-0) See also **operation order**; **operation plan**.

**military engagement** – (DOD) Routine contact and interaction between individuals or elements of the Armed Forces of the United States and those of another nation’s armed forces, or foreign and domestic civilian authorities or agencies to build trust and confidence, share information, coordinate mutual activities, and maintain influence. (JP 3-0) See FM 3-07.

**military expertise** – The design, generation, support, and ethical application of landpower, primarily in unified land operations, and all supporting capabilities essential to accomplish the mission in defense of the American people. (ADRP 1)

**military information support operations** – (DOD) Planned operations to convey selected information and indicators to foreign audiences to influence their emotions, motives, objective reasoning, and ultimately the behavior of foreign governments, organizations, groups, and individuals in a manner favorable to the originator’s objectives. Also called MISO. (JP 3-13.2) See ADP 3-05 and ADRP 3-05.

**misinformation** – Incorrect information from any source that is released for unknown reasons or to solicit a response or interest from a non-political or nonmilitary target. (FM 3-53)

**missile defense** – (DOD) Defense measures designed to destroy attacking enemy missiles, or to nullify or reduce the effectiveness of such attack. (JP 3-01) See ATP 3-55.6.

**mission** – (DOD) 1. The task, together with the purpose, that clearly indicates the action to be taken and the reason therefore. (JP 3-0) See ADP 5-0, ADRP 5-0, and FM 3-07.

**mission command** – (Army) The exercise of authority and direction by the commander using mission orders to enable disciplined initiative within the commander’s intent to empower agile and adaptive leaders in the conduct of unified land operations. (ADP 6-0) See also **commander’s intent; mission orders**. (DOD) The conduct of military operations through decentralized execution based upon mission-type orders. (JP 3-31) See ATP 3-06.1.

**mission command system** – The arrangement of personnel; networks; information systems; processes and procedures; and facilities and equipment that enable commanders to conduct operations. (ADP 6-0)

**mission command warfighting function** – The related tasks and systems that develop and integrate those activities enabling a commander to balance the art of command and the science of control in order to integrate the other warfighting functions. (ADRP 3-0)

**mission creep** – Tangential efforts to assist in areas of concern unrelated to assigned duties that cripple efficient mission accomplishment. (FM 3-16)

**mission-essential task** – A task a unit could perform based on its design, equipment, manning, and table of organization and equipment/table of distribution and allowances mission. (ADRP 7-0) See also **mission-essential task list**.

**mission-essential task list** – A compilation of collective mission-essential tasks. Also called METL. (ADRP 7-0) See also **mission-essential task**.

**mission orders** – Directives that emphasize to subordinates the results to be attained, not how they are achieved. (ADP 6-0) See also **mission command**.

**mixing** – Using two or more different assets to collect against the same intelligence requirement. (FM 3-90-2)

**mobile defense** – A defensive task that concentrates on the destruction or defeat of the enemy through a decisive attack by a striking force. (ADRP 3-90)

**mobility** – A quality or capacity of military forces which permits them to move from place to place while retaining the ability to fulfill their primary mission. (JP 3-17) See ADRP 3-90 and FM 3-90-1.

**mobility operations** – Those combined arms activities that mitigate the effects of natural and manmade obstacles to enable freedom of movement and maneuver. (ATTP 3-90.4) See also **breach; countermobility operations**.

**mode operations** – The execution of movements using various conveyances (truck, lighterage, railcar, aircraft) to transport cargo. (ADRP 4-0)

- monitoring** – Continuous observation of those conditions relevant to the current operation. (ADRP 5-0)
- morale, welfare, recreation, and community support activities** – Programs that provide Soldiers, Army civilians, and other authorized personnel with recreational and fitness activities, goods, and services. The moral, welfare, recreation network provides unit recreation and sports programs and rest areas for brigade-sized and larger units. Community support programs include the American Red Cross and family support. (ATP 1-0.2)
- motor transportation** – A ground support transportation function that includes moving and transferring units, personnel, equipment and supplies by vehicle to support the operations. (ATP 4-11)
- movement and maneuver warfighting function** – The related tasks and systems that move and employ forces to achieve a position of advantage over the enemy and other threats. (ADRP 3-0) See also **warfighting function**.
- movement control** – (DOD) The planning, routing, scheduling, and control of personnel and cargo movements over lines of communications, includes maintaining in-transit visibility of forces and material through the deployment and/or redeployment process. (JP 3-10) See ADRP 3-90. (Army) The dual process of committing allocated transportation assets and regulating movements according to command priorities to synchronize distribution flow over lines of communications to sustain land forces. (ADRP 4-0)
- movement corridor** – A designated area established to protect and enable ground movement along a route. (FM 3-90.31)
- movement to contact** – (Army) An offensive task designed to develop the situation and establish or regain contact. (ADRP 3-90)
- mounted march** – The movement of troops and equipment by combat and tactical vehicles. (FM 3-90-2)
- multiechelon training** – A training technique that allows for the simultaneous training of more than one echelon on different or complementary tasks. (ADRP 7-0)
- multinational operations** – (DOD) A collective term to describe military actions conducted by forces of two or more nations, usually undertaken within the structure of a coalition or alliance. (JP 3-16) See ADRP 3-0, FM 3-07, and FM 3-16.
- mutual support** – (DOD) That support which units render each other against an enemy, because of their assigned tasks, their position relative to each other and to the enemy, and their inherent capabilities. (JP 3-31) See ADRP 3-0.

—N—

- named area of interest** – (DOD) A geospatial area or systems node or link against which information that will satisfy a specific information requirement can be collected. Named areas of interest are usually selected to capture indications of adversary courses of action, but also may be related to conditions of the operational environment. Also called NAI. (JP 2-01.3) See FM 2-01.3 and ATP 3-55.6. (Army) The geographical area where information that will satisfy a specific information requirement can be collected. Also called NAI. (ADRP 1-02)
- national defense strategy** – (DOD) A document approved by the Secretary of Defense for applying the Armed Forces of the United States in coordination with Department of Defense agencies and other instruments of national power to achieve national security strategy objectives. Also called NDS. (JP 1) See ADRP 3-28.
- National Incident Management System** – (DOD) A national crisis response system that provides a consistent, nationwide approach for Federal, state, local, and tribal governments; the private sector; and nongovernmental organizations to work effectively and efficiently together to prepare for, respond to, and recover from domestic incidents, regardless of cause, size or complexity. Also called NIMS. (JP 3-41) See ADP 3-28 and ATP 3-28.1.
- national military strategy** – (DOD) A document approved by the Chairman of the Joint Chiefs of Staff for distributing and applying military power to attain national security strategy and national defense strategy objectives. Also called NMS. (JP 1) See ADRP 3-28.

**national security strategy** – (DOD) A document approved by the President of the United States for developing, applying, and coordinating the instruments of national power to achieve objectives that contribute to national security. Also called NSS. (JP 1) See ADRP 3-28.

**nation assistance** – (DOD) Assistance rendered to a nation by foreign forces within that nation's territory based on agreements mutually concluded between nations. (JP 3-0) See FM 3-57 and ATP 3-57.20.

**nested concept** – A planning technique to achieve unity of purpose whereby each succeeding echelon's concept of operations is aligned by purpose with the higher echelon's concept of operations. (ADRP 5-0) See also **concept of operations**.

**net control station** – A communications station designated to control traffic and enforce circuit discipline within a given net. Also called NCS. (ADRP 1-02)

**neutral** – (DOD) In combat and combat support operations, an identity applied to a track whose characteristics, behavior, origin, or nationality indicate that it is neither supporting nor opposing friendly forces (JP 3-0) See FM 3-07. (Army) A party identified as neither supporting nor opposing friendly or enemy forces. (ADRP 3-0)

**neutralization** – In the context of the computed effects of field artillery fires, neutralization renders a target ineffective for a short period of time, producing 10-percent casualties or materiel damage. (FM 3-09)

**neutralize** – (Army) A tactical mission task that results in rendering enemy personnel or materiel incapable of interfering with a particular operation. (FM 3-90-1)

**night vision device** – (DOD) Any electro-optical device that is used to detect visible and near-infrared energy, and provide a visible image. Night vision goggles, forward-looking infrared, thermal sights, and low-light level television are night vision devices. Also called NVD. (JP 3-09.3) See ATP 3-06.1.

**night vision goggle(s)** – (DOD) An electro-optical image intensifying device that detects visible and near-infrared energy, intensifies the energy, and provides a visible image for night viewing. Night vision goggles can be either hand-held or helmet-mounted. Also called NVG. (JP 3-09.3) See ATP 3-06.1.

**no-strike list** – (DOD) A list of objectives or entities characterized as protected from the effects of military operations under international law and/or rules of engagement. Also called NSL. (JP 3-60) See ADRP 3-09.

**no-fire area** – (DOD) An area designated by the appropriate commander into which fires or their effects are prohibited. (JP 3-09) Also called NFA. See FM 3-09-1.

**nonappropriated funds** – (DOD) Funds generated by Department of Defense personnel and their dependents used to augment funds appropriated by the Congress to provide a comprehensive, morale-building welfare, religious, educational, and recreational programs. Also called NAF. (JP 1-0)

**noncombat evacuation operations** – (DOD) Operations directed by the Department of State or other appropriate authority, in conjunction with the Department of Defense, whereby noncombatants are evacuated from foreign countries when their lives are endangered by war, civil unrest, or natural disaster to safe havens as designated by the Department of State. Also called NEOs. (JP 3-68) See FM 3-07.

**noncontiguous area of operations** – Where one or more of the commander's subordinate forces' areas of operation do not share a common boundary. See also **area of operations**. (FM 3-90-1)

**nongovernmental organization** – (DOD) A private, self-governing, not-for-profit organization dedicated to alleviating human suffering; and/or promoting education, health care, economic development, environmental protection, human rights, and conflict resolution; and/or encouraging the establishment of democratic institutions and civil society. (JP 3-08) See ADRP 3-0, FM 3-07, FM 3-50.1, and ATP 3-57.20.

**nonstandard bridging** – Bridging that is purposely designed for a particular gap and typically built using commercial off-the-shelf or locally available materials. (ATTP 3-90.4)





- objective** – (DOD) The clearly defined, decisive, and attainable goal toward which every operation is directed. (JP 5-0) See ADRP 5-0. (Army) A location on the ground used to orient operations, phase operations, facilitate changes of direction, and provide for unity of effort. (ADRP 3-90)
- objective rally point** – A rally point established on an easily identifiable point on the ground where all elements of the infiltrating unit assemble and prepare to attack the objective. (ADRP 3-90)
- obscuration** – The employment of materials into the environment that degrade optical and/or electro-optical capabilities within select portions of the electromagnetic spectrum in order to deny acquisition by or deceive an enemy or adversary. (ADRP 1-02)
- observation** – The condition of weather and terrain that permits a force to see the friendly, enemy, and neutral personnel and systems, and key aspects of the environment. (ADRP 1-02)
- observation post** – A position from which military observations are made, or fire directed and adjusted, and which possesses appropriate communications. While aerial observers and sensors systems are extremely useful, those systems do not constitute aerial observation posts. Also called OP. (FM 3-90-2)
- obstacle** – (DOD) Any natural or man-made obstruction designed or employed to disrupt, fix, turn, or block the movement of an opposing force, and to impose additional losses in personnel, time, and equipment on the opposing force. (JP 3-15) See FM 3-90-1.
- obstacle belt** – (DOD) A brigade-level command and control measure, normally given graphically, to show where within an obstacle zone the ground tactical commander plans to limit friendly obstacle employment and focus the defense. (JP 3-15) See FM 3-90-1.
- obstacle control measures** – Specific measures that simplify the granting of obstacle-emplacing authority while providing obstacle control. (FM 3-90-1)
- obstacle groups** – One or more individual obstacles grouped to provide a specific obstacle effect. (FM 3-90-1)
- obstacle line** – A conceptual control measure used at battalion or brigade level to show placement intent without specifying a particular type of linear obstacle. (FM 90-7)
- obstacle restricted areas** – (DOD) A command and control measure used to limit the type or number of obstacles within an area. (JP 3-15) See FM 3-90-1.
- obstacle zone** – (DOD) A division-level command and control measure, normally done graphically, to designate specific land areas where lower echelons are allowed to employ tactical obstacles. (JP 3-15) See FM 3-90-1.
- occupy** – A tactical mission task that involves a force moving a friendly force into an area so that it can control that area. Both the force's movement to and occupation of the area occur without enemy opposition. (FM 3-90-1)
- offensive counterair** – (DOD) Offensive operations to destroy, disrupt, or neutralize enemy aircraft, missiles, launch platforms, and their supporting structures and systems both before and after launch, and as close to their source as possible. Also called OCA. (JP 3-01) See ATP 3-55.6.
- offensive fires** – Fires that preempt enemy actions. (FM 3-09)
- offensive task** – A task conducted to defeat and destroy enemy forces and seize terrain, resources, and population centers. (ADRP 3-0)
- on-call target** – (DOD) Planned target upon which fires or other actions are determined using deliberate targeting and triggered, when detected or located, using dynamic targeting. (JP 3-60) See ATP 3-60.1.
- on-order mission** – A mission to be executed at an unspecified time. (ATTP 5-0.1) See also **be-prepared mission**.
- open source** – Any person or group that provides information without the expectations of privacy – the Information, the relationship, or both is not protected against public disclosure. (ATP 2-22.9)

**open-source intelligence** – (DOD) Information of potential intelligence value that is available to the general public. Also called OSINT. (JP 2-0) See ATP 2-22.9 and ATP 3-05.20.

**operation** – (DOD) 2. A military action or the carrying out of a strategic, tactical, Service, training, or administrative military mission. (JP 3-0) See ADRP 3-90 and FM 3-90-1.

**operational approach** – (DOD) A description of broad actions the force must take to transform current conditions into those desired at end state. (JP 5-0) See ADRP 3-0, ADP 5-0, and ADRP 5-0.

**operational area** – (DOD) An overarching term encompassing more descriptive terms (such as area of responsibility and joint operations area) for geographic areas in which military operations are conducted. Also Called OA. (JP 3-0) See FM 3-07 and ATP 3-09.24.

**operational area security** – A form of security operations conducted to protect friendly forces, installations, routes, and actions within an area of operations. (ADRP 3-37)

**operational art** – (DOD) The cognitive approach by commanders and staffs—supported by their skill, knowledge, experience, creativity, and judgment—to develop strategies, campaigns, and operations to organize and employ military forces by integrating ends, ways, and means. (JP 3-0) See ADP 3-0, ADRP 3-0, and ADRP 5-0.

**operational contract support** – (DOD) The process of planning for and obtaining supplies, services, and construction from commercial sources in support of operations along with the associated contractor management functions. (JP 4-10) See ATTP 4-10.

**operational control** – (DOD) Command authority that may be exercised by commanders at any echelon at or below the level of combatant command. Operational control is inherent in combatant command (command authority) and may be delegated within the command. Operational control is the authority to perform those functions of command over subordinate forces involving organizing and employing commands and forces, assigning tasks, designating objectives, and giving authoritative direction necessary to accomplish the mission. Operational control includes authoritative direction over all aspects of military operations and joint training necessary to accomplish missions assigned to the command. Operational control should be exercised through the commanders of subordinate organizations. Normally this authority is exercised through subordinate joint force commanders and Service and/or functional component commanders. Operational control normally provides full authority to organize commands and forces and to employ those forces as the commander in operational control considers necessary to accomplish assigned missions; it does not, in and of itself, include authoritative direction for logistics or matters of administration, discipline, internal organization, or unit training. Also called OPCON. (JP 1) See ADRP 5-0.

**operational environment** – (DOD) A composite of the conditions, circumstances, and influences that affect the employment of capabilities and bear on the decisions of the commander. Also called OE. (JP 3-0) See ADRP 3-0, ADP 5-0, ADRP 6-0, FM 3-07, FM 3-57, ATP 3-55.6, and ATP 3-57.20.

**operational initiative** – The setting or dictating the terms of action throughout an operation. (ADRP 3-0)

**operational reach** – (DOD) The distance and duration across which a joint force can successfully employ military capabilities. (JP 3-0) See ADRP 3-0.

**operational training domain** – The training activities organizations undertake while at home station, at maneuver combat training centers, during joint exercises, at mobility centers, and while operationally deployed. (ADP 7-0)

**operation order** – (DOD) A directive issued by a commander to subordinate commanders for the purpose of effecting the coordinated execution of an operation. Also called OPORD. (JP 5-0) See ATP 3-57.20.

**operation plan** – (DOD) 1. Any plan for the conduct of military operations prepared in response to actual and potential contingencies. 2. A complete and detailed joint plan containing a full description of the concept of operations, all annexes applicable to the plan, and a time-phased force and deployment data. Also called OPLAN. (JP 5-0) See ATP 3-57.20.

**operations process** – The major mission command activities performed during operations: planning, preparing, executing and continuously assessing the operation. (ADP 5-0)

**operations security** – (DOD) A process of identifying critical information and subsequently analyzing friendly actions attendant to military operations and other activities. (JP 3-13.3) See ADRP 3-37 and ATP 3-05.20.

**organic** – (DOD) Assigned to and forming an essential part of military organization. Organic parts of a unit are those listed in its table of organization for the Army, Air Force, and Marine Corps, and are assigned to the administrative organizations of the operating forces for the Navy. (JP 1-02) See ADRP 5-0.

**other governmental agency** – (DOD) Within the context of interagency coordination, a non Department of Defense agency of the United States Government. (JP 1) See ADRP 3-0 and ATP 3-57.20.

**overbridging** – A method used to reinforce, provide emergency repair, or augment existing bridges or bridge spans using standard bridging. In close combat this is typically provided through the employment of tactical bridging. (ATTP 3-90.4)

**overt operation** – An operation conducted openly, without concealment. (ADRP 1-02)

—P—

**parallel planning** – Two or more echelons planning for the same operation through the sequential sharing of information from the higher headquarters prior to the headquarters publishing their operation plan or operation order. (ADRP 5-0)

**partner nation** – (DOD) Those nations that the United States works with to disrupt the production, transportation, distribution, and sale of illicit drugs, as well as the money involved with this illicit activity. Also called PN. (JP 3-07.4) See ATP 3-57.20.

**passage lane** – A lane through an enemy or friendly obstacle that provides a safe passage for a passing force. (FM 3-90-2)

**passage of lines** – (DOD) An operation in which a force moves forward or reward through another force's combat positions with the intention of moving into or out of contact with the enemy. (JP 3-18) See ADRP 3-90, FM 3-90-1 and FM 3-90-2.

**passage point** – A specifically designated place where the passing units will pass through the stationary unit. Also called PP. (FM 3-90-2) See also **passage of lines**.

**passive air defense** – (DOD) All measures other than active air defense, taken to minimize the effectiveness of hostile air and missile threats against friendly forces and assets. (JP 3-01) See ADRP 3-09, ADRP 3-90, and FM 3-90-1 and ATP 3-27.5.

**patient decontamination** – The removal and/or the neutralization of hazardous levels of chemical, biological, radiological and nuclear contamination from patients at a medical treatment facility. Patient decontamination is preformed under the supervision of medical personnel to prevent further injury to the patient and to maintain the patient's health status during the decontamination process. Patient decontamination serves multiple purposes; it protects the patient from further injury, it prevents exposing medical personnel to the contamination, and it prevents contamination of the medical treatment facility. (FM 4-02.7)

**peace building** – (DOD) Stability actions, predominately diplomatic and economic, that strengthen and rebuild governmental infrastructure and institutions in order to avoid a relapse into conflict. Also called PB. (JP 3-07.3) See ADRP 3-07 and ATP 3-07.5.

**peace enforcement** – (DOD) Application of military force, or threat of its use, normally pursuant to international authorization, to compel compliance with resolutions or sanctions designed to maintain or restore peace and order. (JP 3-07.3) See ADRP 3-07 and ATP 3-07.5.

**peacekeeping** – (DOD) Military operations undertaken with the consent of all major parties to a dispute, designed to monitor and facilitate implementation of an agreement (cease fire, truce, or other such agreement) and support diplomatic efforts to reach a long-term political settlement. (JP 3-07.3) See ADRP 3-07 and ATP 3-07.5.

**peacemaking** – (DOD) The process of diplomacy, mediation, negotiation, or other forms of peaceful settlements that arranges an end to a dispute and resolves issues that led to it. (JP 3-07.3) See ADRP 3-07, FM 3-07, and ATP 3-07.5.

**peace operations** – (DOD) A broad term that encompasses multiagency and multinational crisis response and limited contingency operations involving all instruments of national power with military missions to contain conflict, redress the peace, and shape the environment to support reconciliation and rebuilding and facilitate the transition to legitimate governance. Also called PO. (JP 3-07.3) See ADRP 3-07, FM 3-07, and ATP 3-07.5.

**penetration** – A form of maneuver in which an attacking force seeks to rupture enemy defenses on a narrow front to disrupt the defensive system. (FM 3-90-1)

**performance work statement** – (DOD) A statement of work for performance based acquisitions that describe the results in clear, specific, and objective terms with measurable outcomes. Also called PWS (JP 4-10) See ATP 1-06.2.

**permissive environment** – (DOD) Operational environment in which host country military and law enforcement agencies have control as well as the intent and capability to assist operations that a unit intends to conduct. (JP 3-0) See FM 3-57.

**persistent surveillance** – (DOD) A collection strategy that emphasizes the ability of some collection systems to linger on demand in an area to detect, locate, characterize, identify, track, target, and possibly provide battle damage assessment and retargeting in near or real-time. Persistent surveillance facilitates the prediction of an adversary's behavior and the formulation and execution of preemptive activities to deter or forestall anticipated adversary courses of action. (JP 2-0) See ATP 3-60.1.

**personal protective equipment** – (DOD) The equipment provided to shield or isolate a person from the chemical, physical, and thermal hazards that can be encountered at a hazardous materials incident. Personal protective equipment includes both personal protective clothing and respiratory protection. Also called PPE. (JP 3-11) See ATP 4-02.84.

**personnel accountability** – (Army) The by-name recording of specific data on individuals as they arrive and depart from units or theater transition points. Data includes information such as duty status, changes in duty status, changes in location, and grade changes. (ATP 1-0.2)

**personnel readiness management** – The Personnel readiness management is the distribution of Soldiers and Army civilians to command and organizations based on documented manpower requirements, authorizations, and predictive analysis in support of the commander's plans and priorities need to accomplish its mission. (ATP 1-0.2)

**personnel recovery** – (DOD) The sum of military, diplomatic, and civil efforts to prepare for and execute the recovery and reintegration of isolated personnel. Also called PR. (JP 3-50) See ATP 3-05.20 and ATP 3-55.6. (Army) The sum of military, diplomatic, and civil efforts to prevent isolation incidents and to return isolated persons to safety or friendly control. (FM 3-50.1)

**personnel recovery coordination cell** – (DOD) The primary joint force component organization responsible for coordinating and controlling component personnel recovery missions. (JP 3-50) See FM 3-50.1.

**personnel services** – Sustainment functions that man and fund the force, maintain Soldier and family readiness, promote the moral and ethical values of the nation, and enable the fighting qualities of the Army. (ADP 4-0)

**personnel support** – Personnel support encompasses the functions of moral, welfare, recreation, command interest programs, and band operations and contributes to unit readiness by promoting fitness, building moral and cohesion, enhancing quality of life, and by providing recreational, social, and other support services for Soldiers, Department of Defense civilians, and other personnel authorized to accompany the force. (ATP 1-0.2)

**phase** – (DOD) In joint operation planning, a definitive stage of an operation or campaign during which a large portion of the forces and capabilities are involved in similar or mutually supporting activities for a common

purpose. (JP 5-0) See FM 3-07. (Army) A planning and execution tool used to divide an operation in duration or activity. (ADRP 3-0)

**phase line** – (DOD) line utilized for control and coordination of military operations, usually an easily identified feature in the operational area. Also called PL. (JP 3-09) See FM 3-90-1 and ATP 3-20.15.

**P-hour (airborne operations)** – In airborne assault operations, the specific hour on D-day at which a parachute assault commences with the exit of the first Soldier from an aircraft over a designated drop zone. P-hour may or may not coincide with H-hour. (ATTP 5-0.1)

**physical security** – That part of the Army security system, based on threat analysis, concerned with procedures and physical measures designed to safeguard personnel, property, and operations; to prevent unauthorized access to equipment, facilities, materiel, and information; and to protect against espionage, terrorism, sabotage, damage, misuse, and theft. (ATTP 3-39.32)

**physical security inspection** – A formal, recorded assessment of the physical protective measures and security procedures that are implemented to protect unit and activity assets. (ATTP 3-39.32)

**physical security survey** – A formal recorded assessment of and installation's overall physical security program, including electronic security measures. (ATTP 3-39.32)

**piecemeal commitment** – The immediate employment of units in combat as they become available instead of waiting for larger aggregations of units to ensure mass, or The unsynchronized employment of available forces so that their combat power is not employed effectively. (ADRP 3-90) See also **combat power**.

**planned target** – (DOD) Target that is known to exist in the operational environment, upon which actions are planned using deliberate targeting, creating effects which support commander's objectives. There are two subcategories of planned targets: scheduled and on-call. (JP 3-60) See ATP 3-60.1.

**planning** – The art and science of understanding a situation, envisioning a desired future, and laying out effective ways of bringing that future about. (ADP 5-0)

**planning horizon** – A point in time commander use to focus the organization's planning efforts to shape future events. (ADRP 5-0) See also **planning**.

**planning requirements and assessing collection** – The task that analyzes requirements, evaluates available assets (internal and external), recommends to the operations staff taskings for information collection assets, submits requests for information for adjacent and higher collection support, and conducts an assessment of the effectiveness of the information collection plan. (ATTP 2-01)

**platoon** – A subdivision of a company or troop consisting of two or more squads or sections. (ADRP 3-90)

**point of breach** – The location at an obstacle where the creation of a lane is being attempted. (ATTP 3-90.4)

**point of departure** – The point where the unit crosses the line of departure and begins moving along a direction of attack. (ADRP 3-90) See also **line of departure**.

**point of penetration** – The location, identified on the ground, where the commander concentrates his efforts at the enemy's weakest point to seize a foothold on the farside objective. (ATTP 3-90.4)

**police intelligence operations** – A military police function, integrated within all military police operations, that supports the operations process through analysis, production, and dissemination of information collected as a result of police activities to enhance situational understanding, protection, civil control, and law enforcement. Also called PIO. (FM 3-39)

**policing** – The application of control measures within an area of operations to maintain law and order, safety, and other matters affecting the general welfare of the population. (FM 3-39)

**populace and resources control** – Operations which provide security for the populace, deny personnel and materiel to the enemy, mobilize population and materiel resources, and detect and reduce the effectiveness of enemy agents. Populace control measures include curfews, movement restrictions, travel permits, registration cards, and resettlement of civilians. Resource control measures include licensing, regulations or guidelines, checkpoints (for example, road blocks), ration controls, amnesty programs, and inspection of

facilities. Most military operations employ some type of populace and resources control measures. Also called PRC. (FM 3-57)

**port opening** – The ability to establish, initially operate and facilitate throughput for ports of debarkation to support unified land operations. (ADRP 4-0)

**position area for artillery** – An area assigned to an artillery unit where individual artillery systems can maneuver to increase their survivability. A position area for artillery is not an area of operations for the artillery unit occupying it. (FM 3-90-1)

**positive control** – (DOD) A method of airspace control that relies on positive identification, tracking, and direction of aircraft within an airspace, conducted with electronic means by an agency having the authority and responsibility therein. (JP 3-52) See ATP 3-06.1.

**postal operations** – Postal operations provide a network to process mail and provide postal service to Soldiers and other personnel authorized to receive postal entitlements. Processing mail involves receiving, separating, sorting, dispatching, and redirecting ordinary and accountable mail; completing international mail exchange; handling casualty and enemy prisoner of war mail; and screening for contaminated or suspicious mail. Postal services involve selling stamps, cashing and selling money orders, providing registered (including classified up to secret), insured and certified mail services, and processing postal claims and inquiries. (ATP 1-0.2)

**precision munition** – A munition that corrects for ballistic conditions using guidance and control up to the aimpoint or submunitions dispense with terminal accuracy less than the lethal radius of effects. (FM 3-09)

**precision smart munition** – A munition or submunition that autonomously searches for, detects, classifies, selects, and engages a target or targets. A precision smart munition has a limited target discrimination capability. (FM 3-09)

**preparation** – Those activities performed by units and Soldiers to improve their ability to execute an operation. (ADP 5-0)

**preparation of the environment** – (DOD) An umbrella term for operations and activities conducted by selectively trained special operations forces to develop an environment for potential future special operations. (JP 3-05) See ADP 3-05 and ADRP 3-05.

**presumptive identification** – The employment of technologies with limited specificity and sensitivity by general-purpose forces in a field environment to determine the presence of a chemical, biological, radiological, and/or nuclear hazard with a low level of confidence and degree of certainty necessary to support immediate tactical decisions. (ATP 3-11.37)

**primary position** – The position that covers the enemy's most likely avenue of approach into the area of operations. (ADRP 3-90) See also **alternate position; area of operations; avenue of approach; battle position; subsequent position; supplementary position.**

**priority intelligence requirement** – (DOD) An intelligence requirement, stated as a priority for intelligence support, that the commander and staff need to understand the adversary or other aspects of the operational environment. Also called PIR. (JP 2-01) See ADRP 2-0, ADRP 5-0, ATP 3-55.6, and FM 3-57.

**priority of fires** – The commander's guidance to his staff, subordinate commanders, fire support planners, and supporting agencies to organize and employ fire support in accordance with the relative importance of the unit's mission. (ADRP 3-09) See also **fire support.**

**priority of support** – A Priority set by the commander to ensure a subordinate unit has support in accordance with its relative importance to accomplishing the mission. (ADRP 5-0)

**private information** – Data, facts, instructions, or other material intended for or restricted to a particular person, group, or organization. (ATP 2-22.9)

**private sector** – (DOD) An umbrella term that may be applied in the United States and in foreign countries to any or all of the nonpublic or commercial individuals and businesses, specified nonprofit organizations, most of academia and other scholastic institutions, and selected nongovernmental organizations. (JP 3-57) See ATP 3-57.20.

**probable line of deployment** – A phase line that designates as the location where the commander intends to deploy the unit into assault formation before beginning the assault. Also called PLD. (ADRP 3-90) See also **phase line**.

**procedures** – (DOD) Standard, detailed steps that prescribe how to perform specific tasks. (CJCSM 5120.01) See ATP 3-90.90.

**Profession of Arms** – The uniformed members of the Army Profession. This category includes the Regular Army, Army National Guard, and Army Reserve. (ADRP 1)

**program of targets** – A number of planned targets of a similar nature that are planned for sequential attack. (FM 3-09)

**proof** – The verification that a lane is free of mines or explosive hazards and that the width and trafficability at the point of breach are suitable for the passing force. (ATTP 3-90.4)

**protection** – (DOD) 1. Preservation of the effectiveness and survivability of mission-related military and nonmilitary personnel, equipment, facilities, information, and infrastructure deployed or located within or outside the boundaries of a given operational area. (JP 3-0) See ADRP 3-37, ADRP 5-0, FM 1-04, and FM 3-07. 2. In space usage, active and passive defensive measures to ensure the United States and friendly space systems perform as designed by seeking to overcome an adversary's attempts to negate them and to minimize damage if negation is attempted. (JP 3-14) See FM 3-07.

**protection warfighting function** – The related tasks and systems that preserve the force so the commander can apply maximum combat power to accomplish the mission. (ADRP 3-0) See also **warfighting function**.

**prudent risk** – A deliberate exposure to potential injury or loss when the commander judges the outcome in terms of mission accomplishment as worth the cost. (ADP 6-0)

**publicly available information** – Data, facts, instructions, or other material published or broadcast for general public consumption; available on request to a member of the general public; lawfully seen or heard by any casual observer; or made available to a meeting open to the general public. (ATP 2-22.9)

**pursuit** – An offensive operation designed to catch or cut off a hostile force attempting to escape, with the aim of destroying it. (ADRP 3-90)

—Q—

**quartering party** – A group of unit representatives dispatched to a probable new site of operations in advance of the main body to secure, reconnoiter, and organize an area prior to the main body's arrival and occupation. (FM 3-90-2) See also **advance party**.

**quick response force** – (Army) A dedicated force on a base with adequate tactical mobility and fire support designated to defeat Level I and Level II threats and shape Level III threats until they can be defeated by a tactical combat force or other available response forces. (ATP 3-37.10)

—R—

**raid** – (DOD) An operation to temporarily seize an area in order to secure information, confuse an adversary, capture personnel or equipment, or to destroy a capability culminating with a planned withdrawal. (JP 3-0) See FM 3-90-1.

**rally point** – 1. An easily identifiable point on the ground at which aircrews and passengers can assemble and reorganize following an incident requiring a forced landing. 2. An easily identifiable point on the ground at which units can reassemble and reorganize if they become dispersed. Also called RP. (ADRP 1-02)

**range** – 1. The distance between any given point and an object or target. 2. Extent or distance limiting the operation or action of something, such as the range of an aircraft, ship, or gun. 3. The distance that can be covered over a hard surface by a ground vehicle, with its related payload, using the fuel in its tank and its cans normally carried as part of the ground vehicle equipment. 4. Area equipped for practice in shooting of targets. In this meaning, also called target range. (ADRP 1-02)

**Rangers** – (DOD) Rapidly deployable airborne light infantry organized and trained to conduct highly complex joint direct action operations in coordination with or in support of other special operations units of all Services. (JP 3-05) See ADP 3-05 and ADRP 3-05.

**reachback** – (DOD) The process of obtaining products, services, and applications, or forces, or equipment, or material from organizations that are not forward deployed. (JP 3-30) See FM 3-57.

**rear boundary** – A boundary that defines the rearward limits of a unit's area. It usually also defines the start of the next echelon's support area. (FM 3-90-1) See also **area of operations; boundary**.

**rear echelon** – This echelon contains those elements of the force that are not required in the objective area. (ADRP 1-02)

**rearward passage of lines** – Occurs when a unit passes through another unit's positions while moving away from the enemy. (ADRP 3-90) See also **forward passage of lines; passage of lines**.

**reclamation** – Regeneration or processing of a material to recover a usable product. Examples include the recovery of lead from spent batteries and the regeneration of spent solvents. (FM 3-34.5)

**reconnaissance** – (DOD) A mission undertaken to obtain, by visual observation or other detection methods, information about the activities and resources of an enemy or adversary, or to secure data concerning the meteorological, hydrographic or geographic characteristics of a particular area. Also called RECON. (JP 2-0) See ADRP 3-90, FM 3-90-2 and ATP 3-55.6.

**reconnaissance by fire** – A technique in which a unit fires on a suspected enemy position to cause the enemy forces to disclose their presence by movement or return fire. (FM 3-90-2)

**reconnaissance in force** – A deliberate combat operation designed to discover or test the enemy's strength, dispositions, and reactions or to obtain other information. (ADRP 3-90)

**reconnaissance objective** – A terrain feature, geographical area, enemy force, adversary, or other mission or operational variable, such as specific civil considerations, about which the commander wants to obtain additional information. (ADRP 3-90)

**reconnaissance-pull** – Reconnaissance that determines which routes are suitable for maneuver, where the enemy is strong and weak, and where gaps exist, thus pulling the main body toward and along the path of least resistance. This facilitates the commander's initiative and agility. (FM 3-90-2)

**reconnaissance-push** – Reconnaissance that refines the common operational picture, enabling the commander to finalize the plan and support shaping and decisive operations. It is normally used once the commander commits to a scheme of maneuver or course of action. (FM 3-90-2)

**reconnaissance squadron** – A unit consisting of two or more company, battery, or troopsize units and a headquarters. (ADRP 3-90)

**reconstitution** – Extraordinary actions that commanders plan and implement to restore units to a desired level of combat effectiveness commensurate with mission requirements and available resources. (ADRP 1-02) See also **regeneration; reorganization**.

**recovery force** – (DOD) In personnel recovery, an organization consisting of personnel and equipment with a mission of locating, supporting, and recovering isolated personnel, and returning them to friendly control. (JP 3-50) See FM 3-50.1.

**reduce** – 1. A tactical mission task that involves the destruction of an encircled or bypassed enemy force. (FM 3-90-1) 2. A mobility task to create and mark lanes through, over, or around an obstacle to allow the attacking force to accomplish its mission. (ATTP 3-90.4) See also **assault; bypass; destroy; neutralize; obscure; secure; suppress; tactical mission task**.

**reduction area** – A number of adjacent points of breach that are under the control of the breaching commander. (ATTP 3-90.4)

**redundancy** – Using two or more like assets to collect against the same intelligence requirement. (FM 3-90-2)



**refugee** – (DOD) A person who owing to a well-founded fear of being persecuted for reasons of race, religion, nationality, membership of a particular social group or political opinion, is outside the country of his or her nationality and is unable or, owing to such fear, is unwilling to avail himself or herself of the protection of that country. (JP 3-29) See FM 3-57 and FM 3-07.

**regeneration** – Rebuilding of a unit through large-scale replacement of personnel, equipment, and supplies, including the reestablishment or replacement of essential command and control and the conduct of mission-essential training for the newly rebuilt unit. (FM 100-9) See also **reconstitution**; **reorganization**.

**regional air defense commander** – (DOD) Commander, subordinate to the area air defense Commander, who is responsible for air and missile defense in the assigned region and exercises authorities as delegated by the area air defense commander. Also called RADC. (JP 3-01) See ATP 3-27.5.

**regionally aligned forces** – Those forces that provide a combatant commander with up to joint task force capable headquarters with scalable, tailorable capabilities to enable the combatant commander to shape the environment. They are those Army units assigned to combatant commands, those Army units allocated to a combatant command, and those Army capabilities distributed and prepared by the Army for combatant command regional missions. (FM 3-22)

**regional mechanism** – The primary method through which friendly forces affect indigenous populations, host nations, or the enemy to establish the conditions needed to safeguard our interests and those of our allies. (ADP 3-05)

**rehearsal** – A session in which a staff or unit practices expected actions to improve performance during execution. (ADRP 5-0)

**reinforcing** – A support relationship requiring a force to support another supporting unit. (ADRP 5-0)

**reintegrate** – (DOD) In personnel recovery, the task of conducting appropriate debriefings and reintegrating recovered isolated personnel back to duty and their family. (JP 3-50) See FM 3-50.1.

**reintegration** – The process through which former combatants, belligerents, and displaced civilians receive amnesty, reenter civil society, gain sustainable employment, and become contributing members of the local populace. (ADRP 3-07)

**relay** – A single transport mission completed in one trip and utilizes multiple vehicles without transferring the load. (ATP 4-11)

**release line** – Phase line used in river crossing operations that delineates a change in the headquarters controlling movement. Also called RL. (ADRP 1-02) See also **phase line**.

**release point** – A location on a route where marching elements are released from centralized control. Also called RP. (FM 3-90-2) See also **lane**; **march column**; **march serial**; **march unit**; **start point**.

**relief in place** – (DOD) An operation in which, by direction of higher authority, all or part of a unit is replaced in an area by the incoming unit and the responsibilities of the replaced elements for the mission and the assigned zone of operations are transferred to the incoming unit. (JP 3-07.3) See FM 3-90-2.

**religious advisement** – (DOD) The practice of informing the commander on the impact of religion on joint operations to include, but not limited to: worship, rituals, customs and practices of US military personnel, international forces, and the indigenous population. (JP 1-05) See ATP 1-05.03.

**reorganization** – All measures taken by the commander to maintain unit combat effectiveness or return it to a specified level of combat capability. See also **reconstitution**; **regeneration**. (FM 3-90-1)

**reserve** – (Army) That portion of a body of troops which is withheld from action at the beginning of an engagement, in order to be available for a decisive movement. (ADRP 3-90)

**resistance movement** – (DOD) An organization effort by some portion of the civil population of a country to resist the legally established government or an occupying power and to disrupt civil order and stability. (JP 3-05) See ADRP 3-05.

**resource management operations** – The execution of the resource management mission includes analyze resource requirements, ensure commanders are aware of existing resource implications in order for them to

make resource informed decisions, and then obtain the necessary funding that allows the commander to accomplish the overall unit mission. (FM 1-06)

**resources** – (DOD) The forces, materiel, and other assets or capabilities apportioned or allocated to the commander of a unified or specified command. (JP 1-02) See ATP 3-07.20.

**responsibility** – (DOD) The obligation to carry forward an assigned task to a successful conclusion. With responsibility goes authority to direct and take the necessary action to ensure success. (JP 1-02) See ADRP 6-0.

**responsiveness** – The ability to react to changing requirements and respond to meet the needs to maintain support. (ADP 4-0)

**restricted area** – Any area to which entry is subject to special restrictions or control for security reasons or to safeguard property or material. (ATTP 3-39.32)

**restricted target** – (DOD) A valid target that has specific restrictions placed on the actions authorized against it due to operational considerations. (JP 3-60) See ADRP 3-09.

**restricted target list** – (DOD) A list restricted to targets nominated by elements of the joint force and approved by the joint force commander. This list also includes restricted targets directed by higher authorities. (JP 3-60) See ADRP 3-09.

**restrictive fire area** – (DOD) An area in which specific restrictions are imposed and into which fires that exceed those restrictions will not be delivered without coordination with the establishing headquarters. Also called RFA. (JP 3-09) See FM 3-90-1.

**restrictive fire line** – (DOD) A line established between converging friendly surface forces that prohibits fires or their effects across that line. Also called RFL. See FM 3-09.

**retain** – A tactical mission task in which the commander ensures that a terrain feature controlled by a friendly force remains free of enemy occupation or use. (FM 3-90-1) See also **tactical mission task**.

**retention** – An Army program that ensures all Soldiers, regardless of the type of military operation, have access to career counseling and retention processing. Retention improves readiness of the force, assists in force alignment, and contributes to maintaining the Army end strength. (ATP 1-0.2)

**retirement** – A form of retrograde in which a force out of contact moves away from the enemy. (ADRP 3-90)

**retrograde** – (Army) 1. A defensive task that involves organized movement away from the enemy. (ADRP 3-90) 2. (Army) An Army logistics function of returning materiel from the owning or using unit back through the distribution system to the source of supply, directed ship-to location, or point of disposal. (ADRP 1-02)

**retrograde movement** – Any movement of a command to the rear, or away from the enemy. It may be focused by the enemy or may be made voluntarily. Such movements may be classified as a withdrawal, retirement, or delaying action. (FM 3-90-1)

**risk** – (DOD) Probability and severity of loss linked to hazards. (JP 5-0) See FM 5-19.

**risk assessment** – (DOD) The identification and assessment of hazards (first two steps of risk management process). Also called RA. (JP 3-07.2) See FM 5-19 and ATP 3-60.1.

**risk management** – (DOD) The process of identifying, assessing, and controlling risks arising from operational factors and making decisions that balance risk cost with mission benefits. Also called RM. (JP 3-0) See ADRP 5-0, FM 3-57, and ATP 3-60.1.

**route** – The prescribed course to be traveled from a specific point of origin to a specific destination. (FM 3-90-1)

**route reconnaissance** – A directed effort to obtain detailed information of a specified route and all terrain from which the enemy could influence movement along that route. (ADRP 3-90)

**rule of law** – A principle under which all persons, institutions, and entities, public and private, including the state itself, are accountable to laws that are publicly promulgated, equally enforced, and independently adjudicated, and that are consistent with international human rights principles. (FM 3-07)

**rules for the use of force** – (DOD) Directives issued to guide United States forces on the use of force during various operations. These directives may take the form of execute orders, deployment orders, memoranda of agreement, or plans. Also called RUF. (JP 3-28) See ADRP 3-0.

**rules of engagement** – (DOD) Directives issued by competent military authority that delineate the circumstances and limitations under which United States forces will initiate and/or continue combat engagement with other forces encountered. Also called ROE. (JP 1-04) See ADRP 3-0, ADRP 3-09, ADRP 3-05, ATP 3-60.1, FM 1-04, FM 3-07, and ATP 3-06.1.

**running estimate** – The continuous assessment of the current situation used to determine if the current operation is proceeding according to the commander's intent and if planned future operations are supportable. (ADP 5-0)

—S—

**safe area** – (DOD) A designated area in hostile territory that offers the evader or escapee a reasonable chance of avoiding capture and of surviving until he or she can be evacuated. (JP 3-50) See ADRP 3-05.

**scheme of fires** – The detailed, logical sequence of targets and fire support events to find and engage high-payoff targets to accomplish the supported commander's intent. (FM 3-09)

**science of control** – The systems and procedures used to improve the commander's understanding and support accomplishing missions. (ADP 6-0)

**science of tactics** – Encompasses the understanding of those military aspects of tactics—capabilities, techniques and procedures—that can be measured and codified. (ADRP 3-90)

**screen** – A security task that primarily provides early warning to the protected force. (ADRP 3-90) See also **concealment; flank guard; guard; security operations; sensor; surveillance.**

**search and attack** – A technique for conducting a movement to contact that shares many of the characteristics of an area security mission. (FM 3-90-1)

**section** – An Army unit smaller than a platoon and larger than a squad. (ADRP 3-90)

**sector air defense commander** – (DOD) Commander subordinate to an area/regional air defense commander, who is responsible for air and missile defense in the assigned sector and exercises authorities delegated by the area/regional air defense commander. Also called SADC. (JP 3-01) See ATP 3-27.5.

**sector of fire** – That area assigned to a unit, crew-served weapon, or an individual weapon within which it will engage targets as they appear in accordance with established engagement priorities. (FM 3-90-1)

**secure** – A tactical mission task that involves preventing a unit, facility, or geographical location from being damaged or destroyed as a result of enemy action. (FM 3-90-1) See also **assault; breach; denial measure; destroy; reduce; suppress; tactical mission task.**

**security area** – That area that begins at the forward area of the battlefield and extends as far to the front and flanks as security forces are deployed. Forces in the security area furnish information on the enemy and delay, deceive, and disrupt the enemy and conduct counterreconnaissance. (ADRP 3-90) See also **counterreconnaissance; delay; disrupt.**

**security assistance** – (DOD) Group of programs authorized by the Foreign Assistance Act of 1961, as amended, and the Arms Export Control Act of 1976, as amended, or other related status by which the United States provides defense articles, military training, and other defense-related services, by grant, loan, credit, or cash sales in furtherance of national policies and objectives. Security Assistance is an element of Security Cooperation Agency. Also called SA. (JP 3-22) See FM 3-57.

**security cooperation** – (DOD) All Department of Defense interactions with foreign defense establishments to build defense relationships that promote specific US security interests, develop allied and friendly military capabilities for self-defense and multinational operations, and provide US forces with peacetime and contingency access to a host nation. (JP 3-22) See ADRP 3-0 and ADRP 3-07.

**security force assistance** – (DOD) The Department of Defense activities that contribute to unified action by the U.S. Government to support the development of the capacity and capability of foreign security forces and their supporting institutions. Also called SFA. (JP 3-22) See ADRP 3-05, ADRP 3-07 and ATP 3-07.5. (Army) The unified action to generate, employ, and sustain local, host-nation, or regional security forces in support of legitimate authority. (FM 3-07)

**security operations** – Those operations undertaken by a commander to provide early and accurate warning of enemy operations, to provide the force being protected with time and maneuver space within which to react to the enemy, and to develop the situation to allow the commander to effectively use the protected force. (ADRP 3-90) See also **cover**; **guard**; **screen**.

**security procedural measures** – Physical security measures to counter risk factors that will periodically change over a period of time – such criminal, terrorist, and hostile threats. The procedures can usually be changed in a short time and involve manpower. (ATTP 3-39.32)

**security sector reform** – (Army) The set of policies, plans, programs, and activities that a government undertakes to improve the way it provides safety, security, and justice. (FM 3-07)

**seize** – (Army) A tactical mission task that involves taking possession of a designated area using overwhelming force. (FM 3-90-1) See also **contain**; **tactical mission task**.

**self-development training domain** – Planned, goal-oriented learning that reinforces and expands the depth and breadth of an individual's knowledge base, self-awareness, and situational awareness; compliments institutional and operational learning; enhances professional competence; and meets personal objectives. (ADP 7-0)

**sequel** – (DOD) The subsequent major operation or phase based on the possible outcomes (success, stalemate, or defeat) of the current major operation or phase. (JP 5-0) See FM 3-07.

**shaping operation** – An operation that establishes conditions for the decisive operation through effects on the enemy, other actors, and the terrain. (ADRP 3-0) See also **decisive operation**; **sustaining operation**.

**shuttle** – A single transport mission completed in repeated trips by the same vehicles between two points. (ATP 4-11)

**signal operating instructions** – (DOD) A series of orders issued for technical control and coordination of the signal communication activities of a command. (JP 6-0) See FM 6-02.53.

**signals intelligence** – (DOD) 1. A category of intelligence comprising either individually or in combination all communications intelligence, electronic intelligence, and foreign instrumentation signals intelligence, however transmitted. 2. Intelligence derived from communications, electronic, and foreign instrumentation signals. Also called SIGINT. (JP 2-0) See ATP 3-05.20.

**simplicity** – Relates to processes and procedures to minimize the complexity of sustainment. (ADP 4-0)

**single envelopment** – A form of maneuver that results from maneuvering around one assailable flank of a designated enemy force. (FM 3-90-1)

**situation template** – (DOD) A depiction of assumed adversary dispositions, based on that adversary's preferred method of operations and the impact of the operational environment if the adversary should adopt a particular course of action. (JP 2-01.3) See FM 2-01.3.

**situational understanding** – The product of applying analysis and judgment to relevant information to determine the relationship among the operational and mission variables to facilitate decisionmaking. (ADP 5-0)

**sociocultural factors** – (DOD) The social, cultural, and behavioral factors characterizing the relationships and activities of the population or a specific region or operational environment. (JP 2-01.3) See ADRP 3-05.

- Soldier and leader engagement** – Interpersonal interactions by Soldiers and leaders with audiences in an area of operations. (FM 3-13)
- space-based infrared system** – (DOD) A consolidated system for infrared space, air, and terrestrial surveillance and reconnaissance along with associated communication link, designed to meet missile defense, missile warning and intelligence, surveillance, and reconnaissance mission requirements. Also called SBIRS. (JP 3-01) See ATP 3-27.5.
- special forces** – (DOD) US Army forces organized, trained, and equipped to conduct special operations with an emphasis on unconventional warfare capabilities. Also called SF. (JP 3-05) See ADP 3-05.
- special operations** – (DOD) Operations requiring unique modes of employment, tactical techniques, equipment, and training often conducted in hostile, denied, or politically sensitive environments and characterized by one or more of the following: time sensitive, clandestine, low visibility, conducted with and/or through indigenous forces, requiring regional expertise, and/or a high degree of risk. Also called SO. (JP 3-05) See ADP 3-05, ADRP 3-05, FM 1-04, and FM 3-57.
- special operations command** – (DOD) A subordinate unified or other joint command established by a joint force commander to plan, coordinate, conduct, and support joint special operations within the joint force commander's assigned operational area. See also **special operations**. (JP 3-05) See ADP 3-05.
- special operations command and control element** – (DOD) A special operations element that is the focal point for the synchronization of special operations forces activities with conventional forces. Also called SOCCE. (JP 3-05) See ADRP 3-05.
- special operations forces** – (DOD) Those Active and Reserve Component forces of the Military Service designated by the Secretary of Defense and specifically organized, trained, and equipped to conduct and support special operations. Also called SOF. (JP 3-05.1) See ADP 3-05, ADRP 3-05, and ATP 3-57.20.
- special operations liaison element** – (DOD) A special operations liaison team provided by the joint force special operations component commander to the joint force air component commander (if designated) or appropriate Service component air command and control organization, to coordinate, deconflict, and integrate special operations air, surface, and subsurface operations with conventional air operations. Also called SOLE. (JP 3-05) See ADRP 3-05.
- special operations-peculiar** – (DOD) Equipment, material, supplies, and services required for special operations missions for which there is no Service-common requirement. Also called SO-peculiar. (JP 3-05) See ADRP 3-05.
- special operations task force** – A temporary or semipermanent grouping of Army special operations forces units under one commander and formed to carry out a specific operation or a continuing mission. Also called SOTF. (ADRP 3-05)
- special reconnaissance** – (DOD) Reconnaissance and surveillance actions conducted as a special operation in hostile, denied, or politically sensitive environments to collect or verify information of strategic or operational significance, employing military capabilities not normally found in conventional forces. (JP 3-05) See ADP 3-05, ADRP 3-05, ADRP 3-90, and FM 3-90-2.
- special warfare** – The execution of activities that involve a combination of lethal and nonlethal actions taken by a specially trained and educated force that has a deep understanding of cultures and foreign language, proficiency in small-unit tactics, and the ability to build and fight alongside indigenous combat formations in a permissive, uncertain, or hostile environment. (ADP 3-05)
- specified task** – (Army) A task specifically assigned to a unit by its higher headquarters. (ATTP 5-0.1) See also **essential task**; **implied task**.
- spoiling attack** – A tactical maneuver employed to seriously impair a hostile attack while the enemy is in the process of forming or assembling for an attack. (FM 3-90-1)
- spoke** – A portion of the distribution system that refers to the transportation mode operator's responsibility for scheduled delivery to a receiving unit. (ATP 4-11)
- squad** – A small military unit typically containing two or more fire teams. (ADRP 3-90)

**stability mechanism** – The primary method through which friendly forces affect civilians in order to attain conditions that support establishing a lasting, stable peace. (ADRP 3-0)

**stability operations**– (DOD) An overarching term encompassing various military missions, tasks, and activities conducted outside the United States in coordination with other instruments of national power to maintain or reestablish a safe and secure environment, provide essential governmental services, emergency infrastructure reconstruction, and humanitarian relief. (JP 3-0) See ADP 3-05, ADRP 3-37, FM 1-04, FM 3-07, and FM 3-57.

**stability tasks** – Tasks conducted as part of operations outside the United States in coordination with other instruments of national power to maintain or reestablish a safe and secure environment and provide essential governmental services, emergency infrastructure reconstruction, and humanitarian relief. (ADP 3-07)

**stabilization** – The process by which underlying tensions that might lead to resurgence in violence and a breakdown in the law and order are managed and reduced, while efforts are made to support preconditions for successful long-term development. (FM 3-07)

**staff section** – A group of staff members by area of expertise under a coordination, special, or personal staff officer. (ATTP 5-0.1)

**standard bridging** – Any bridging derived from manufactured bridge systems and components that are designed to be transportable, easily constructed, and reused. (ATTP 3-90.4)

**standard operating procedure** – (DOD) A set of instructions covering those features of operations which lend themselves to a definite or standardized procedure without loss of effectiveness. The procedure is applicable unless ordered otherwise. Also called SOP. (JP 1-02) See ATP 3-90.90.

**stewardship** – The responsibility of Army professionals to ensure the profession maintains its five essential characteristics now and into the future. (ADRP 1)

**strategic communication** – (DOD) Focused United States Government efforts to understand and engage key audiences to create, strengthen, or preserve conditions favorable for the advancement of United States Government interests, policies, and objectives through the use of coordinated programs, plans, themes, messages, and products synchronized with the actions of all instruments of national power. Also called SC. (JP 5-0) See ATP 3-55.12.

**start point** – A location on a route where the march elements fall under the control of a designated march commander. Also called SP. (FM 3-90-2)

**stay-behind operation** – An operation in which the commander leaves a unit in position to conduct a specified mission while the remainder of the forces withdraw or retire from an area. (FM 3-90-1)

**straggler control** – Operations conducted to regulate friendly forces who have become separated from their commands by events in the area of operations. (FM 3-39)

**strength reporting** – The numerical end product of the personnel accountability process to reflect the combat power of a unit. It is based on fill versus authorizations and drives Army readiness and personnel readiness management. Strength reporting is used to monitor unit strength, prioritize replacements, execute strength distribution, and make tactical and human resources support decisions. Strength reporting is conducted at each mission command level. (ATP 1-0.2)

**strike coordination and reconnaissance** – A mission flown for the purpose of detecting targets and coordinating or performing attack or reconnaissance on those targets. Also called SCAR. (JP 3-03) See ATP 3-55.6 and ATP 3-60.1.

**striking force** – A dedicated counterattack force in a mobile defense constituted with the bulk of available combat power. (ADRP 3-90) See also **mobile defense**.

**strong point** – A heavily fortified battle position tied to a natural or reinforcing obstacle to create an anchor for the defense or to deny the enemy decisive or key terrain. (ADRP 3-90) Also called SP. See also **battle position; mobile defense**.

**subsequent position** – A position that a unit expects to move to during the course of battle. (ADRP 3-90)

- subversion** – (DOD) Actions designated to undermine the military, economic, psychological, or political strength or morale of a governing authority. (JP 3-24) See ADRP 3-05.
- supplementary position** – A defensive position located within a unit’s assigned area of operations that provides the best sectors of fire and defensive terrain along an avenue of approach that is not the primary avenue along where the enemy is expected to attack. (ADRP 3-90) See also **alternate position; area of operations; avenue of approach; battle position; sector of fire**.
- supply** – The process of providing all items necessary to equip, maintain, and operate a military command. See also **classes of supply**. (ADRP 1-02)
- supply discipline** – Command responsibility to identify and redistribute excess materials, observe senior commander’s priorities, and ensure subordinates operate within the legal boundaries of the logistics system. (ADRP 1-02)
- supply point distribution** – A method of distributing supplies to the receiving unit at a supply point, railhead, or truckhead. (ATP 4-11)
- support** – (DOD) The action of a force that aids, protects, complements, or sustains another force in accordance with the directive requiring such action. 2. A unit that helps another unit in battle. 3. An element of a command that assists, protects, or supplies other forces in combat. (JP 1) See FM 3-07.
- support area** – In contiguous areas of operations, an area for any commander that extends from its rear boundary forward to the rear boundary of the next lower level of command. (ADRP 3-0)
- support bridging** – Bridges used to establish semipermanent or permanent support to planned movements and road networks. Normally used to replace tactical bridging when necessary. (ATTP 3-90.4)
- support by fire** – A tactical mission task in which a maneuver force moves to a position where it can engage the enemy by direct fire in support of another maneuvering force. (FM 3-90-1) See also **attack by fire; overwatch; tactical mission task**.
- support by fire position** – The general position from which a unit conducts the tactical mission task of support by fire. (ADRP 3-90)
- support to civil administration** – Assistance given by U.S. armed forces to stabilize or to continue the operations of the governing body or civil structure of a foreign country, whether by assisting an established government or by establishing military authority over an occupied population. Also called SCA. (FM 3-57)
- supported unit** – As related to contracted support, a supported unit is the organization that is the recipient, but not necessarily the requester of, contractor-provided support. (ATTP 4-10)
- supporting distance** – The distance between two units that can be traveled in time for one to come to the aid of the other and prevent its defeat by an enemy or ensure it regains control of a civil situation. (ADRP 3-0) See also **supporting range**.
- supporting effort** – A designated subordinate unit with a mission that supports the success of the main effort. (ADRP 3-0)
- supporting range** – The distance one unit may be geographically separated from a second unit yet remain within the maximum range of the second unit’s weapons systems. (ADRP 3-0) See also **supporting distance**.
- suppress** – A tactical mission task that results in temporary degradation of the performance of a force or weapons system below the level needed to accomplish the mission. (FM 3-90-1) See also **tactical mission task**.
- suppression of enemy air defenses** – (DOD) Activity that neutralizes, destroys, or temporarily degrades surface-based enemy air defenses by destructive and/or disruptive means. Also called SEAD. (JP 3-01) See ATP 3-55.6.
- surgical strike** – The execution of activities in a precise manner that employ special operations forces in hostile, denied, or politically sensitive environments to seize, destroy, capture, exploit, recover, or damage designated targets, or influence threats. (ADP 3-05)

**surveillance** – (DOD) The systematic observation of aerospace, surface or subsurface areas, places, persons, or things by visual, aural, electronic, photographic, or other means. (JP 3-0) See FM 3-55 and ATP 3-55.6.

**survivability** – (DOD) All aspects of protecting personnel, weapons, and supplies while simultaneously deceiving the enemy. (JP 3-34) See ADRP 3-90 and FM 3-90-1. (Army, Marine Corps) A quality or capability of military forces which permits them to avoid or withstand hostile actions or environmental conditions while retaining the ability to fulfill their primary mission. (ATP 3-37.34)

**survivability move** – A move that involves rapidly displacing a unit, command post, or facility in response to direct and indirect fires, the approach of an enemy unit, a natural phenomenon, or as a proactive measure based on intelligence, meteorological data, and risk analysis of enemy capabilities and intentions (including weapons of mass destruction). (ADRP 3-90)

**survivability operations** – (Army, Marine Corps) Those military activities that alter the physical environment to provide or improve cover, concealment, and camouflage. (ATP 3-37.34)

**sustaining operation** – An operation at any echelon that enables the decisive operation or shaping operations by generating and maintaining combat power. (ADRP 3-0) See also **decisive operation; shaping operation**.

**sustainment** – (Army) The provision of logistics, personnel services, and health service support necessary to maintain operations until successful mission completion. (ADP 4-0)

**sustainment preparation of the operational environment** – The analysis to determine infrastructure, environmental factors, and resources in the operational environment that will optimize or adversely impact friendly forces means for supporting and sustaining the commander's operations plan. (ADP 4-0)

**sustainment warfighting function** – The related tasks and systems that provide support and services to ensure freedom of action, extend operational reach, and prolong endurance. (ADRP 3-0) See also **warfighting function**.

**synchronization** – (DOD) 1. The arrangement of military actions in time, space, and purpose to produce maximum relative combat power at a decisive place and time (JP 2-0) See ADP 3-0 and ADRP 3-0. 2. In the intelligence context, application of intelligence sources and methods in concert with the operation plan to ensure intelligence requirements are answered in time to influence the decisions they support. (JP 2-0) See FM 3-07 and ATP 3-07.20.

**synchronization matrix** – A tool the staff uses to record the results of wargaming and helps them synchronize a course of action across time, space, and purpose in relationship to potential enemy and civil actions. (ATTP 5-0.1)

**system** – (DOD) A functionally, physically, and/or behaviorally related group of regularly interacting or interdependent elements; that group of elements forming a unified whole. (JP 3-0) See FM 3-07.

—T—

**tactical air control party** – (DOD) A subordinate operational component of a tactical air control system designed to provide air liaison to land forces and for the control of aircraft. Also called TACP. (JP 3-09.3) See FM 3-52.

**tactical bridging** – Bridges used for the immediate mobility support of combat maneuver forces in close combat. They are very often employed under the threat of direct or indirect fire and are intended to be used multiple times for short periods. (ATTP 3-90.4)

**tactical command post** – A facility containing a tailored portion of a unit headquarters designed to control portions of an operation for a limited time. (ATTP 5-0.1) See also **command post**.

**tactical control** – (DOD) Command authority over assigned or attached forces or commands, or military capability or forces made available for tasking, that is limited to the detailed direction and control of movements or maneuvers within the operational area necessary to accomplish missions or tasks assigned. Tactical control is inherent in operational control. Tactical control may be delegated to, and exercised at any level at or below the level of combatant command. Tactical control provides sufficient authority for



controlling and directing the application of force or tactical use of combat support assets within the assigned mission or task. Also called TACON. (JP 1) See ADRP 5-0.

**tactical level of war** – (DOD) The level of war at which battles and engagements are planned and executed to achieve military objectives assigned to tactical units or task forces. (JP 3-0) See ADP 3-90.

**tactical mission task** – The specific activity performed by a unit while executing a form of tactical operation or form of maneuver. It may be expressed in terms of either actions by a friendly force or effects on an enemy force. See also **mission statement; operation order**. (FM 3-90-1)

**tactical questioning** – (DOD) Direct questioning by any Department of Defense personnel of a captured or detained person to obtain time-sensitive tactical intelligence information, at or near the point of capture or detention and consistent with applicable law. (JP 3-63) See FM 2-91.6 and FM 1-04.

**tactical road march** – A rapid movement used to relocate units within an area of operations to prepare for combat operations. (ADRP 3-90) See also **area of operations**.

**tactics** – (DOD) The employment and ordered arrangement of forces in relation to each other. (CJCSM 5120.01) See ADP 3-90 and ADRP 3-90.

**target** – (DOD) 1. An entity or object considered for possible engagement or other action. See ADP 3-09 and ADRP 3-09. 2. In intelligence usage, a country, area, installation, agency, or person against which intelligence operations are directed. 3. An area designated and numbered for future firing. See FM 3-90-1. 4. In gunfire support usage, an impact burst that hits the target. (JP 3-60) See FM 3-60, ATP 3-07.20, and ATP 3-06.1.

**target acquisition** – (DOD) The detection, identification, and location of a target in sufficient detail to permit the effective employment of weapons. Also called TA. (JP 3-60) See ADRP 3-09 and ATP 3-55.6.

**target analysis** – (DOD) An examination of potential targets to determine military importance, priority of attack, and weapons required to obtain a desired level of damage or casualties. (JP 3-60) See ATP 3-55.6.

**target audience** – (DOD) An individual or group selected for influence. Also called TA (JP 3-60) See ATP 3-07.20.

**target identification** – The accurate and timely characterization of a detected object on that battlefield as friend, neutral, or enemy. This aspect of combat identification is time sensitive and directly supports a combatant's shoot or don't shoot decision for detected objects on the battlefield. (ADRP 1-02) See ADRP 3-37.

**target of opportunity** – (DOD) 1. A target identified too late, or not selected for action in time, to be included in deliberate targeting that, when detected or located, meets criteria specific to achieving objectives and is processed using dynamic targeting. 2. A target visible to a surface or air sensor or observer, which is within range of available weapons and against which fire has not been scheduled or requested. (JP 3-60) See ATP 3-60.1.

**target reference point** – An easily recognizable point on the ground (either natural or man-made) used to initiate, distribute, and control fires. Also called TRP. See also **engagement area; sector of fire**. (ADRP 1-02)

**targeted area of interest** – (DOD) The geographical area where high-value targets can be acquired and engaged by friendly forces. Not all target areas of interest will form part of the friendly course of action; only target areas of interest associated with high priority targets are of interest to the staff. These are identified during staff planning and wargaming. Target areas of interest differ from engagement areas in degree. Engagement areas plan for the use of all available weapons. Target areas of interest might be engaged by a single weapon. Also called TAI. (JP 2-01.3) See ATP 3-55.6. (Army) The geographical area or point along a mobility corridor where successful interdiction will cause the enemy to abandon a particular course of action or require the enemy to use specialized engineer support to continue. It is where the enemy force can be acquired and engaged by friendly forces. (ADRP 1-02) See also **high-payoff target; high-value target**.

**targeting** – (DOD) The process of selecting and prioritizing targets and matching the appropriate response to them, considering operational requirements and capabilities. (JP 3-0) See ADP 3-09, ADRP 3-09, ADRP 5-0, and ATP 3-55.6.

**task organization** – (Army) A temporary grouping of forces designed to accomplish a particular mission. (ADRP 5-0)

**task-organizing** – The act of designing an operating force, support staff, or sustainment package of specific size and composition to meet a unique task or mission. (ADRP 3-0)

**technical control** – The supervision of human intelligence, counterintelligence, and signals intelligence collection tactics, techniques, and procedures. Technical control does not interfere with tasking organic human intelligence, counterintelligence, and signals intelligence collection assets; it ensures adherence to existing policies or regulations by providing technical guidance for human intelligence, counterintelligence, and signals intelligence tasks within the information collection plan. (ATTP 2-01)

**technical intelligence** – (DOD) Intelligence derived from the collection, processing, analysis, and exploitation of data and information pertaining to foreign equipment and materiel for the purposes of preventing technological surprise, assessing foreign scientific and technical capabilities, and developing countermeasures designed to neutralize an adversary's technological advantages. Also called TECHINT. (JP 2-0) See ATP 3-05.20.

**techniques** – (DOD) Non-prescriptive ways or methods used to perform missions, functions, or task. (CJCSM 5120.01) See ADRP 3-0, ADRP 5-0, and ADRP 6-0.

**tempo** – The relative speed and rhythm of military operations over time with respect to the enemy. (ADRP 3-0)

**terminal operations** – (DOD) The reception, processing, and staging of passengers; the receipt, transit storage and marshalling of cargo; the loading and unloading of modes of transport conveyances; and the manifesting and forwarding of cargo and passengers to a destination. (JP 4-01.5) See ATP 4-11.

**terminal phase** – (DOD) That portion of the flight of a ballistic missile that begins when the warhead or payload reenters the atmosphere and ends when the warhead or payload detonates, release its submunitions, or impacts. (JP 3-01) See ATP 3-27.5.

**terrain analysis** – (Army) The study of the terrain's properties and how they change over time, with use, and under varying weather conditions. Terrain analysis starts with the collection, verification, processing, revision, and construction of source data. It requires the analysis of climatology (current and forecasted weather conditions), natural and man-made features, and enemy or friendly vehicle performance metrics. Terrain analysis is a technical process and requires the expertise of geospatial information technicians and geospatial engineers. (ATTP 3-34.80)

**terrain management** – The process of allocating terrain by establishing areas of operation, designating assembly areas, and specifying locations for units and activities to deconflict activities that might interfere with each other. (ADRP 5-0) See also **area of operations**.

**terrorism** – (DOD) The unlawful use of violence or threat of violence to instill fear and coerce governments or societies. Terrorism is often motivated by religious, political, or other ideological beliefs and committed in the pursuit of goals that are usually political. (JP 3-07.2) See FM 3-57.

**theater** – (DOD) The geographical area for which a commander of a geographic combatant command has been assigned responsibility. (JP 1) See ATP 3-57.20.

**theater closing** – The process of redeploying Army forces and equipment from a theater, the drawdown and removal or disposition of Army non-unit equipment and materiel, and the transition of materiel and facilities back to host nation or civil authorities. (ADP 4-0)

**theater distribution** – (DOD) The flow of equipment, personnel, and material within theater to meet the geographic combatant commander's mission. (JP 4-09) See ADRP 4-0.

**theater opening** – The ability to establish and operate ports of debarkation (air, sea, and rail), to establish a distribution system, and to facilitate throughput for the reception, staging, and onward movement of forces within a theater of operations. (ADP 4-0)

- theater special operations command** – (DOD) A subordinate unified command established by a combatant commander to plan, coordinate, conduct, and support joint special operations. (JP 3-05) See ADP 3-05 and ADRP 3-05.
- theater validation identification** – The employment of multiple independent, established protocols and technologies by scientific experts in the controlled environment of a fixed or mobile/transportable laboratory to characterize a chemical, biological, radiological, and/or nuclear hazard with a high level of confidence and degree of certainty necessary to support operational-level decisions. (ATP 3-11.37)
- threat** – Any combination of actors, entities, or forces that have the capability and intent to harm United States forces, United States national interests, or the homeland. (ADRP 3-0)
- throughput distribution** – A method of distribution which bypasses one or more intermediate supply echelons in the supply system to avoid multiple handling. (ATP 4-11)
- time of attack** – The moment the leading elements of the main body cross the line of departure or, in a night attack, the point of departure. (ADRP 3-90) See also **line of departure; point of departure**.
- time on target** – (DOD) The actual time at which munitions impact the target. Also called TOT. (JP 3-09.3) See FM 100-30.
- time-sensitive target** – (DOD) A joint force commander validated target or set of targets requiring immediate response because it is a highly lucrative, fleeting target of opportunity or is poses (or will soon pose) a danger to friendly forces. Also called TST. (JP 3-60) See ATP 3-60.1.
- token** – An electronic identification method used within a multi-node configured command and control, battle management, and communications suite to identify the lead server for transmission of track data. The token may be transferred between suites to maintain positive integrity of track data. The suite where the token resides is the only suite that may make changes to the AN/TPY-2 (FBM) system configuration. The token methodology also applies within a single node command and control, battle management, and communications suite, but the token remains within the single node. (ATP 3-27.5)
- track** – (DOD) 1. A series of related contacts displayed on a data display console or other display device. (JP 3-01) See ATP 3-27.5. 2. To display of record the successive positions of a moving object. (JP 3-01) See ATP 3-55.6 and ATP 3-27.5. 3. TO lock into a point of radiation and obtain guidance there from. 4. To keep a gun properly aimed, or to point continuously a target-locating instrument at a moving target. 5. The actual path of an aircraft above or a ship on the surface of the Earth. 6. One of the two endless belts of which a full-track or half-track vehicle runs. 7. A metal part forming a path of a moving object such as the track around the inside of a vehicle for moving a mounted machine gun. (JP 3-01) See ATP 3-27.5.
- traffic control post** – Manned post used to preclude interruption of traffic flow or movement along designated routes. It is used to support maneuver and mobility support operations when required to facilitate movement. Also called TCP. (FM 3-39)
- trail party** – The last march unit in a march column and normally consists of primarily maintenance elements in a mounted march. (FM 3-90-2) See also **march serial; march unit; maintenance collection point**.
- training and evaluation outline** – A summary document that provides information on collective training objectives, related individual training objectives, resource requirements, and applicable evaluation procedures for a type of organization. (ADRP 7-0)
- training objective** – A statement that describes the desired outcome of a training activity in the unit. (ADRP 7-0)
- transitional military authority** – A temporary military government exercising the functions of civil administration in the absence of a legitimate civil authority. (FM 3-07)
- transportation** – A logistics function: the movement of units, personnel, equipment, and supplies to support the concept of operations. Transportation incorporates military, commercial, and multinational assets. Transportation includes motor, rail, air, and water modes. Transportation nodes include motor, rail, air, and water terminal operations. Transportation also includes movement control and associated activities. (ADRP 1-02)

**traveling overwatch** – A movement technique used when contact with enemy forces is possible. The lead element and trailing element are separated by a short distance which varies with the terrain. The trailing element moves at variable speeds and may pause for short periods to overwatch the lead element. It keys its movement to terrain and the lead element. The trailing element over-watches at such a distance that, should the enemy engage the lead element, it will not prevent the trailing element from firing or moving to support the lead element. (FM 3-90-2)

**trigger line** – A phase line located on identifiable terrain that crosses the engagement area—used to initiate and mass fires into an engagement area at a predetermined range for all or like weapon systems. See also **engagement area; phase line**. (ADRP 1-02)

**troop** – A company-size unit in a cavalry organization. (ADRP 3-90)

**troop leading procedures** – A dynamic process used by small-unit leaders to analyze a mission, develop a plan, and prepare for an operation. (ADP 5-0)

**troop movement** – The movement of troops from one place to another by any available means. (ADRP 3-90)

**turn** – 1. A tactical mission task that involves forcing an enemy force from one avenue of approach or mobility corridor to another. 2. A tactical obstacle effect that integrates fire planning and obstacle effort to divert an enemy formation from one avenue of approach to an adjacent avenue of approach or into an engagement area. (FM 3-90-1) See also **avenue of approach; tactical mission task**.

**turning movement** – (Army) A form of maneuver in which the attacking force seeks to avoid the enemy's principle defensive positions by seizing objectives behind the enemy's current positions thereby causing the enemy force to move out of their current positions or divert mayor forces to meet the threat. (FM 3-90-1)

—U—

**unanticipated target** – (DOD) A target of opportunity that was unknown or not expected to exist in the operational environment. (JP 3-60) See ATP 3-60.1.

**unauthorized commitment** – (DOD) An agreement that is not binding solely because the United States Government representative who made it lacked the authority to enter into that agreement on behalf of the United States Government. (JP 4-10) See FM 1-04.

**uncertain environment** – (DOD) Operational environment in which host government forces, whether opposed to or receptive to operations that a unit intends to conduct, do not have totally effective control of the territory and population in the intended operational area. (JP 3-0) See FM 3-57.

**uncommitted force** – A force that is not in contact with an enemy and is not already deployed on a specific mission or course of action. (ADRP 3-90)

**unconventional warfare** – (DOD) Activities conducted to enable a resistance movement or insurgency to coerce, disrupt, or overthrow a government or occupying power by operating through or with an underground, auxiliary, and guerilla force in a denied area. Also called UW. (JP 3-05) See ADP 3-05, and ADRP 3-05.

**underground** – A cellular covert element within unconventional warfare that is compartmentalized and conducts covert or clandestine activities in areas normally denied to the auxiliary and the guerrilla force. (ADRP 3-05)

**unified action** – (DOD) The synchronization, coordination, and/or integration of the activities of governmental and nongovernmental entities with military operations to achieve unity of effort. (JP 1) See ADP 6-0, ADRP 3-0, ADRP 3-07, ADRP 3-28, ADRP 6-0, and FM 3-50.1.

**unified action partners** – Those military forces, governmental and nongovernmental organizations, and elements of the private sector with whom Army forces plan, coordinate, synchronize, and integrate during the conduct of operations. (ADRP 3-0)

**unified command** – (DOD) A command with a broad continuing mission under a single commander and composed of significant assigned components of two or more Military Departments that is established and

so designated by the President, through the Secretary of Defense with the advice and assistance of the Chairman of the Joint Chiefs of Staff. Also called unified combatant command. (JP 1) See FM 3-57.

**unified land operations** – How the Army seizes, retains, and exploits the initiative to gain and maintain a position or relative advantage in sustained land operations through simultaneous offensive, defensive, and stability operations in order to prevent or deter conflict, prevail in war, and create the conditions for favorable conflict resolution. (ADP 3-0)

**unit** – (DOD) Any military element whose structure is prescribed by competent authority, such as a table of organization and equipment; specifically, part of an organization. (JP 3-33) See chapter 4 of this publication.

**unit distribution** – A method of distributing supplies by which the receiving unit is issued supplies in its own area, with transportation furnished by the issuing agency. (ATP 4-11)

**unity of command** – (DOD) The operation of all forces under a single responsible commander who has the requisite authority to direct and employ those forces in pursuit of a common purpose. (JP 3-0) See ADP 6-0.

**unity of effort** – (DOD) Coordination, and cooperation toward common objectives, even if the participants are not necessarily part of the same command or organization—the product of successful unified action. (JP 1) See ADP 3-0, ADRP 3-0, ADP 6-0, ADRP 3-28, ADRP 6-0, and ATP 3-07.5.

**unplanned target** – (DOD) A target of opportunity that is known to exist in the operational environment. (JP 3-60) See ATP 3-60.1.

**urban operations** – Operations across the range of military operations planned and conducted on, or against objectives on a topographical complex and its adjacent natural terrain, where man-made construction or the density of population are the dominant features. (FM 3-06)

—V—

**validation** – (DOD) 1. A process associated with the collection and production of intelligence that confirms that an intelligence collection or production requirement is sufficiently important to justify the dedication of intelligence resources, does not duplicate an existing requirement, and has not been previously satisfied. 2. A part of target development that ensures all vetted targets meet the objectives and criteria outlined in the commander's guidance and ensures compliance with the law of war and rules of engagement. 3. In computer modeling and simulation, the process of determining the degree to which a model or simulation is an accurate representation of the real world from the perspective of the intended uses of the model or simulation. 4. Execution procedure whereby all the information records in a time-phased force and deployment data are confirmed error free and accurately reflect the current status, attributes, and availability of units and requirements. (JP 3-35) See ATP 3-60.1.

**vehicle distance** – The clearance between vehicles in a column which is measured from the rear of one vehicle to the front of the following vehicle. See also **march column; march serial; march unit**. (ADRP 1-02)

**vertical envelopment** – (DOD) A tactical maneuver in which troops that are air-dropped, air-land, or inserted via air assault, attack the rear and flanks of a force, in effect cutting off or encircling the force. (JP 3-18) See FM 3-90-1.

**vetting** – (DOD) A part of target development that assesses the accuracy of the supporting intelligence to targeting. (JP 3-60) See ATP 3-60.1.

**visual information** – (DOD) Various visual media with or without sound. Generally, visual information includes still and motion photography, audio video recording, graphic arts, visual aids, models, displays, and visual presentations. Also called VI. (JP 3-61) See ATP 3-55.12.

**vulnerabilities** – Characteristics, motives, or conditions of the target audience that can be used to influence behavior. (FM 3-53)

—W—

**waiting area** – A location adjacent to the route or axis that may be used for the concealment of vehicles, troops, and equipment while an element is waiting to resume movement. Waiting areas are normally located on both banks (or sides) close to crossing areas. (ATTP 3-90.4)

**warfighting function** – A group of tasks and systems (people, organizations, information, and processes), united by a common purpose that commanders use to accomplish missions and training objectives. (ADRP 3-0)

**wargaming** – A step-by-step process of action, reaction, and counteraction for visualizing the execution of each friendly course of action in relation to enemy courses of action and reactions. See also **branch; commander’s visualization; decision point; sequel**. (ADRP 1-02)

**weapon engagement zone** – (DOD) In air defense, airspace of defined dimensions within which the responsibility for engagement of air threats normally rests with a particular weapon system. Also called WEZ. (JP 3-01) See ATP 3-06.1.

**weapons of mass destruction** – (DOD) Chemical, biological, radiological. Or nuclear weapons capable of a high order of destruction or causing mass casualties and exclude the means of transporting or propelling the weapon where such means is a separable and divisible part from the weapon. Also called WMD. (JP 3-40) See ADRP 3-05.

**weapons of mass destruction counterforce** – A tactical objective to defeat the full range of chemical, biological, radiological, and nuclear threats before they can be employed as weapons. (FM 3-11)

**weapons of mass destruction proliferation prevention** – The employment of tactical level capabilities to support operational and strategic nonproliferation objectives of combating weapons of mass destruction. (FM 3-11)

**wide area security** – The application of the elements of combat power in unified action to protect populations, forces, infrastructure, and activities; to deny the enemy positions of advantage; and to consolidate gains in order to retain the initiative. (ADP 3-0)

**withdrawal operation** – (DOD) A planned retrograde operation in which a force in contact disengages from an enemy force and moves in a direction away from the enemy, (JP 1-02) See ADRP 3-90 and FM 3-90-1.

**working group** – (Army) A grouping of predetermined staff representatives who meet to provide analysis, coordinate, and provide recommendations for a particular purpose or function. (ATTP 5-0.1)

—Z—

**zone reconnaissance** – A form of reconnaissance that involves a directed effort to obtain detailed information on all routes, obstacles, terrain, and enemy forces within a zone defined by boundaries. (ADRP 3-90)

## Chapter 2

# Acronyms and Abbreviations

This chapter presents acronyms, abbreviations, and geographical entity codes.

### SECTION I — ACRONYMS AND ABBREVIATIONS

2-1. This section (pages 2-1 to 2-11) lists selected Army and joint acronyms and abbreviations commonly used in Army doctrine.

*Bolded entries apply only to the Army. An asterisk (\*) marks terms shown in chapter 1.*

—A—

<b>A</b>	<b>airborne</b>
<b>AA</b>	<b>assembly area</b>
AAMDC	Army air and missile defense command
AAP	Allied administrative publication
<b>ABF</b>	<b>attack by fire</b>
ABCA	American, British, Canadian, Australian, and New Zealand
<b>ABCT</b>	<b>armored brigade combat team</b>
ACM	airspace coordinating measure
ACT	*activity
<b>ACU</b>	<b>Army combat uniform</b>
<b>AD3E</b>	<b>asses, decide, develop and detect, deliver, and evaluate</b>
ADAM	air defense airspace management
<b>ADP</b>	<b>Army doctrine publication</b>
<b>ADRP</b>	<b>Army doctrine reference publication</b>
<b>ADSI</b>	<b>air defense systems integrator</b>
AELT	aeromedical evacuation liaison team
<b>AEP</b>	<b>allied engineering publication</b>
AGL	above ground level
<b>AHS</b>	<b>Army Health System</b>
<b>AGM</b>	<b>attack guidance matrix</b>
AIT	automated identification technology
<b>AKO</b>	<b>Army Knowledge Online</b>
<b>ALE</b>	<b>Army special operations forces liaison element</b>
AMC	<b>air mission commander</b> ; *airborne mission coordinator
<b>AMDWS</b>	<b>air and missile defense workstation</b>
AO	area of operations
AOR	*area of responsibility
<b>APC</b>	<b>armored personnel carrier</b>

**Italicized entries apply only to the Army. An asterisk (\*) marks terms shown in chapter 1.**

APP	allied procedural publication
<b>APKWS</b>	<b>advance precision kill weapon system</b>
APS	Army pre-positioned stocks
AR	Army regulation
<b>*ARFOR</b>	Army forces
<b>ARFORGEN</b>	<b>Army force generation</b>
<b>ARSOAC</b>	<b>Army Special Operations Aviation Command</b>
<b>ASB</b>	<b>aviation support battalion</b>
ASCC	Army Service component command
<b>ASR</b>	<b>*alternate supply route</b>
<b>ATCICA</b>	<b>Army theater counterintelligence coordinating authority</b>
<b>ATHP</b>	<b>*ammunition transfer holding point</b>
ATO	*air tasking order
<b>ATP</b>	<b>Army techniques publication</b>
ATTP	Army tactics, techniques, and procedures
<b>AUTL</b>	<b>Army Universal Task List</b>

—B—

<b>BCS3</b>	<b>Battle Command Sustainment Support System</b>
BDA	*battle damage assessment
<b>BDAR</b>	<b>battle damage assessment and repair</b>
<b>BFSB</b>	<b>battlefield surveillance brigade</b>
<b>BH</b>	<b>behavioral health</b>
<b>BHA</b>	<b>bomb hit assessment</b>
<b>BHL</b>	<b>*battle handover line</b>
<b>BHO</b>	<b>battle handover</b>
BIO	biological
BM	*battle management
<b>BMSO</b>	<b>brigade medical supply officer</b>
BSB	brigade support battalion
<b>BSMC</b>	<b>brigade support medical company</b>
<b>btry</b>	<b>battery</b>

—C—

C2	*command and control
CA	*civil administration
<b>CAB</b>	<b>civil affairs brigade; combined arms battalion; combat aviation brigade</b>
CACOM	civil affairs command
CAAF	contractor personnel authorized to accompany the force
<b>CAO</b>	<b>casualty assistance officer</b>
CAP	*crisis action planning
<b>CAPT</b>	<b>civil affairs planning team</b>



*Bolded entries apply only to the Army. An asterisk (\*) marks terms shown in chapter 1.*

CARVER	criticality, accessibility, recuperability, vulnerability, effect, and recognizability [a target assessment technique]
CASEVAC	*casualty evacuation
<b>CAT</b>	<b>civil affairs team</b>
<b>CATS</b>	<b>combined arms training strategy</b>
CBRN	chemical, biological, radiological, and nuclear
<b>CBRNWRS</b>	<b>chemical, biological, radiological, and nuclear warning and reporting system</b>
<b>CCA</b>	<b>close combat attack</b>
<b>CCD</b>	<b>charged-coupled device</b>
CCP	casualty collection point; <b>communications checkpoint; communications contingency package; contingency command post</b>
<b>CDRJSOTF</b>	<b>commander, joint special operations task force</b>
<b>CEMA</b>	<b>cyber electromagnetic activities</b>
<b>CFZ</b>	<b>critical friendly zone</b>
<b>chem</b>	<b>chemical</b>
CI	*counterintelligence; civil internee
CID	*combat identification
<b>CIG</b>	<b>civil information grid</b>
CIM	*civil information management
<b>CIVCAS</b>	<b>civilian casualty</b>
<b>CJA</b>	<b>command judge advocate</b>
<b>CJSOTF</b>	<b>combined joint special operations task force</b>
CLT	*civil liaison team
<b>CLS</b>	<b>combat lifesaver</b>
<b>CM</b>	<b>consequence management</b>
<b>CME</b>	* <b>civil-military engagement</b>
CMOC	*civil-military operations
<b>CMSE</b>	* <b>civil-military support element</b>
COCOM	*combatant command (command authority)
COF	chief of fires
COMCAM	*combat camera
COG	*center of gravity
<b>COIC</b>	<b>current operations intergration cell</b>
CP	*counterproliferation
<b>CR</b>	* <b>civil reconnaissance</b>
<b>CRM</b>	<b>composite risk management</b>
CRSP	centralized receiving and shipping point
CS	*civil support
CSAR	*combat search and rescue
CSB	contracting support brigade
CSC	component subordinate command
CSSB	combat sustainment support battalion

**Italicized entries apply only to the Army. An asterisk (\*) marks terms shown in chapter 1.**

CUL common-user logistics  
 CULT common-user land transportation

—D—

DA Department of the Army  
 DAFL directive authority for logistics  
**DA Pam Department of the Army pamphlet**  
 DCGS distributed common ground/surface system  
**DCGS-A Distributed Common Ground System—Army**  
 DFSCOORD deputy fire support coordinator  
 DDOC deployment distribution operations center (USTRANSCOM) [United States Transportation Command]  
**DMC distribution management center**  
 DOD Department of Defense  
 DODD Department of Defense directive  
 DOTMLPF doctrine, organization, training, materiel, leadership and education, personnel, and facilities [the force development domains]  
**DT dynamic targeting**  
 DZ \*drop zone

—E—

**EAC echelons above corps**  
 EC \*enemy combatant  
 ELINT \*electronic intelligence  
 EMP electromagnetic pulse  
 EOC emergency operations center  
 EOD explosive ordnance disposal  
 EPA \*evasion plan of action  
**EPLRS enhanced position location and reporting system**  
**ERP \*engineer regulating point**  
 ESC expeditionary sustainment command  
 ESF \*emergency support function

—F—

**FAAD forward area air defense**  
**FAH final attack heading**  
**FAIO field artillery intelligence officer**  
**FARE forward area refueling equipment**  
 FARP forward arming and refueling point  
**FBCB2 Force XXI Battle Command, brigade and below**  
 FC fires cell  
**FCL \*final coordination line**  
 FFA \*free-fire area

***Bolded entries apply only to the Army. An asterisk (\*) marks terms shown in chapter 1.***

FHA	*foreign humanitarian assistance
<b>FIB</b>	<b>fires brigade</b>
FID	*foreign internal defense
FLIR	*forward-looking infrared
FM	field manual
FMC	<b>financial management center; field medical card</b> ; full mission-capable
FMT	field maintenance team
<b>FPL</b>	<b>*final protective line</b>
FRAGORD	*fragmentary order
<b>FS</b>	<b>fire support</b>
<b>FSC</b>	<b>forward support company</b>

—G—

<b>G-1</b>	<b>assistant chief of staff, personnel</b>
<b>G-2</b>	<b>assistant chief of staff, intelligence</b>
<b>G-2X</b>	<b>counterintelligence and human intelligence staff officer for a general staff</b>
G-3	assistant chief of staff, operations
G-4	assistant chief of staff, logistics
G-5	assistant chief of staff, plans
<b>G-6</b>	<b>assistant chief of staff, signal</b>
<b>G-7</b>	<b>assistant chief of staff, inform and influence activities</b>
<b>G-8</b>	<b>assistant chief of staff, financial management</b>
<b>G-9</b>	<b>assistant chief of staff, civil affairs operations</b>
<b>GCSS–Army (F/T)</b>	<b>Global Combat Support System–Army (field/tactical)</b>
GEOINT	*geospatial intelligence
GBMD	*global-based missile defense
GMD	*ground-based midcourse defense
<b>GSB</b>	<b>group support battalion</b>

—H—

HACC	*humanitarian assistance coordination center
HCA	*humanitarian and civic assistance
<b>HHB</b>	<b>headquarters and headquarters battery [field artillery and air defense artillery]</b>
HN	*host nation
HNS	*host nation support
<b>HPTL</b>	<b>high-payoff target list</b>
HRP	*high-risk personnel
<b>HRSC</b>	<b>human resources sustainment center</b>
HS	*homeland security
HSS	*health service support

**Bolded entries apply only to the Army. An asterisk (\*) marks terms shown in chapter 1.**

HUMINT	*human intelligence
HVAA	*high-value airborne asset protection
— —	
IAMD	*integrated air and missile defense
<b>IBS</b>	<b>integrated broadband system</b>
ICS	*incident command system
<b>ID</b>	<b>infantry division</b>
IDAD	*internal defense and development
<b>IDN</b>	<b>initial distribution number</b>
IED	improvised explosive device
IEM	installation emergency management
<b>IIA</b>	<b>inform and influence activities</b>
IMINT	*imagery intelligence
IO	*information operations
<b>IP</b>	<b>initial position</b>
IPB	<b>*intelligence preparation of the battlefield;</b> *intelligence preparation of the battlespace
IPE	*individual protective equipment
IPI	*indigenous populations and institutions
<b>IPERMS</b>	<b>Interactive Personnel Electronic Records Management System</b>
ISOPREP	*isolated personnel report
ITV	*in-transit visibility
IW	*irregular warfare
—J—	
J-2X	joint force counterintelligence and human intelligence staff element
JDDOC	joint deployment and distribution operations center
JEM	joint effects model
JFSOACC	*joint special operations air component commander
JFSOCC	*joint force special operations component commander
JIPOE	*joint intelligence preparation of the operational environment
<b>JIIM</b>	<b>joint, interagency, intergovernmental, multinational</b>
<b>JLENS</b>	<b>joint land attack cruise missile elevated netted sensor</b>
JLOTS	joint logistics over-the-shore
JP	joint publication
JPRC	*joint personnel recovery center
<b>JSLIST</b>	<b>joint service lightweight integrated suit technology</b>
JSOTF	*joint special operations task force
JTF	*joint task force

*Bolded entries apply only to the Army. An asterisk (\*) marks terms shown in chapter 1.*

## —L—

L	lewisite
lbs	pounds
LC	line of contact
LC/LA	low-cost and low-altitude
LD/LC	line of departure is line of contact
LL	*light line
LOA	*limit of advance, line of accounting
LOB	line of bearing
LOC	*line of communications
LOGCAP	logistics civil augmentation program
LOGPAC	*logistics package
LOGSA	logistics support activity
LOTS	logistics over-the-shore
LP/OP	listening post or observation post
LRP	logistics release point
LRS	long-range surveillance
LTIOV	latest time information is of value
LTL	laser-to-target line
LZ	*landing zone

## —M—

m	meter(s)
MASINT	*measurement and signature intelligence
MBA	main battle area
MCP	*maintenance collection point
MDMP	*military decisionmaking process
MEB	maneuver enhancement brigade
MEDBDE	medical brigade
METT-TC	mission, enemy, terrain and weather, troops and support available, time available, and civil considerations [mission variables]
MFF	military free fall
MHS	Military Health System
MILCON	military construction
MIL-STD	military standard
MIS	military information support
MISOC	military information support operations command
MLC	medical logistics company
mm	millimeter(s)
MMB	medical battalion (multifunctional)
MOPP	mission-oriented protective posture
MPAT	military information support planning and advisory team

*Bolded entries apply only to the Army. An asterisk (\*) marks terms shown in chapter 1.*

<b>MRAP</b>	<b>mine resistant ambush protected</b>
<b>MRL</b>	<b>multiple rocket launcher</b>
<b>MSL</b>	<b>mean sea level</b>
MSR	*main supply route
<b>MST</b>	<b>maintenance support team</b>

—N—

<b>NAAK</b>	<b>nerve agent antidote kit</b>
NAF	*nonappropriated funds
NAI	named area of interest
NATO	North Atlantic Treaty Organization
NDS	*national defense strategy
NEOs	*noncombat evacuation operations
<b>NETCOM</b>	<b>network command</b>
NFA	no-fire area
<b>NFL</b>	<b>no-fire line</b>
NGO	nongovernmental organization
<b>NGR</b>	<b>National Guard regulation</b>
NIMS	*National Incident Management System
NMS	*national military strategy
NSL	*no-strike list
NSS	*national security strategy
NVD	*night vision device
NVG	*night vision goggle(s)

—O—

OA	*operational area
<b>OAKOC</b>	<b>observation and fields of fire, avenues of approach, key terrain, obstacles, and cover and concealment [military aspects of terrain]</b>
OCA	*offensive counterair
<b>O/O</b>	<b>on order</b>
<b>OP</b>	<b>observation post</b>
OPLAN	*operation plan
OPORD	*operation order
OPSEC	*operations security
<b>ORF</b>	<b>*operational readiness float</b>
<b>OSHA</b>	<b>Occupational Safety and Health Administration</b>
OSINT	*open-source intelligence
<b>OTL</b>	<b>observer-target line</b>

*Bolded entries apply only to the Army. An asterisk (\*) marks terms shown in chapter 1.*

## —P—

PA	public affairs; physician assistant
PB	*peace building
<b>PBUSE</b>	<b>property book unit supply enhanced</b>
<b>PCC</b>	<b>precombat check</b>
<b>PCI</b>	<b>precombat inspection</b>
<b>PIO</b>	<b>*police intelligence operations</b>
PIR	priority intelligence requirement
<b>PLD</b>	<b>*probable line of deployment</b>
<b>PM</b>	<b>project manager</b>
<b>PMCS</b>	<b>preventive maintenance checks and services</b>
<b>PMESII-PT</b>	<b>political, military, economic, social, information, infrastructure, physical environment, and time [operational variables]</b>
PN	*partner nation
PO	<b>psychological objective</b> ; *peace operations
<b>PPO</b>	<b>project purchasing officer</b>
PPE	*personal protective equipment
PWS	*performance work statement

## —R—

<b>R</b>	<b>reinforcing</b>
<b>RAD</b>	<b>radiation absorbed dose</b>
RADC	*regional air defense commander
<b>RCT</b>	<b>regimental combat team</b>
RECON	*reconnaissance
<b>RDSP</b>	<b>rapid decisionmaking and synchronization process</b>
RFI	request for information
<b>RL</b>	<b>*release line</b>
<b>ROM</b>	<b>refuel-on-the-move</b>
<b>RP</b>	<b>*rally point, red phosphorus</b>
<b>RV</b>	<b>radius of vulnerability [nuclear]</b>

## —S—

<b>S-1</b>	<b>battalion or brigade personnel staff officer</b>
S-2	battalion or brigade intelligence staff officer
<b>S-2X</b>	<b>battalion or brigade counterintelligence and human intelligence staff officer</b>
S-3	battalion or brigade operations staff officer
S-4	battalion or brigade logistics staff officer
<b>S-5</b>	<b>battalion or brigade plans staff officer</b>
<b>S-6</b>	<b>battalion or brigade signal staff officer</b>
<b>S-7</b>	<b>battalion or brigade inform and influence activities staff officer</b>

*Bolded entries apply only to the Army. An asterisk (\*) marks terms shown in chapter 1.*

<b>S-8</b>	<b>battalion or brigade financial management staff officer</b>
<b>S-9</b>	<b>battalion or brigade civil affairs operations staff officer</b>
SA	*security assistance
SADC	*sector air defense commander
<b>SALT</b>	<b>size, activity, location, time</b>
<b>SAO</b>	<b>security assistance organization</b>
<b>SB (SO) (A)</b>	<b>sustainment brigade (special operations) (airborne)</b>
SBIRS	*space-based infrared system
SC	*strategic communication
SCA	support to civil administration
SEAD	*suppression of enemy air defenses
sec	second
SF	*special forces
<b>SFC</b>	<b>special forces command</b>
SIGINT	*signals intelligence
SO	*special operations
<b>SOAR</b>	<b>special operations aviation regiment</b>
SOCCE	*special operations command and control
<b>SP</b>	<b>*start point; strong point</b>
SOF	*special operations forces
SOLE	*special operations liaison element
SO-peculiar	*special operations-peculiar
SOP	*standard operating procedure
<b>SOT-A</b>	<b>special operations team A</b>
<b>SPO</b>	<b>support operations</b>
<b>STAMIS</b>	<b>standard Army management information system</b>
STANAG	standardization agreement
<b>STB</b>	<b>special troops battalion</b>
<b>STRIKWARN</b>	<b>strike warning</b>
<b>sust</b>	<b>sustainment</b>

—T—

TA	*target acquisition
<b>TAB</b>	<b>target acquisition battery; theater aviation brigade</b>
<b>TB MED</b>	<b>technical bulletin (medical)</b>
<b>TAV</b>	<b>total asset visibility</b>
<b>TC</b>	<b>training circular</b>
<b>TCAE</b>	<b>technical control and analysis element</b>
<b>TCP</b>	<b>*traffic control post</b>
TECHINT	*technical intelligence
TF	task force
<b>TG</b>	<b>technical guide</b>
<b>TGP</b>	<b>targeting pod</b>



**Italicized entries apply only to the Army. An asterisk (\*) marks terms shown in chapter 1.**

TGT	target
THAAD	terminal high-altitude area defense
TIB	toxic industrial biological
TIC	toxic industrial chemical
<b>TLP</b>	<b>troop leading procedures</b>
TRP	target reference point
TSC	theater sustainment command
TSCP	theater security cooperation plan
<b>TSM</b>	<b>target synchronization matrix</b>
TST	*time-sensitive target

—U—

<b>UCL</b>	<b>unit-configured load</b>
<b>UH</b>	<b>Utility helicopter</b>
<b>U.S.</b>	<b>United States</b>
UW	*unconventional warfare

—V—

VI	*visual information
<b>VoIP</b>	<b>voice-over-internet phone</b>
<b>VOIED</b>	<b>victim-operated improvised explosive device</b>

—W—

WEZ	*weapon engagement zone
WMD	*weapons of mass destruction

## SECTION II — GEOGRAPHICAL ENTITY CODES

2-2. On 19 February 2004, NATO Standardization Agreement (STANAG) 1059 (Edition. 8), *Letter Codes for Geographical Entities*, was promulgated. The aim of this agreement is to provide unique three-letter codes for use within NATO to distinguish geographical entities. However, due to implementation difficulties, a 28 January 2005 memorandum from the NATO Standardization Agency declared that until STANAG 1059 could be fully implemented, the two-letter code would be used for the technical automated information system domain, while in all other (nontechnical) administrative areas, the three-letter code would be used. The list on pages 2-12 to 2-18 provides both the two-letter and three-letter codes.

<i>Geographical entity</i>	<i>Two-letter code</i>	<i>Three-letter code</i>
<b>—A—</b>		
Afghanistan	AF	AFG
Albania	AL	ALB
Algeria	DZ	DZA
American Samoa	AS	ASM
Andorra	AD	AND
Angola	AO	AGO
Anguilla	AI	AIA
Antarctica	AQ	ATA
Antigua and Barbuda	AG	ATG
Argentina	AR	ARG
Armenia	AM	ARM
Aruba	AW	ABW
Australia	AU	AUS
Austria	AT	AUT
Azerbaijan	AZ	AZE
<b>—B—</b>		
Bahamas	BS	BHS
Bahrain	BH	BHR
Bangladesh	BD	BGD
Barbados	BB	BRB
Belarus	BY	BLR
Belize	BZ	BLZ
Belgium	BE	BEL
Benin	BJ	BEN
Bermuda	BM	BMU
Bhutan	BT	BTN
Bolivia	BO	BOL
Bosnia and Herzegovina	BA	BIH
Botswana	BW	BWA
Bouvet Island	BV	BVT
Brazil	BR	BRA
British Indian Ocean Territory	IO	IOT
Brunei Darussalam	BN	BRN
Bulgaria	BG	BGR
Burkina Faso	BF	BFA
Burundi	BI	BDI
<b>—C—</b>		
Cambodia	KH	KHM
Cameroon	CM	CMR

<i>Geographical entity</i>	<i>Two-letter code</i>	<i>Three-letter code</i>
Canada	CA	CAN
Cape Verde	CV	CPV
Cayman Islands	KY	CYM
Central African Republic	CF	CAF
Chad	TD	TCD
Chile	CL	CHL
China	CN	CHN
Christmas Island	CX	CXR
Cocos (Keeling) Islands	CC	CCK
Colombia	CO	COL
Comoros	KM	COM
Congo	CG	COG
Congo, The Democratic Republic of the	CD	COD
Cook Islands	CK	COK
Costa Rica	CR	CRI
Cote d'Ivoire (Ivory Coast)	CI	CIV
Croatia (Hrvatska)	HR	HRV
Cuba	CU	CUB
Cyprus	CY	CYP
Czech Republic	CZ	CZE
—D—		
Denmark	DK	DNK
Djibouti	DJ	DJI
Dominica	DM	DMA
Dominican Republic	DO	DOM
—E—		
Ecuador	EC	ECU
El Salvador	SV	SLV
Egypt	EG	EGY
Equatorial Guinea	GQ	GNQ
Eritrea	ER	ERI
Estonia	EE	EST
Ethiopia	ET	ETH
—F—		
Falkland Islands (Malvinas)	FK	FLK
Faroe Islands	FO	FRO
Fiji	FJ	FJI
Finland	FI	FIN
France	FR	FRA
French Guiana	GF	GUF

<i>Geographical entity</i>	<i>Two-letter code</i>	<i>Three-letter code</i>
French Polynesia	PF	PYF
French Southern Territories	TF	ATF
<b>—G—</b>		
Gabon	GA	GAB
Gambia	GM	GMB
Georgia	GE	GEO
Germany	DE	DEU
Ghana	GH	GHA
Gibraltar	GI	GIB
Greece	GR	GRC
Greenland	GL	GRL
Grenada	GD	GRD
Guadaloupe	GP	GLP
Guam	GU	GUM
Guatamala	GT	GTM
Guinea	GN	GIN
Guinea–Bissau	GW	GNB
Guyana	GY	GUY
<b>—H—</b>		
Haiti	HT	HTI
Heard Island and McDonald Islands	HM	HMD
Holy See (Vatican City State)	VA	VAT
Honduras	HN	HND
Hong Kong	HK	HKG
Hungary	HU	HUN
<b>—I—</b>		
Iceland	IS	ISL
India	IN	IND
Indonesia	ID	IDN
Iran, Islamic Republic of	IR	IRN
Iraq	IQ	IRQ
Ireland	IE	IRL
Israel	IL	ISL
Italy	IT	ITA
<b>—J—</b>		
Jamaica	JM	JAM
Japan	JP	JPN
Jordan	JO	JOR

<i>Geographical entity</i>	<i>Two-letter code</i>	<i>Three-letter code</i>
<b>—K—</b>		
Kazakhstan	KZ	KAZ
Kenya	KE	KEN
Kiribati	KI	KIR
Korea, Democratic People's Republic of	KP	PRK
Korea, Republic of	KR	KOR
Kuwait	KW	KWT
Kyrgyzstan	KG	KGZ
<b>—L—</b>		
Lao People's Democratic Republic	LA	LAO
Latvia	LV	LVA
Lebanon	LB	LBN
Lesotho	LS	LSO
Liberia	LR	LBR
Libyan Arab Jamahiriya	LY	LBY
Liechtenstein	LI	LIE
Lithuania	LT	LTU
Luxembourg	LU	LUX
<b>—M—</b>		
Macao	MO	MAC
Madagascar	MD	MDG
Malawi	MW	MWI
Malaysia	MY	MYS
Maldives	MV	MDV
Mali	ML	MLI
Malta	MT	MLT
Martinique	MQ	MTQ
Mauritania	MR	MRT
Mauritius	MU	MUS
Mexico	MX	MEX
Micronesia, Federated States of	FM	FSM
Moldova, Republic of	MD	MDA
Monoco	MC	MCO
Mongolia	MN	MNG
Montserrat	MS	MSR
Morocco	MA	MAR
Mozambique	MZ	MOZ
Myanmar	MM	MMR

<i>Geographical entity</i>	<i>Two-letter code</i>	<i>Three-letter code</i>
<b>—N—</b>		
Namibia	NA	NAM
Nauru	NR	NRU
Nepal	NP	NPL
Netherlands	NL	NLD
Netherlands Antilles	AN	ANT
New Caledonia	NC	NCL
New Zealand	NZ	NZL
Nicaragua	NI	NIC
Niger	NE	NER
Nigeria	NG	NGA
Niue	NU	NIU
Norfolk Island	NF	NFK
Northern Mariana Islands	MP	MNP
Norway	NO	NOR
<b>—O—</b>		
Oman	OM	OMN
<b>—P—</b>		
Pakistan	PK	PAK
Palau	PW	PLW
Panama	PA	PAN
Papua New Guinea	PG	PNG
Paraguay	PY	PRY
Peru	PE	PER
Philippines	PH	PHL
Pitcairn	PN	PCN
Poland	PL	POL
Portugal	PT	PRT
Puerto Rico	PR	PRI
<b>—Q—</b>		
Qatar	QA	QAT
<b>—R—</b>		
Reunion	RE	REU
Romania	RO	ROU
Russian Federation	RU	RUS
Rwanda	RW	RWA

<i>Geographical entity</i>	<i>Two-letter code</i>	<i>Three-letter code</i>
<b>—S—</b>		
Saint Helena	SH	SHL
Saint Kitts and Nevis	KN	KNA
Saint Lucia	LC	LCA
Saint Pierre and Miquelone	PM	SPM
Saint Vincent and the Grenadines	VC	VCT
Samoa	WS	WSM
San Marino	SM	SMR
Sao Tome and Principe	ST	STP
Saudi Arabia	SA	SAU
Senegal	SN	SEN
Serbia and Montenegro	CS	SCG
Seychelles	SC	SYC
Sierra Leone	SL	SLE
Singapore	SG	SGP
Slovakia	SK	SVK
Slovenia	SI	SVN
Solomon Islands	SB	SLB
Somalia	SO	SOM
South Africa	ZA	ZAF
South Georgia and South Sandwich Islands	GS	SGS
Spain	ES	ESP
Sri Lanka	LK	LKA
Sudan	SD	SDN
Suriname	SR	SUR
Svalbard and Jan Mayen Islands	SJ	SJM
Swaziland	SZ	SWZ
Sweden	SE	SWE
Switzerland	CH	CHE
Syrian Arab Republic	SY	SYR
<b>—T—</b>		
Taiwan, Province of China	TW	TWN
Tajikistan	TJ	TJK
Tanzania, United Republic of	TZ	TZA
Thailand	TH	THA
Timor–Leste	TL	TLS
Togo	TG	TGO
Tokelau	TK	TKL
Tonga	TO	TON
Trinidad and Tobago	TT	TTO
Tunisia	TN	TUN

<i>Geographical entity</i>	<i>Two-letter code</i>	<i>Three-letter code</i>
Turkey	TR	TUR
Turkmenistan	TM	TKM
Turks and Caicos Islands	TC	TCA
Tuvalu	TV	TUV
<b>—U—</b>		
Uganda	UG	UGA
Ukraine	UA	UKR
United Arab Emirates	AE	AER
United Kingdom	GB	GBR
United States	US	USA
United States Minor Outlying Islands	UM	UMI
Uruguay	UY	URY
Uzbekistan	UZ	UZB
<b>—V—</b>		
Vanuatu	VU	VUT
Venezuela	VE	VEN
Viet Nam	VN	VNM
Virgin Islands (British)	VG	VGB
Virgin Islands (US)	VI	VIR
<b>—W—</b>		
Wallis and Futuna Islands	WF	WLF
Western Sahara	EH	ESH
<b>—Y—</b>		
Yemen	YE	YEM
Yugoslavia, Federal Republic of	YU	YUG
<b>—Z—</b>		
Zambia	ZM	ZMB
Zimbabwe	ZW	ZWE



## Chapter 3

# Military Symbology Basics

This chapter discusses framed symbols, location of amplifiers, the bounding octagon and location of icons and modifiers, the building process for framed symbols, and unframed symbols.

### FRAMED SYMBOLS

3-1. A military symbol is a graphic representation of a unit, equipment, installation, activity, control measure, or tactical task relevant to military operations that is used for planning or to represent the common operational picture on a map, display or overlay. Military symbols are governed by the rules in Military Standard (MIL-STD) 2525C. Military symbols fall into two categories: framed, which includes unit, equipment, installation, and activity symbols; and unframed, which includes control measure and tactical symbols.

3-2. A framed symbol is composed of a frame, color (fill), icon, modifiers, and amplifiers. This section introduces framed symbols.

### FRAME

3-3. The frame is the border of a symbol. It does not include associated information inside or outside of the border. The frame serves as the base to which other symbol components are added. The frame indicates the standard identity, physical domain, and status of the object being represented.















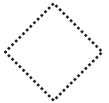







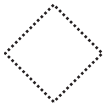







### Standard Identity

3-4. Standard identity reflects the relationship between the viewer and the operational object being monitored. The standard identity categories are unknown, assumed friend, friend, neutral, suspect, and hostile. In the realm of surface operation symbols, a circle or rectangle frame is to denote friend or assumed friend standard identity, a diamond frame to denote hostile or suspect standard identity, a square frame to denote neutral standard identity, and a quatrefoil frame to denote unknown and pending standard identity. Table 3-1, page 3-2, shows frame shapes for standard identities for land symbols.

### Physical Domain

3-5. The physical domain defines the primary mission area for the object within the operational environment. An object can have a mission area above the earth's surface (in the air domain or space domain), on the earth's surface, or below the earth's surface (that is, in the land domain or maritime domain). The land domain includes those mission areas on the land surface or close to the surface (such as land mines and underground shelters). Maritime surface units are depicted in the sea surface dimension. Aircraft, regardless of Service ownership, are depicted in the air dimension while air facilities are depicted as land installations. Land equipment is depicted in the land dimension. Likewise, a landing craft whose primary mission is ferrying personnel or equipment to and from shore are represented in the sea surface dimension. However, a landing craft whose primary mission is to fight on land is a ground asset and is represented in the land dimension.

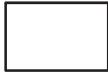
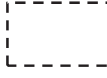

Table 3-1. Frame shapes for standard identities

Standard identity	Friendly	Hostile	Neutral	Unknown
	Assumed friend	Suspect		Pending
Unit				
				
Equipment				
				
Installation				
				
Activity				
				

## Status

3-6. Status indicates whether an operational object exists at the location identified (status is “present” or “confirmed”), will in the future reside at that location (status is “planned” or “anticipated”), or is thought to reside at that location (suspected). The symbol frame is a solid line when indicating a present status and a dashed line when indicating anticipated, planned, or suspected status. When the standard identity of the frame is uncertain, as is the case for assumed friend, suspect, or pending, the status cannot be displayed. Additionally, the status cannot be shown when the symbol is unframed (equipment only) or is displayed as a dot. Table 3-2, page 3-3 shows examples of status.

**Table 3-2. Examples of status**

	<b><i>Present</i></b>	<b><i>Planned</i></b>
Friendly		
	<b><i>Present</i></b>	<b><i>Suspect</i></b>
Hostile		

**COLOR (FILL)**

3-7. In framed symbols, color provides a redundant clue with regard to standard identity. The fill is the interior area within a symbol. If color is not used, the fill is transparent. In unframed symbols (equipment), color is the sole indicator of standard identity, excluding text amplifiers. Blue for friendly or assumed friend, red for hostile or suspect, green for neutral, and yellow for unknown or pending are the default colors used to designate standard identity.

**ICONS FOR FRAMED SYMBOLS**

3-8. The icon is the innermost part of a symbol. The icon provides an abstract pictorial or alphanumeric representation of units, equipment, installations, or activities. This publication distinguishes between icons that must be framed and icons for which framing is optional.

**MODIFIERS FOR FRAMED SYMBOLS**

3-9. A modifier provides an abstract pictorial or alphanumeric representation, displayed in conjunction with an icon. The modifier provides additional information about the icon (unit, equipment, installation, or activity) being displayed. Modifiers conform to the bounding octagon and are placed either above or below the icon. This publication defines various types of modifiers and indicates where each is to be placed in relation to the icon within the symbol.

**AMPLIFIERS FOR FRAMED SYMBOLS**

3-10. An amplifier provides additional information about the symbol being portrayed and is displayed outside the frame. Figure 3-1, page 3-4, shows the essential amplifier fields around a friendly land unit symbol frame. To avoid cluttering the display, only essential amplifiers should be used. Arabic numerals are used to show the unique designation of units, except for corps, which use Roman numerals.

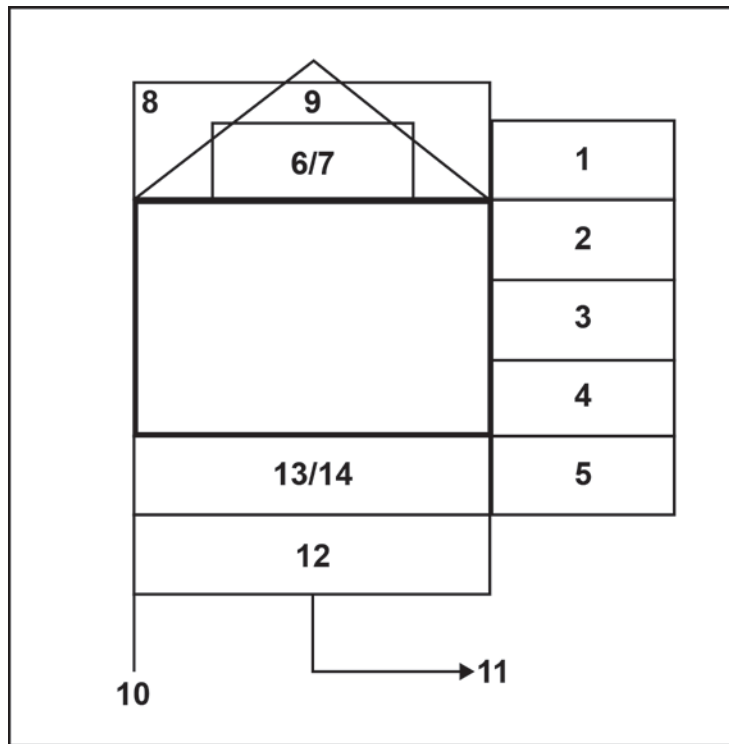

Figure 3-1. Amplifier locations

## LOCATION OF AMPLIFIERS FOR FRAMED SYMBOLS

3-11. The purpose of amplifier placement is to standardize the location of information. Figure 3-1 also illustrates the placement of amplifiers around a frame. The placement of amplifier information is the same regardless of frame shape. Table 3-3, page 3-5, provides a description of those amplifiers for framed symbols.

**Table 3-3. Description of amplifier fields**

<b>Field</b>	<b>Description</b>
<b>1</b>	Indicates whether the unit is <b>reinforced, detached, or both</b> .
<b>2</b>	An accepted code that shows the <b>country indicator</b> .
<b>3</b>	A <b>unique alphanumeric designation</b> that identifies the unit being displayed. <b>Note:</b> When showing unique alphanumeric designations for combat arms regimental units in accordance with AR 600–82 (air defense artillery, armor, aviation, cavalry, field artillery, infantry, and special forces), the following rules apply: No regimental headquarters: A dash (–) is used between the battalion and the regimental designation where there is no regimental headquarters. (Example: A/6–37 for A Battery, 6th Battalion, 37th Field Artillery) Regimental headquarters: A slash (/) is used between the battalion and the regimental designation where there is a regimental headquarters of an active operational unit, to show continuity of the units. (Example: F/2/11 for F Troop, 2d Squadron/11th Armored Cavalry Regiment)
<b>4</b>	Number or title of the next <b>higher formation</b> of the unit being displayed.
<b>5</b>	Free text <b>staff comments</b> for information required by the commander.
<b>6</b>	<b>Echelon</b> indicator of the symbol. (See table 4-5.)
<b>7</b>	<b>Quantity</b> that identifies the number of items present.
<b>8</b>	<b>Task force</b> amplifier placed over the echelon. (See table 4-6.)
<b>9</b>	<b>Feint or dummy indicator</b> shows that the element is being used for deception purposes. Note: The dummy indicator appears as shown in figure 3-1 and can be used for all framed symbol sets. For control measures, it is a control measure symbol used in conjunction with other control measures. (See table 8-6 for feint or dummy symbols.)
<b>10</b>	<b>Headquarters staff indicator</b> identifies symbol as a headquarters. (See figure 4-2.)
	<b>Offset location indicator</b> is used to denote precise location of headquarters or to declutter multiple unit locations and headquarters. (See figure 4-2.)
<b>11</b>	The <b>direction of movement arrow</b> indicates the direction the symbol is moving or will move.
	The <b>offset location indicator</b> without the arrow is used to denote precise location of units or to declutter multiple unit locations, except for headquarters. (See figure 4-1.)
<b>12</b>	<b>Combat effectiveness</b> of unit or equipment displayed.
<b>13</b>	<b>Mobility indicator</b> of the equipment being displayed. (See figure 5-1 and table 5-3.)
<b>14</b>	Indicates what type of <b>headquarters element</b> is being displayed. (See table 4-8.)

## THE BOUNDING OCTAGON AND THE LOCATION OF ICONS AND MODIFIERS FOR FRAMED SYMBOLS

3-12. The bounding octagon serves as the spatial reference for placement of icons and modifiers within the frame of a symbol. It is divided into three sectors. The three sectors specify where icons and modifiers are positioned and how much space is available for sizing of icons and modifiers. Table 3-4 provides examples showing the horizontal and vertical bounding octagons and all examples for all frame shapes.

**Table 3-4. Examples of horizontal and vertical bounding octagons**

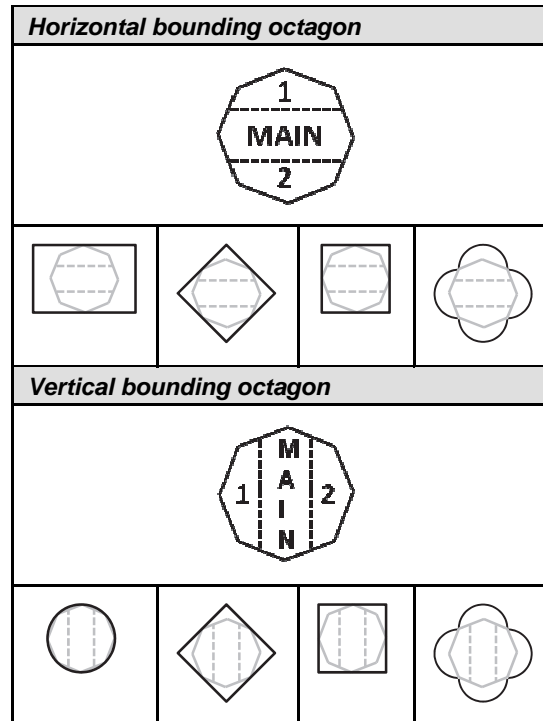

3-13. In general, icons should not be so large as to exceed the dimensions of the main sector of the bounding octagon or touch the interior border of the frame. However, there are exceptions to this size rule. In those cases the icons will occupy the entire frame and must, therefore, exceed the dimensions of the main sector of the bounding octagon and touch the interior border of the frame. These are called full-frame icons and occur only in the land domain. Figure 3-2 shows an example of a full-frame icon for all frame shapes.

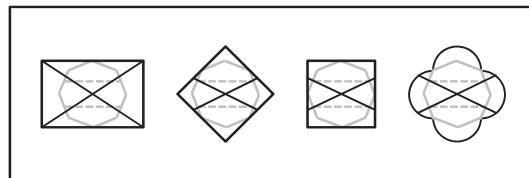

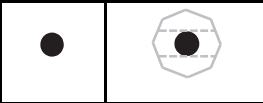
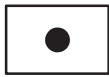
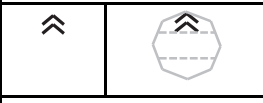



**Figure 3-2. Example of full-frame icon**

## THE BUILDING PROCESS FOR FRAMED SYMBOLS

3-14. Chapters 4 through 7 provide an extensive number of icons and modifiers for building a wide variety of framed symbols. No attempt has been made to depict all possible combinations. Instead, a standard method for constructing symbols is presented. Once the user is familiar with the prescribed system, any desired symbol can be developed using the logical sequence provided in this chapter. The icons shown in

this publication are adequate for depicting all standard identities for framed symbols. When representing unorthodox framed symbols, users select the most appropriate icon or modifier contained herein. Soldiers should avoid using any icon or modifiers or combinations and modifications that differ from those in this publication. If, after searching doctrinal icons and modifiers, it is necessary to create a new symbol, users should explain the symbol in an accompanying legend. Computer-generated systems will have difficulty in passing nonstandard symbols. Table 3-5 shows the steps in the building process for framed symbols.

**Table 3-5. Building process for framed symbols**

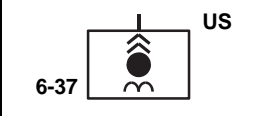
Step	Description	Example
1	Choose appropriate frame shape from table 3-1.	
2	Choose appropriate main icon from chapters 2 through 5 and combine it with frame.	
		
3	Choose appropriate sector 1 modifier from chapters 2 through 5.	
		
4	Choose appropriate sector 2 modifier from chapters 2 through 5.	
		
5	Choose minimum essential amplifiers from those listed in table 3-3.	

## UNFRAMED SYMBOLS

3-15. This section discusses unframed symbols. Control measure symbols and mission task verb symbols are unframed symbols. They conform to rules within their own elements.

### CONTROL MEASURE SYMBOLS

3-16. A control measure is a means of regulating forces or warfighting functions. Control measures may be boundaries, special area designations, or other unique markings related to an operational environment's geometry and necessary for planning and managing operations. Control measure symbols represent control measures that can be portrayed graphically and provide operational information. They can be displayed as points, lines, and areas. Control measure symbols can be combined with other military symbols, icons and amplifiers to display operational information. Control measure symbols follow the same basic building rules as framed symbols but are built in accordance with their template. Control measure symbols can be black or white, depending on display background: blue (friendly), red (hostile), green (obstacles), or yellow (chemical, biological, radiological, and nuclear [CBRN] contaminated area fill). Description, placement, and further details of control measure symbols are addressed in chapter 8. Table 3-6, page 3-8, shows descriptions of control measure amplifier fields. Table 3-7, page 3-9, shows the steps in the building process for control measure symbols. (See chapter 8 for more information about control measure symbols.)

## Icons for Control Measures

3-17. The icon provides an abstract pictorial representation of the control measure.

## Modifiers for Control Measures

3-18. Only chemical, biological, radiological, and nuclear events and contaminated areas have modifiers.

## Amplifiers for Control Measures

3-19. As with the framed symbols, the amplifier provides additional information about the icon being displayed. However, the location of the amplifiers for control measures varies and is dependent on the control measure symbol being displayed. Because the location of amplifiers varies, there is no standardized amplifier placement location for all types of control measures. Chapter 8 provides numerous figures and tables that identify the location of amplifiers for each of the different types of control measures. Arabic numerals are used when showing the unique designation of units, except for corps, which are identified with Roman numerals.

**Table 3-6. Description of control measure symbol amplifier fields**

<b>Field</b>	<b>Description</b>
<b>2</b>	An accepted code that shows the <b>country indicator</b> .
<b>3</b>	An <b>unique alphanumeric designation</b> that identifies the unit being displayed or a <b>name, letter, or number</b> . <b>Note:</b> When showing unique alphanumeric designations for combat arms regimental units in accordance with AR 600–82 (air defense artillery, armor, aviation, cavalry, field artillery, infantry, and special forces), the following rules apply: No regimental headquarters: A dash (–) is used between the battalion and the regimental designation where there is no regimental headquarters. (Example: A/6–37 for A Battery, 6th Battalion, 37th Field Artillery) Regimental headquarters: A slash (/) is used between the battalion and the regimental designation where there is a regimental headquarters of an active operational unit, to show continuity of the units. (Example: F/2/11 for F Troop, 2d Squadron/11th Armored Cavalry Regiment)
<b>5</b>	Free text <b>staff comments</b> for information required by the commander.
<b>6</b>	<b>Echelon</b> indicator of the symbol.
<b>7</b>	<b>Quantity</b> that identifies the number of items present. For a nuclear event, identifies the actual or estimated <b>size of the nuclear weapon</b> used in kilotons (KT) or megatons (MT).
<b>11</b>	The <b>direction of movement arrow</b> indicates the direction the symbol is moving or will move. For chemical, biological, radiological or nuclear events, the direction of movement arrow indicates <b>downwind direction</b> . The <b>offset location indicator</b> without the arrow is used to denote precise location of units or to declutter multiple unit locations, except for headquarters.
<b>15</b>	Denotes <b>enemy</b> symbol. The letters “ENY” are used when color red is not used.
<b>16</b>	An alphanumeric designator for displaying a <b>date-time group</b> (DDHHMMSSZMONYYYY) or “O/O” for on order.
<b>16-1</b>	Used with 16 for displaying a <b>date-time group</b> for a from-to specified time period.
<b>17</b>	Identifies unique designation for <b>type of equipment</b> .
<b>18</b>	Denotes the <b>location</b> in latitude and longitude or grid coordinates.

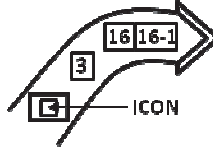
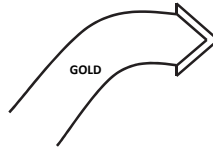
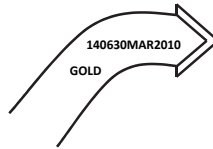
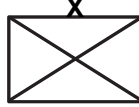
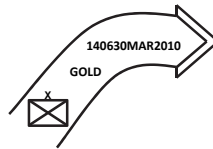

**Table 3-7. Building process for control measure symbols**

<b>Step</b>	<b>Description</b>	<b>Example</b>		
1	Choose the appropriate control measure symbol.			
2	Choose the appropriate control measure template that will show the possible amplifiers.			
3	Choose the appropriate amplifier information by field.	<table border="1" data-bbox="950 583 1377 667"> <tr> <td><b>3</b></td> <td><b>GOLD</b></td> </tr> </table>	<b>3</b>	<b>GOLD</b>
		<b>3</b>	<b>GOLD</b>	
				
4	Choose the next appropriate amplifier information by field.	<b>16</b>		
		<b>140600MAR2010</b>		
		<b>16-1</b>		
		Not required		
				
5	Choose the appropriate framed icon.			
				

**TACTICAL MISSION TASK SYMBOLS**

3-20. The tactical mission task symbols are graphical representations of many of the tactical tasks. However, not all tactical tasks have an associated symbol. Tactical task symbols are for use in course of action sketches, synchronization matrixes, and maneuver sketches. They do not replace any part of the operation order. The tactical task symbols should be scaled to fit the map scale and the size of unit represented. Chapter 9 discusses tactical mission task symbols.

**This page intentionally left blank.**

## Chapter 4















# Units, Individuals, and Organizations

This chapter discusses symbols for units, individuals, and organizations.

### MAIN ICONS FOR UNITS

4-1. A *unit* is a military element whose structure is prescribed by a competent authority, such as a table of organization and equipment; specifically, part of an organization (JP 1-02). Icons in the main sector of the bounding octagon reflect the main function of the symbol (see table 3-4, page 3-6). Table 4-1 shows the main icons for units.

**Table 4-1. Main icons for units**

<b><i>Function (historical derivation of icon shown in italics)</i></b>	<b>Icon</b>
Armor ( <i>tank track</i> )	
Aviation ( <i>rotary wing</i> )	
Chemical, biological, radiological, and nuclear ( <i>Crossed retorts</i> )	
Civil affairs	<b>CA</b>
Combat support (maneuver enhancement)	
Combined arms	
Electronic warfare	<b>EW</b>
Engineer ( <i>bridge</i> )	
Explosive ordnance disposal	<b>EOD</b>
Field artillery ( <i>cannonball</i> )	
Military intelligence ( <i>abbreviation</i> )	<b>MI</b>
Military police ( <i>abbreviation</i> )	<b>MP</b>
Missile ( <i>missile</i> )	
Mortar	
Ordnance ( <i>bursting Bomb</i> )	
Special forces ( <i>abbreviation</i> )	<b>SF</b>
Surveillance	
Sustainment ( <i>abbreviation</i> )	<b>SUST</b>
Transportation ( <i>wheel</i> )	
Unmanned systems	
Water	

## FULL-FRAME ICONS FOR UNITS

4-2. Full-frame icons may reflect the main function of the symbol or may reflect modifying information. Table 4-2 shows full-frame icons for units.









**Table 4-2. Full-frame icons for units**

<b><i>Function</i></b> <b><i>(Historical derivation of icon shown in italics)</i></b>	<b><i>Icon</i></b>	<b><i>Example</i></b>
Air defense <i>(radar dome)</i>		
Antitank or antiarmor <i>(upside down V)</i>		
Armored cavalry		
Armored infantry (mechanized infantry)		
Corps support		
Headquarters or headquarters element		
Infantry <i>(crossed straps)</i>		
Medical <i>(Geneva cross)</i>		
Mobile gun system <b>Note:</b> The mobile gun system is a variant of the Stryker system.		
Reconnaissance (cavalry) <i>(cavalry bandoleer)</i>		
Signal <i>(lightning flash)</i>		
Supply		
Theater or echelons above corps support		

**SECTOR 1 MODIFIERS FOR UNITS**

4-3. Table 4-3 shows sector 1 modifiers for units. Sector 1 modifiers reflect a unit's specific capability.















**Table 4-3. Sector 1 modifiers for units**

<i>Description</i>	<i>Modifier</i>	<i>Capability Type</i>
Attack	<b>A</b>	Equipment
Armored		Protection
Biological	<b>B</b>	CBRN
Bridging		Equipment
Chemical	<b>C</b>	CBRN
Command and control	<b>C2</b>	
Detention	<b>DET</b>	
Maintenance		
Meteorological	<b>MET</b>	
Multiple rocket launcher		Equipment
Nuclear	<b>N</b>	CBRN
Radar		Equipment
Radiological	<b>R</b>	CBRN
Search and rescue	<b>SAR</b>	
Sensor		Equipment
Smoke	<b>S</b>	CBRN
Sniper		Equipment
Unmanned systems		Equipment
Utility	<b>U</b>	
Video imagery		Equipment
CBRN – chemical, biological, radiological, and nuclear		

## SECTOR 2 MODIFIERS FOR UNITS

4-4. Table 4-4 shows sector 2 icons. Sector 2 modifiers reflect the mobility of the unit or size, range, or altitude of unit equipment.

**Table 4-4. Sector 2 modifiers for units**

<i>Description</i>	<i>Icon</i>	<i>Capability Type</i>
Air assault		Mobility
Airborne		Mobility
Amphibious		Mobility
Arctic (sled)		Mobility
Bicycle-equipped		Mobility
Decontamination	<b>D</b>	Chemical, biological, radiological, and nuclear (CBRN)
Heavy	<b>H</b>	Size/range/altitude
High altitude	<b>HA</b>	Size/range/altitude
Light	<b>L</b>	Size/range/altitude
Long range	<b>LR</b>	Size/range/altitude
Low altitude	<b>LA</b>	Size/range/altitude
Medium	<b>M</b>	Size/range/altitude
Medium altitude	<b>MA</b>	Size/range/altitude
Medium range	<b>MR</b>	Size/range/altitude
Mountain		Mobility
Pack animal		Mobility
Railroad		Mobility
Recovery		
Riverine		Mobility
Short range	<b>SR</b>	Mobility
Ski		Mobility
Towed		Mobility
Tracked/self-propelled		Mobility
Wheeled		Mobility

**ECHELON AMPLIFIERS (FIELD 6)**

4-5. An *echelon* is a separate level of command (JP 1-02). In addition, there is also a separate echelon known as a command. A command is a unit or units, an organization, or an area under the command of one individual. It does not correspond to any of the other echelons. Table 4-5 shows the field 6 amplifiers for Army echelons and commands.

**Table 4-5. Echelon amplifiers**

<i>Echelon</i>	<i>Amplifier</i>
Team/crew	∅
Squad	●
Section	● ●
Platoon/detachment	● ● ●
Company/battery/troop	I
Battalion/squadron	II
Regiment/group	III
Brigade	×
Division	× ×
Corps	× × ×
Army	× × × ×
Army group	× × × × ×
Theater	× × × × × ×
<i>Nonechelon</i>	<i>Amplifier</i>
Command	⊕ ⊕

**TASK FORCE AMPLIFIERS (FIELD 8)**

4-6. A task force is a temporary grouping of units under one commander formed to carry out a specific operation or mission, or a semipermanent organization of units under one commander formed to carry out a continuing specified task. Table 4-6 shows the task force amplifier.

**Table 4-6. Task force amplifier**

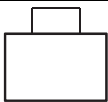
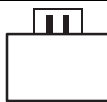
<i>Task force amplifier</i>	<i>Example</i>	<i>Example with echelon</i>
		

**REINFORCED, DETACHED, OR BOTH AMPLIFIERS (FIELD 1)**

4-7. This amplifier is used at division level and below. The reinforced amplifier + (plus) indicates that the capability of one unit has been augmented by the capability of another unit. The detached amplifier – (minus) indicates that the capability of a unit has been reduced by the detachment of one or more of its units. If a unit has been both reinforced and detached, then the  $\pm$  amplifier is used. Table 4-7 shows the reinforced, detached, or both amplifiers.

**Table 4-7. Reinforced, reduced, or both amplifiers**

<i>Description</i>	<i>Amplifier</i>
Reinforced	<b>+</b>
Reduced	<b>–</b>
Both (reinforced and reduced)	<b><math>\pm</math></b>

**COMMAND POSTS AND COMMAND GROUP AMPLIFIERS (FIELD 14)**

4-8. A command post is a unit headquarters where the commander and staff perform their activities. A command group is the commander and selected staff members who accompany commanders and enable them to exercise mission command away from a command post. The headquarters staff indicator (field 10) is always used in conjunction with the command post and command group amplifiers. Table 4-8 shows the command post and command group amplifiers (field 14).

**Table 4-8. Command post and command group amplifiers**

<i>Description</i>	<i>Amplifier</i>
Combat trains command post	<b>CTCP</b>
Command group	<b>CMD</b>
Early entry command post	<b>EECP</b>
Emergency operations center	<b>EOC</b>
Forward trains command post	<b>FTCP</b>
Main command post	<b>MAIN</b>
Tactical command post	<b>TAC</b>

**COMBAT EFFECTIVENESS AMPLIFIERS (FIELD 12)**





4-9. Combat effectiveness is the ability of a unit to perform its mission. Factors such as ammunition, personnel, fuel status, and weapon systems are evaluated and rated. The ratings are—

- Fully operational (green).
- Substantially operational (amber).
- Marginally operational (red).
- Not operational (black).

Field 12 is used to display the level of combat effectiveness of the unit or equipment symbol. Table 4-9, page 4-7, shows the combat effectiveness amplifiers (field 12). (See chapter 10 for a discussion of combat effectiveness icons used with task organization composition symbols.)

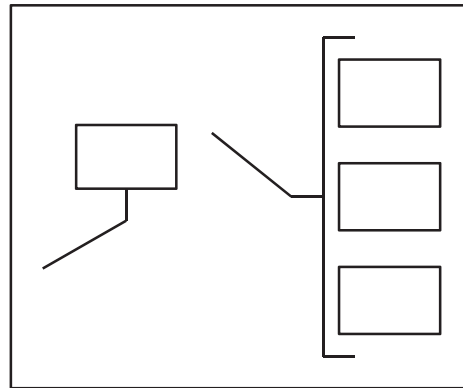

**Table 4-9. Combat effectiveness amplifiers**

<i>Description</i>	<i>Amplifier</i>
Fully operational	
Substantially operational	
Marginally operational	
Not operational	

**OFFSET LOCATOR INDICATOR AMPLIFIER (FIELD 11) AND HEADQUARTERS STAFF OFFSET LOCATOR INDICATOR AMPLIFIER (FIELD 10)**

4-10. The center of mass of the unit symbol indicates the general vicinity of the center of mass of the unit. To indicate precise location or reduce clutter in an area with multiple units, a line (without an arrow) extends from the center of the bottom of the frame to the unit location displayed as field 11. The line may be extended or bent as needed. If a group of units (or installations) other than a headquarters is at one location, the grouping of the symbols may be enclosed with a bracket and the exact location indicated by a line from the centre of the bracket. Figure 4-1 shows examples of how to use the offset locator indicator.



**Figure 4-1. Offset locator indicators**

4-11. To indicate precise location or reduce clutter of headquarters unit symbols, a staff extends from the bottom left hand corner to the headquarters location displayed as field 10. This staff may be bent or extended as needed. If several headquarters are at one location, more than one headquarters can be on a single staff. The highest echelon headquarters is placed on top, followed by the next levels in descending order. Figure 4-2, page 4-8, shows examples of how the headquarters offset locator indicator is used. Table 4-10, page 4-8, gives examples of unit symbols.

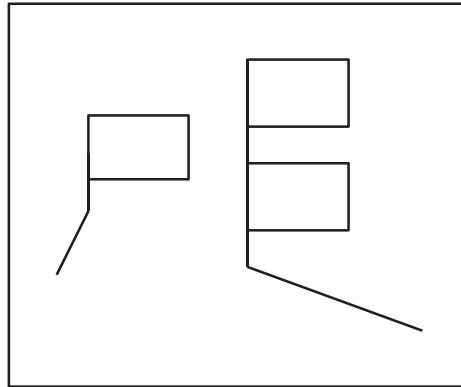



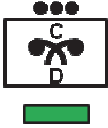

Figure 4-2. Headquarters offset locator indicators









Table 4-10. Examples of unit symbols

<i>Description</i>	<i>Symbol</i>
Battery C, 3d Battalion, 319th Field Artillery (Air Assault)	 <span data-bbox="1052 888 1130 911">C/3-319</span>
181st Transportation Battalion, V Corps, United States	 <span data-bbox="1052 1014 1089 1083">US 181 V</span>
3d Battalion, 31st Infantry Battalion (Stryker), 2d Infantry Division	 <span data-bbox="1052 1171 1097 1220">3-31 2</span>
1st Platoon (Decontamination), B Company, 421st Chemical Battalion—Fully Capable	 <span data-bbox="1052 1335 1127 1358">1/B/421</span>

## MAIN ICONS FOR INDIVIDUALS AND ORGANIZATIONS (CIVILIAN)

4-12. Symbols for individuals and organizations represent civilians and normally do not have prescribed structures. Organization symbols can reflect civic, ethnic, religious, social, or other groupings. Icons in the main sector reflect the main function of the icon. Table 4-11 shows the main icons for civilian individuals and organizations.

**Table 4-11. Main icons for civilian individuals and organizations**

<i>Function</i>	<i>Icon</i>
Fire department	
Governmental	<b>GO</b>
Nongovernmental	<b>NGO</b>
Pirates	
Police department	
<b>Unspecified individual or organization</b>	
Unspecified individual <i>Note:</i> Only this icon uses the vertical bounding octagon. All other icons in this table use the horizontal bounding octagon.	
Unspecified organization	
Criminal activities victim	
Criminal activities victims	
Attempted criminal activities victim	
Attempted criminal activities victims	

## SECTOR 1 MODIFIERS FOR INDIVIDUALS AND ORGANIZATIONS

4-13. Table 4-12, page 4-10 shows sector 1 modifiers. Sector 1 modifiers reflect the function of civilian individuals or organizations.

**Table 4-12. Sector 1 modifiers for civilian individuals and organizations**

	<i>Characteristic</i>	<i>Modifier</i>
<b>Types of killing victims</b>	Assassinated	<b>AS</b>
	Executed	<b>EX</b>
	Murdered	<b>MU</b>
<b>Types of criminal activities victims</b>	Hijacked	<b>H</b>
	Kidnapped	<b>K</b>
	Piracy	<b>PI</b>
	Rape	<b>RA</b>
<b>Types of civilian individuals and organizations</b>	Displaced persons, refugees, and evacuees	<b>DPRE</b>
	Foreign fighters	<b>FF</b>
	Gang	<b>GANG</b>
	Leader	<b>LDR</b>
	Religious	<b>REL</b>
	Terrorist	<b>TER</b>



**SECTOR 2 MODIFIERS FOR INDIVIDUALS AND ORGANIZATIONS**

4-14. Table 4-13 shows sector 2 modifiers for individuals and organizations. Sector 2 modifiers reflect the nature of the relationship of civilian individuals or organizations. Table 4-14 shows examples civilian individuals and organizations symbols.

**Table 4-13. Sector 2 modifiers for civilian individuals and organizations**

<i>Characteristic (Types of recruitment)</i>	<i>Modifier</i>
Coerced	<b>C</b>
Willing	<b>W</b>

**Table 4-14. Examples of symbols for civilian individuals and organizations**

<i>Description</i>	<i>Symbol</i>
Terrorist	
Murdered criminal activities victim	
Coerced foreign fighters	

## Chapter 5 Equipment

This chapter discusses main icons, sector 1 modifiers, and mobility indicator amplifiers for equipment.













### MAIN ICONS FOR EQUIPMENT

5-1. Equipment is all nonexpendable items needed to outfit or equip an individual or organization. **Equipment symbols can be used with or without frames. When frames are not used, then standard identity color must be used.** Icons in the main sector reflect the main function of the symbol. Equipment can use either the horizontal or vertical bounding octagon depending on the icon. Table 5-1, pages 5-1 to 5-3, shows the main icons for equipment.

**Table 5-1. Main icons for equipment**

<i>Description</i>	<i>Icon</i>
<b>Weapon systems</b>	
<p><b>Note.</b> Weapon systems, missile launchers, and nonlethal weapons use the horizontal bounding octagon and a unique system for indicating size, altitude, or range. Weapons size is indicated by a horizontal line(s) perpendicular to the weapon icon. If an equipment symbol has no lines, it is a basic equipment symbol. Adding one line designates it as light, low altitude, or short-range. Adding two lines designates it as medium, medium altitude, or medium-range. Finally, adding three lines designates it as heavy, high altitude, or long-range. If a weapon system is designated as greater than heavy, high altitude, or long-range, then a heavy, high-altitude, or long-range indicator is used.</p>	
Unspecified weapon	
Flame thrower	┌
Grenade launcher	⦿
<b>Guns</b>	
<i>Description</i>	<i>Icon</i>
Air defense gun	⦿
Antitank gun	⦿
Direct fire gun	
Recoilless gun	↑
Howitzer	⦿
Machine gun	↑

Table 5-1. Main icons for equipment (continued)

<i>Description</i>	<i>Icon</i>
<b>Missile launchers</b>	
Missile launcher	
Air defense missile launcher surface-to-air missile launcher	
Antitank missile launcher	
Surface-to-surface missile launcher	
Mortar	
Rifle	
<i>Description</i>	<i>Icon</i>
<b>Rockets</b>	
Single rocket launcher	
Multiple rocket launcher	
Antitank rocket launcher	
<i>Description</i>	<i>Icon</i>
<b>Nonlethal weapons</b>	
Nonlethal weapon	
Taser	
Water cannon	

(Table 5-1 continues on page 5-3.)

Table 5-1. Main icons for equipment (continued)

<i>Description</i>	<i>Icon</i>
<b>Vehicles</b>	
<p><b>Note:</b> Vehicle systems use a unique system for indicating size or range. Vehicle size is indicated by either horizontal or vertical line(s) within the icon depending on the orientation of the symbol. If an equipment symbol has no lines, it is a basic equipment symbol. Adding one line designates it as light or short-range. Adding two lines designates it as medium or medium-range. Finally, adding three lines designates it as heavy or long-range.</p> <p><b>Note:</b> Armored fighting vehicles, armoured personnel carriers, earthmovers, and tanks use the horizontal bounding octagon. All remaining equipment icons use the vertical bounding octagon.</p>	
Armored fighting vehicle	
Armored personnel carrier	
Armored protected vehicle	
Earthmover	
Tank	
Train locomotive	
Utility vehicle	
<i>Description</i>	<i>Icon</i>
<b>Other equipment</b>	
Bridge	
Chemical, biological, radiological, or nuclear (CBRN) equipment	
Improvised explosive device	<b>IED</b>
<i>Description</i>	<i>Icon</i>
<b>Mines</b>	
Antipersonnel mine	
Antitank mine	
Unspecified mine	
Radar	
Sensor	

## SECTOR 1 MODIFIERS FOR EQUIPMENT

5-2. Table 5-2 shows sector 1 modifiers for equipment.

**Table 5-2. Sector 1 modifiers for equipment**

<i>Description</i>	<i>Modifier</i>
Light	<b>L</b>
Medium	<b>M</b>
Heavy	<b>H</b>

## MOBILITY INDICATOR AMPLIFIER (FIELD 13)

5-3. Mobility indicator amplifiers are used for both framed and unframed icons but are displayed in different locations for each. Figure 5-1 shows examples of how each is displayed. Table 5-3 shows mobility indicator amplifiers.

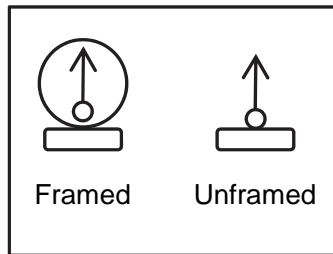

**Figure 5-1. Examples of mobility indicator amplifiers for framed and unframed equipment symbols**

**Table 5-3. Mobility indicator amplifiers for equipment**

<i>Description</i>	<i>Amplifier</i>
Amphibious	~ ~ ~ ~
Barge	⌒
Over snow (prime mover)	└──┘
Pack animal	Λ
Railway	⊖ ⊖ ⊖
Sled	└──┘
Towed	○ — ○
Tracked	▭
Wheeled (cross-country)	⊖ ⊖ ⊖
Wheeled (limited mobility)	○ — ○
Wheeled and tracked	○ └──┘



## Chapter 6







# Installations

This chapter discusses main icons, sector 1 modifiers, and sector 2 modifiers for installations.

### MAIN ICONS FOR INSTALLATIONS

6-1. Installations are sites that incorporate permanent, semipermanent, and temporary structures. Icons in the main sector reflect the main function of the symbol. Table 6-1 shows the main icons for installations.

**Table 6-1. Main icons for installations**

<i>Function</i>	<i>Icon</i>
Airport	
Electric power plant	
Mass grave	
Mine	
Sea port	
Telecommunications	

## SECTOR 1 MODIFIERS FOR INSTALLATIONS

6-2. Table 6-2 shows sector 1 modifiers. Sector 1 modifiers reflect the specific capability of the installation.

**Table 6-2. Sector 1 modifiers for installations**

	<i>Description</i>	<i>Modifier</i>
<b>Electric power plant fuel source</b>	Coal	<b>CO</b>
	Geothermal	<b>GT</b>
	Hydroelectric	<b>HY</b>
	Natural gas	<b>NG</b>
	Petroleum	<b>Y</b>
	<i>Description</i>	<i>Modifier</i>
<b>Telecommunications</b>	Radio	<b>R</b>
	Telephone	<b>T</b>
	Television	<b>TV</b>

## SECTOR 2 MODIFIERS FOR INSTALLATIONS

6-3. Table 6-3 shows sector 2 modifiers. Sector 2 modifiers reflect the specific type of installation.

**Table 6-3. Sector 2 modifiers for installations**

<i>Description</i>	<i>Modifier</i>
Production	<b>PROD</b>
Repair	<b>RPR</b>
Research	<b>RSH</b>
Service	<b>SVC</b>
Storage	<b>STOR</b>
Test	<b>TEST</b>









## Chapter 7 Activities

This chapter discusses main icons and sector 1 modifiers for activities.

### MAIN ICONS FOR ACTIVITIES

7-1. Activities symbols are applicable across the range of military operations, but they normally focus on stability activities and defense support of civil authorities activities. Activities can affect military operations. Activities represented by icons can include acts of terrorism, sabotage, organized crime, disrupting the flow of vital resources, and the uncontrolled movement of large numbers of people. Icons in the main sector reflect the main function of the symbol. Table 7-1 shows the main icons for activities.

**Table 7-1. Main icons for activities**

<i>Function</i>	<i>Icon</i>
Arrest	
Attempted against an individual	
Attempted against multiple individuals or an organization	
Demonstration	<b>MASS</b>
Drug related	<b>DRUG</b>
Explosion	
Extortion	<b>\$</b>
Graffiti	
Killing—individual	
Killing—multiple individuals or an organization	
Killing—poisoning	
Killing—riot	<b>RIOT</b>

**SECTOR 1 MODIFIERS FOR ACTIVITIES**

7-2. Table 7-2 shows sector 1 modifiers. Sector 1 modifiers reflect the specific type of activity.

**Table 7-2. Sector 1 modifiers for activities**

	<i>Characteristic</i>	<i>Modifier</i>
<i>Types of killings</i>	Assassination	<b>AS</b>
	Wrongful execution	<b>EX</b>
	Murder	<b>MU</b>
	<i>Characteristic</i>	<i>Modifier</i>
<i>Criminal activities</i>	Hijacking	<b>H</b>
	Kidnapping	<b>K</b>
	Piracy	<b>PI</b>
	Rape	<b>RA</b>

## Chapter 8

# Control Measure Symbols

This chapter discusses basics, points, lines, boundary lines, areas, and abbreviations and acronyms for use with control measure symbols.

### **BASICS OF CONTROL MEASURE SYMBOLS**

8-1. A control measure symbol is a graphic used on maps and displays to regulate forces and warfighting functions. See chapter 1 for the definitions of terms related to control measure symbols. The control measure symbols in this chapter are organized by warfighting functions: mission command, movement and maneuver, fires, protection, sustainment, and intelligence. Also included are airspace control measures, which are a combination of movement and maneuver, fires, and protection. Control measure symbols generally fall into one of three categories: points, lines, or areas. The coloring and labeling of control measure symbols is almost identical to framed symbols.

### **COLOR OF CONTROL MEASURE SYMBOLS**

8-2. Friendly graphic control measures are shown in black or blue. Hostile graphic control measures are shown in red. If red is not available, they are shown in black with the abbreviation “ENY” placed on the graphic in amplifier field 15. If a special requirement arises to show neutral or unknown graphic control measures, they are shown in black, and the abbreviations of “NEU” for neutral or “UNK” for unknown are used in amplifier field 15. All obstacles, regardless of standard identity, are shown in green. If green is not available, obstacles should be shown using black. Yellow is used for the cross-hatching of areas with chemical, biological, radiological, or nuclear (CBRN) contamination. The use of green and yellow for obstacles and CBRN contamination is in contradiction to the standard identities.

### **LETTERING FOR CONTROL MEASURE SYMBOLS**

8-3. All lettering for icons and amplifier fields must be in upper case (all capital letters). All lettering should be oriented horizontally, from left to right, so that readers can see it easily without having to tilt their head.

### **ABBREVIATIONS FOR CONTROL MEASURE SYMBOLS**

8-4. Abbreviations in this publication must be used for Army control measure symbols. No abbreviations other than those provided in this publication may be used.

### **AMPLIFIER FIELDS FOR CONTROL MEASURE SYMBOLS**

8-5. See table 3-6 for descriptions of all the amplifier fields for control measure symbols. For control measures, field 3 can represent either a unique alphanumeric designation that identifies the establishing unit, or a name, letter, or number.

### **POINT SYMBOLS**

8-6. A point is a control measure symbol that has only one set of coordinates. Most Army point symbols follow a standard format. Figure 8-1, page 8-2, shows the composition and placement of an icon, its modifiers, and its amplifiers for a standard point and a supply point. The external amplifier field 3 is used to designate the unit being service or other unique designation, while the internal amplifier field 3 is used to

designate the unit providing the service. Point symbols cannot be rotated; therefore, text must be written horizontally only (not on an angle or diagonal).

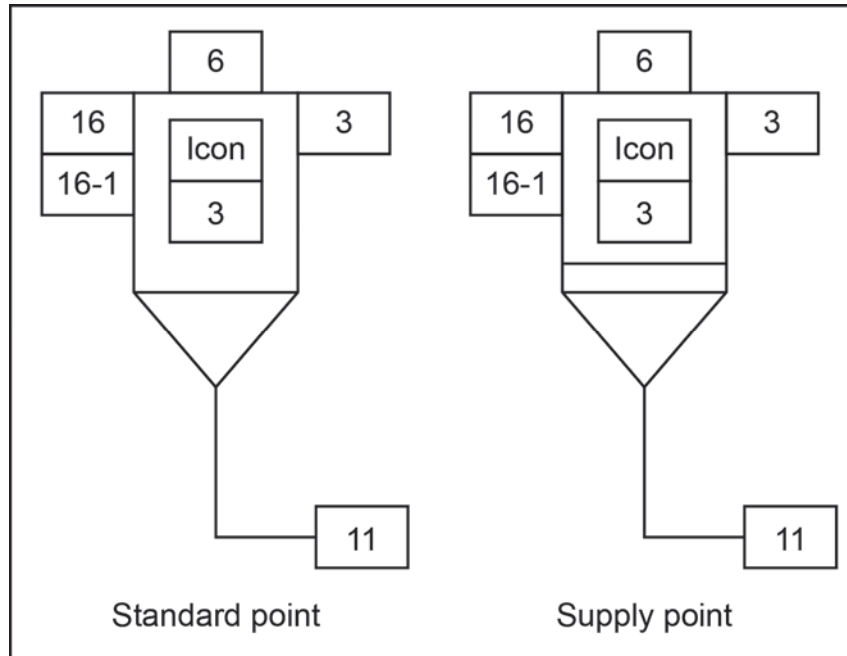

Figure 8-1. Standard point and supply point templates

## LINE SYMBOLS

8-7. A line is a control measure symbol with multiple sets of coordinates. Figure 8-2 shows the composition and placement of an icon, its modifiers, and its amplifiers for a standard line. Most lines are also labelled as phase lines for easy reference in orders and during transmissions. A phase line is marked as PL, with the line's name in field 3. When lines representing other purposes are marked as phase lines, they should show their primary purpose in the icon field (such as NFL for no fire line). The purpose of the line is labelled on top of the line at both ends inside the lateral boundaries or as often as necessary for clarity. Field 3 is used for fire support coordination measures, to show the designation of the controlling headquarters. The use of phase lines to mark line control measure symbols is not mandatory.

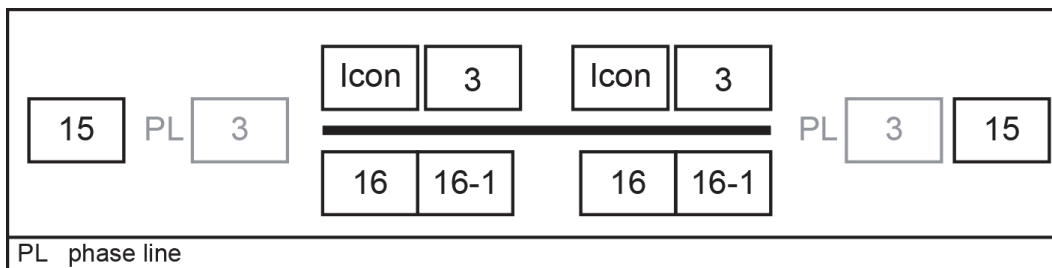

Figure 8-2. Standard line template

## BOUNDARY LINE SYMBOLS

8-8. A *boundary* is a line that delineates surface areas for the purpose of facilitating coordination and deconfliction of operations between adjacent units, formations, or areas (JP 3-0). There are three types of boundary lines: lateral, rear, and forward. Amplifiers are displayed perpendicular to the boundary line. Figure 8-3 shows standard horizontal (east-west) and vertical (north-south) boundary lines and the orientation of their amplifiers. The graphic for the highest echelon (field 6) unit on lateral boundaries is used for the boundary line. The graphic for the lower echelon (field 6) unit on a rear or forward boundary is used for the boundary line. When units of the same echelon are adjacent to each other, the abbreviated echelon designator (field 3, such as CO, BN, or BDE) can be omitted from the alphanumeric designator. Table 8-7, pages 8-12 to 8-13, and table 8-8, page 8-14, provide a list of abbreviations and acronyms used in field 3. When the boundary is between units of different countries, the three-letter country code (field 2) is shown in parentheses behind or below the unit designation.

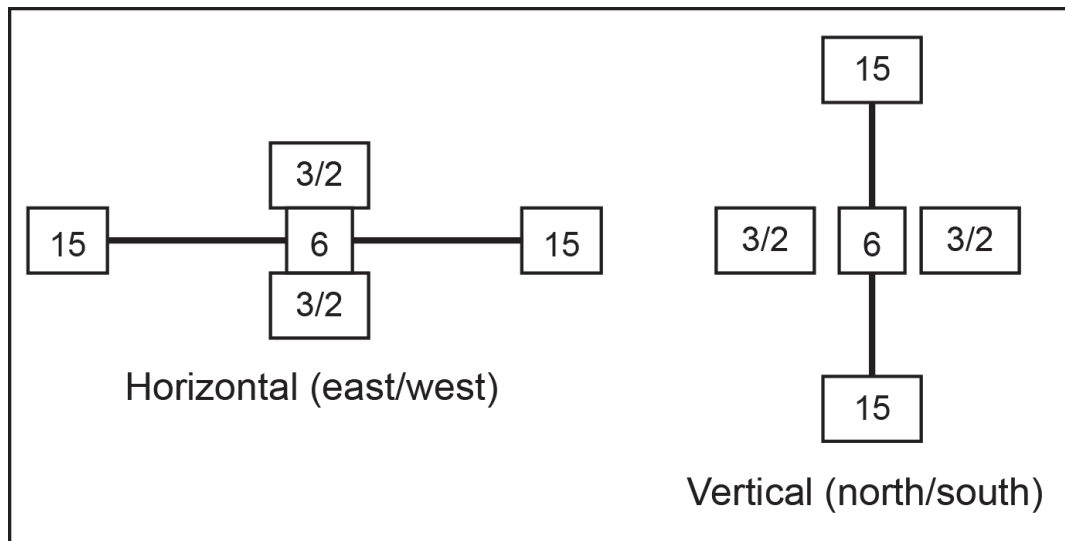

Figure 8-3. Horizontal and vertical boundary templates

## AREA SYMBOLS

8-9. An area is a control measure symbol with multiple sets of coordinates that start and finish at the same point. Figure 8-4, page 8-4 shows the composition and placement of an icon, its modifiers, and its amplifiers for a standard area. Areas normally are marked with the abbreviation for the type of area in the icon field, followed by a name in field 3. This labeling should be in the center of the area unless the area is too small or the labeling would interfere with locating units. The type of area determines the number of fields being used. Not all fields are required for each area. Some areas may use only one field, while other will use several.

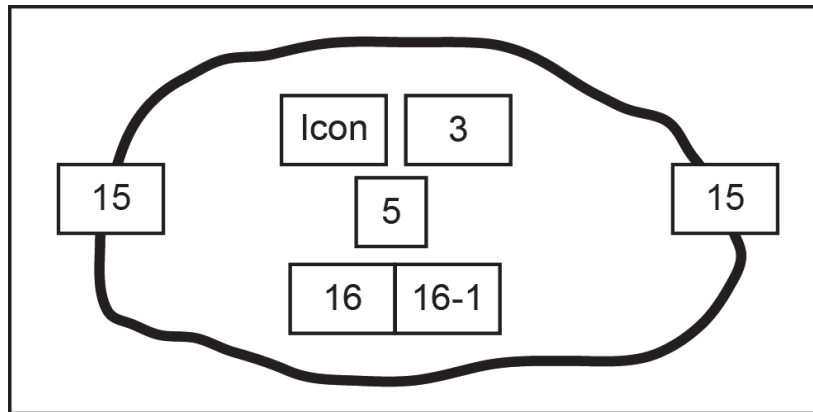

Figure 8-4. Standard area template

**MISSION COMMAND (COMMAND AND CONTROL)**

8-10. Table 8-1 shows mission command (or command and control) control measure symbols.

**Table 8-1. Mission command**



<i>Type</i>	<i>Icon</i>
<b>Points</b>	
Coordination point	
Decision point	
Checkpoint	<b>CKP</b>
Linkup point	<b>LU</b>
Passage point	<b>PP</b>
Rally point	<b>RLY</b>
Release point	<b>RP</b>
Start point	<b>SP</b>
<i>Type</i>	<i>Icon</i>
<b>Lines</b>	
Light line	<b>LL</b>
<i>Type</i>	<i>Icon</i>
<b>Areas</b>	
Area of operations	<b>AO</b>
Named area of interest	<b>NAI</b>
Targeted area of interest	<b>TAI</b>



## MOVEMENT AND MANEUVER

8-11. Table 8-2, pages 8-5 to 8-7, shows movement and maneuver control measure symbols. These symbols are further subdivided into general, defensive, and offensive symbols.

Table 8-2. Movement and maneuver

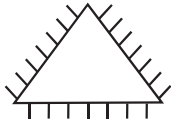
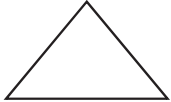
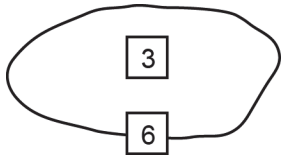
Type	Icon
<b>General</b>	
Points	
Point of interest	
Lines	
Forward line of troops	
Handover line	<b>HL</b>
Phase line	<b>PL</b>
Areas	
Assembly area	<b>AA</b>
Drop zone	<b>DZ</b>
Extraction zone	<b>EZ</b>
Landing zone	<b>LZ</b>
Pickup zone	<b>PZ</b>
<b>Defensive</b>	
Points	
Combat outpost	
Observation post	
Lines	
Final protective line	<b>FPL</b>
Areas	
Battle position	 <b>Note:</b> The side opposite (field 6) always faces toward the hostile force.

**Table 8-2. Movement and maneuver (continued)**

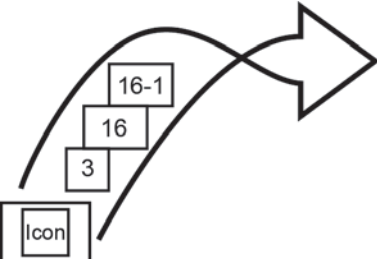
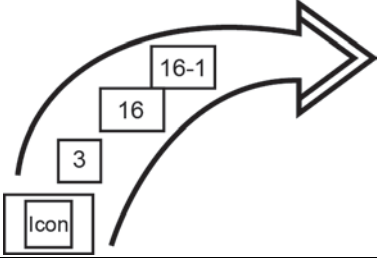
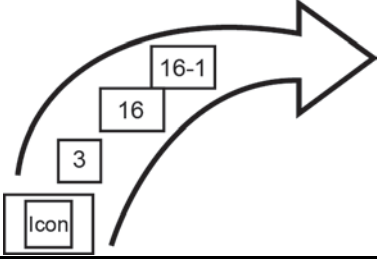
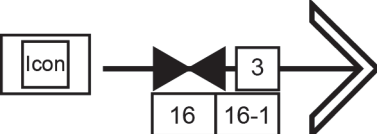
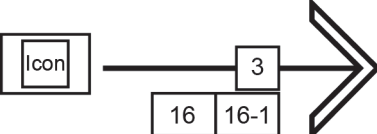
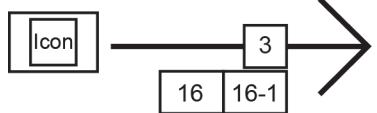
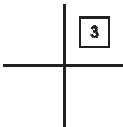
<i>Type</i>	<i>Icon</i>
<b>Offensive</b>	
Axis of advance	
Airborne/aviation (supporting attack)	
Main attack	
Supporting attack	
Direction of attack	
Aviation (main attack)	
Main attack	
Supporting attack	
Points	
<p>Target reference point</p> <p><b>Note:</b> Task force units and below use target reference points (TRPs). A TRP can delineate sectors of fire within an engagement area. TRPs are designated using the standard target symbol or numbers issued by the fire support officer. Once designated, TRPs can also constitute indirect fire targets.</p>	

(Table 8-2 continues on page 8-7.)

Table 8-2. Movement and maneuver (continued)

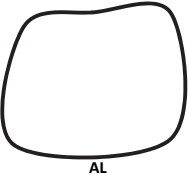
<i>Type</i>	<i>Icon</i>
Lines	
Bridgehead line	<b>BL</b>
Final coordination line	<b>FCL</b>
Holding line	<b>HL</b>
Limit of advance	<b>LOA</b>
Line of departure	<b>LD</b>
Line of departure/line of contact	<b>LD/LC</b>
Probable line of deployment	<b>PLD</b> <i>Note:</i> Use the planned status for the line.
Release line	<b>RL</b>
Areas	
Assault position	<b>ASLT</b>
Attack position	<b>ATK</b>
Objective	<b>OBJ</b>
Special areas	
Airhead/airhead line	 <b>AL</b> <i>Note:</i> An airhead/airhead line can be an area or a line.

**FIRES**

8-12. Table 8-3 shows fires control measure symbols.

**Table 8-3. Fires**

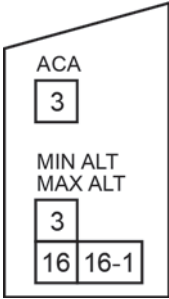
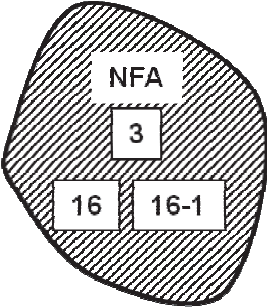
<i>Type</i>	<i>Icon</i>
<b>Fire support coordination measures</b>	
<b>Points</b>	
Fire support station	
<b>Lines</b>	
Coordinated fire line	<b>CFL</b>
Fire support coordination line	<b>FSCL</b>
Restrictive fire line	<b>RFL</b>
<b>Areas</b>	
Airspace coordination area	
Free fire area	<b>FFA</b>
No-fire area	 <b>Note:</b> No fire area has black cross-hatching.
Restrictive fire area	<b>RFA</b>

**PROTECTION**

8-13. Table 8-4, page 8-9, shows protection control measure symbols.









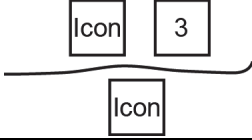

Table 8-4. Protection

Type	Icon
<b>Points</b>	
<b>Chemical, biological, radiological, or nuclear (CBRN) events</b>	
<b>Displaced Persons, Refugees, and Evacuees</b>	
Type	Sector 1 modifier icon
Biological	<b>B</b>
Chemical	<b>C</b>
Nuclear	<b>N</b>
Radiological	<b>R</b>
Type	Sector 2 modifier icon
Toxic industrial material	<b>T</b>
<b>Areas</b>	
<b>Chemical, biological, radiological, or nuclear (CBRN) contaminated</b>	
<p><b>Notes:</b> Cross-hatched lines are in yellow and outline is in black. Use sector 1 and sector 2 modifier icons and fields from CBRN events.</p>	
<b>Displaced Persons, Refugees, and Evacuees</b>	
Type	Icon
Detainee holding area	<b>DET</b>
Enemy prisoner of war holding area	<b>EPW</b>
Refugee holding	<b>REF</b>

SUSTAINMENT

8-14. Table 8-5 shows sustainment control measure symbols.

**Table 8-5. Sustainment**

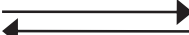
<i>Type</i>	<i>Icon</i>
<b>Points</b>	
Ammunition supply point	<b>ASP</b>
Ammunition transfer point	<b>ATP</b>
Rearm, refuel, and resupply point	<b>R3P</b>
Refuel on the move	<b>ROM</b>
<b>Supply points</b>	
Class I	
Class II	<b>II</b>
Class III	
Class IV	
Class V	
Class VI	
Class VII	
Class VIII	
Class IX	
Class X	<b>CA</b>
<b>Lines</b>	
<b>Routes</b>	
	
<i>Type</i>	<i>Top Icon</i>
Alternate supply route	<b>ASR</b>
Main supply route	<b>MSR</b>
<i>Type</i>	<i>Bottom Icon</i>
Alternating traffic	
One-way traffic	
Two-way traffic	
<b>Areas</b>	
Brigade support area	<b>BSA</b>
Forward arming and refuel point	<b>FARP</b>

## INTELLIGENCE

8-15. Table 8-6 shows intelligence control measure symbols.

**Table 8-6. Intelligence**

Point, line, or area	
Type	Icon
Decoy/dummy/feint/phoney	 <p><b>Note:</b> The icon refers to another control measure icon, such as axis of advance, direction of attack, or minefield.</p>

**AIRSPACE CONTROL MEASURES**

8-16. Table 8-7, pages 8-12 to 8-13, shows airspace control measure symbols.

**Table 8-7. Airspace control**









Type	Icons
<b>Points</b>	
Air control point	
Communications checkpoint	
<b>Corridors/routes</b>	
Air corridor	
Low-level transit route	
Minimum risk route	
Standard Army aircraft flight route	<p style="text-align: center;">NAME WIDTH MIN ALT MAX ALT</p> 
Unmanned aerial vehicle/unmanned aircraft route	
<b>Areas</b>	
	
High-altitude missile engagement zone	<b>HIMEZ</b>
High-density airspace control zone	<b>HIDACZ</b>

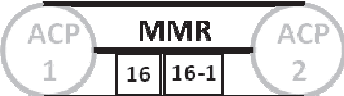

Table 8-7. Airspace control (continued)

<i>Type</i>	<i>Icons</i>
Low-altitude missile engagement zone	<b>LOMEZ</b>
Missile engagement zone	<b>MEZ</b>
Restricted operations zone	<b>ROZ</b>
Short-range air defense engagement zone	<b>SHORADEZ</b>
Weapons-free zone	

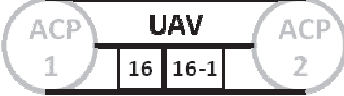
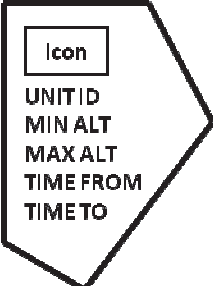
## ABBREVIATIONS AND ACRONYMS FOR USE WITH CONTROL MEASURE SYMBOLS

8-17. Table 8-8, page 8-14, provides a list of abbreviations and acronyms for echelons and functional organizations to be used with boundaries.

Table 8-8. Abbreviations and acronyms for use with boundaries

<b><i>Echelon</i></b>	<b><i>Abbreviation or acronym</i></b>	<b><i>Examples</i></b> Note: A 2- or 3-letter country code in parentheses may follow unit designation, such as 3 DIV (UK).
Army group	AG	1AG
Army	A	3A
Corps	CORPS	IICORPS <b>Note:</b> Corps uses Roman numerals.
Division	DIV	1DIV
Air assault division	AAD	101AAD
Airborne division	ABD	6ABD
Armoured division	AD	2AD
Cavalry division	CD	1CD
Infantry division	ID	52ID
Mechanized division	MD	4MD
Mountain division	MTND	10MTND
Multinational division	MND	1MND or MND(S) <b>Note:</b> Multinational divisions may use geographical references in parentheses.
Brigade	BDE	2BDE
Air assault brigade	AAB	8AAB
Airborne brigade	ABB	3ABB
Brigade combat team	BCT	4BCT
Fires brigade	FB	41FB
Multinational brigade	MNB	2MNB
Naval infantry brigade	NIB	4NIB
Separate armor brigade	SAB	194SAB
Separate infantry brigade	SIB	197SIB
Regiment	REGT	21REGT
Airborne regiment	ABR	901ABR
Group	GP	41GP
Battle group	BG	5BG
Battalion	BN	7BN
Company	CO <sup>1</sup>	ACO or 2CO
Platoon	PLT	2PLT
Team	TM	BTM

<sup>1</sup> North Atlantic Treaty Organization (NATO) uses COY

8-18. Table 8-9 provides a list of abbreviations and acronyms used in control measure symbols for unit functions.

**Table 8-9. Abbreviation and acronyms used in control measure symbols for unit functions**

<b>Function</b>	<b>Abbreviation or acronym</b>
Air defense	ADA <b>Note:</b> ADA used to prevent confusion with AD for armored division.
Armor	AR
Antitank/anti-armor	AT
Aviation	AVN
Cavalry	CAV
Chemical, biological, radiological, and nuclear (CBRN)	CB <b>Note:</b> CB used in lieu of CBRN.
Civil affairs	CA
Combined arms	CAR
Counterintelligence	CI
Electronic warfare	EW
Engineer	EN
Explosive ordnance disposal	EOD
Field artillery	FA
Infantry	IN
Logistics	LOG
Maintenance	MNT <b>Note:</b> MNT used in lieu of MAINT.
Medical	MED
Military intelligence	MI
Military police	MP
Naval	NAV
Ordnance	ORD
Quartermaster	QM
Reconnaissance	REC <b>Note:</b> REC used in lieu of RECON.
Signal	SIG
Special forces	SF
Special operations force	SOF
Surveillance	SUR <b>Note:</b> SUR used in lieu of SURVEIL.
Sustainment	SUST
Transportation	TPT <b>Note:</b> TPT used in lieu of TRANS.

**This page intentionally left blank.**

## Chapter 9

# Tactical Mission Tasks

This chapter defines tactical mission tasks and provides symbols for them.

### TACTICAL MISSION TASKS DEFINED

9-1. A task is a clearly defined and measurable activity accomplished by individuals or organizations. A *tactical mission task* is a specific activity performed by a unit while executing a form of tactical operation or form of maneuver. A tactical mission task may be expressed as either an action by a friendly force or effects on an enemy force (FM 7-15). The tactical mission tasks describe the results or effects the commander wants to achieve.





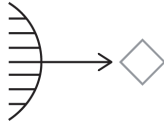
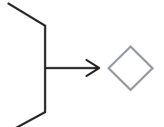
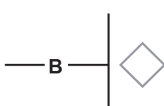

### SYMBOLS FOR TACTICAL MISSION TASKS

9-2. Table 9-1, pages 9-1 to 9-5, shows the tactical mission tasks that have symbols. Not all tactical mission tasks have symbols. Most of the tactical mission tasks shown in table 9-1 are defined in chapter 1. Some tactical mission task symbols will include unit symbols, and the tactical mission task “delay until a specified time” will use an amplifier. However, no modifiers are used with tactical mission task symbols. Tactical mission task symbols are used in course of action sketches, synchronization matrixes, and maneuver sketches. They do not replace any part of the operation order. Tactical mission task symbols are sized to accommodate the scale of the display or map being used. Where practical, the tactical mission task symbol connects with the task organization composition symbol centered of the left or right side of the symbol or at the center of the bottom of the symbol, depending on the orientation of the symbols. Figure 9-1, page 9-6, shows an example of a tactical mission task symbol connected to task organization composition symbol.

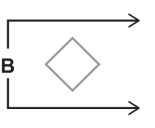
**Table 9-1. Tactical mission task symbols**

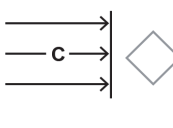

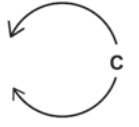
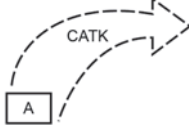

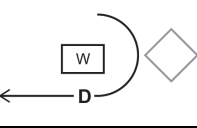
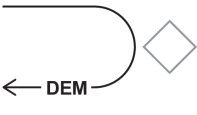

<i>Task</i>	<i>Symbol</i> <i>Note:</i> The friendly or hostile frame (gray) is not part of the symbol; it is for orientation only.
Ambush	
Attack by fire	
Block	

**Table 9-1. Tactical mission task symbols (continued)**

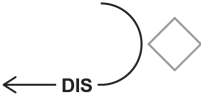
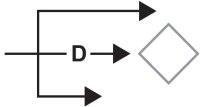
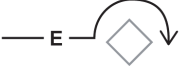
<b>Task</b>	<b>Symbol</b> <i>Note:</i> The friendly or hostile frame (gray) is not part of the symbol; it is for orientation only.
Breach	
Bypass	
Canalize	
Clear	
Contain	
Control	
Counterattack	
Counterattack by fire	
Delay or delay (until a specific time)	
Demonstration	

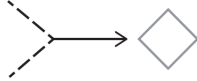

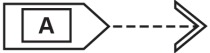



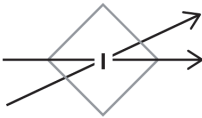

(Table 9-1 continues on page 9-3.)

**Table 9-1. Tactical mission task symbols (continued)**

<b>Task</b>	<b>Symbol</b> <i>Note:</i> The friendly or hostile frame (gray) is not part of the symbol; it is for orientation only.
Destroy	
Disengage/disengagement	
Disrupt	
Envelopment	
Exfiltrate	
Exploit	
Feint	
Fix	
Follow and assume	
Follow and support	
Infiltration/infiltrate	

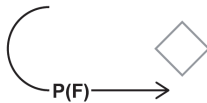
(Table 9-1 continues on page 9-4.)

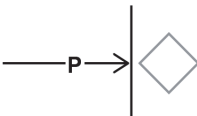
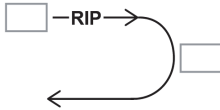
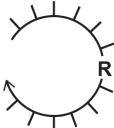

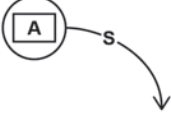
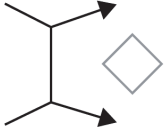

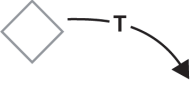
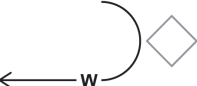

**Table 9-1. Tactical mission task symbols (continued)**

<b>Task</b>	<b>Symbol</b> <i>Note:</i> The friendly or hostile frame (gray) is not part of the symbol; it is for orientation only.
Interdict	
Isolate	
Neutralize	
Occupy	
Passage of lines (forward)	
Passage of lines (rearward)	
Penetration/penetrate	
Relief in place	
Retain	
Retirement	

(Table 9-1 continues on page 9-5.)



Table 9-1. Tactical mission task symbols (continued)

<b>Task</b>	<b>Symbol</b> <i>Note:</i> The friendly or hostile frame (gray) is not part of the symbol; it is for orientation only.
Secure	
<b>Security</b>	
	
<i>Note:</i> Unit to perform security is placed in the center of symbol.	
<b>Type</b>	<b>Icon</b>
Security (screen)	<b>S</b>
Security (cover)	<b>C</b>
Security (guard)	<b>G</b>
Seize	
Support by fire	
Suppress	
Turn	
Withdraw	
Withdraw under pressure	

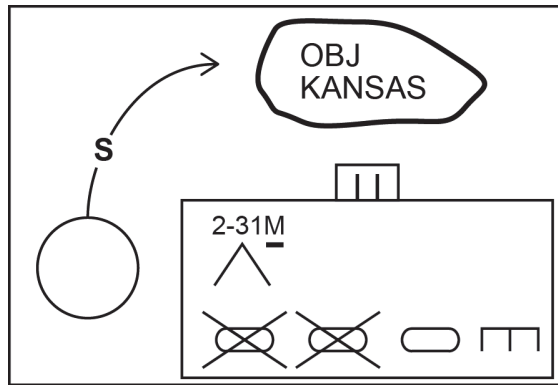

**Figure 9-1. Example of tactical mission task symbol connected to task organization composition symbol**

## Chapter 10

# Course of Action Sketch

This chapter discusses the purpose and makeup of a course of action sketch.

### PURPOSE OF COURSE OF ACTION SKETCH

10-1. A *course of action* is a scheme developed to accomplish a mission (JP 5-0). It constitutes a broad potential solution to an identified problem. A course of action statement clearly portrays how the unit will accomplish the mission. The course of action statement should be a brief expression of how the combined arms concept will be conducted. The course of action sketch is the graphical portrayal of the course of action statement.

### MAKEUP OF COURSE OF ACTION SKETCH

10-2. The course of action sketch provides a picture of the movement and maneuver aspects of the concept, including the positioning of forces. The course of action sketch becomes the basis for the operation overlay. At a minimum, the course of action sketch includes the array of generic forces and control measures, such as—

- Unit and subordinate unit boundaries.
- Unit movement formations (but not subordinate unit formations).
- Line of departure, or line of contact and phase lines, if used.
- Reconnaissance and security graphics.
- Ground and air axes of advance.
- Assembly areas, battle positions, strong points, engagement areas, and objectives.
- Obstacle control measures and tactical mission graphics.
- Fire support coordination and airspace control measures.
- Main effort.
- Location of command posts and critical information systems nodes.
- Enemy locations, known or templated.
- Population concentrations.

Most symbols for use on the course of action sketch are shown in chapters 4 through 9. However, the unit symbols do not provide decisionmakers with a quick and easy method of portraying detailed information relating to task organization composition or combat effectiveness. Task organization composition symbols portray detailed information for course of action sketches.

### TASK ORGANIZATION COMPOSITION SYMBOLS

10-3. The task organization portion of the operation order specifies the resources available to the land maneuver commander, in a detailed list. The headquarters and individual units of the task organization are portrayed graphically with unit symbols shown in chapter 4. These symbols provide a rapid and easily understood means—through situation maps, overlays, and annotated aerial photographs—to express an operation plan, concept, or friendly or hostile (enemy) situation. Figure 10-1, page 10-2, shows a comparison of a unit symbol and task organization composition symbols.

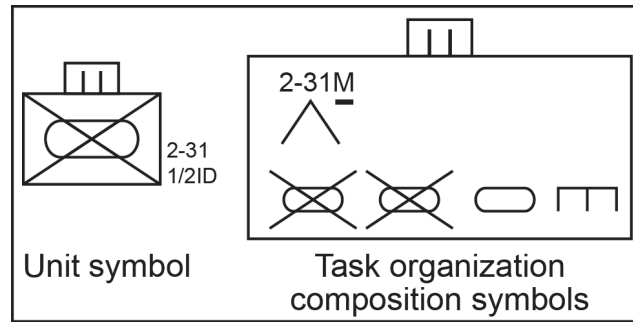

**Figure 10-1. Comparison of sample unit and task organization composition symbols**

10-4. A task organization composition symbol is built using a rectangular frame. Figure 10-2 shows icon and amplifier locations for task organization composition symbols (see chapter 3 for an explanation of icons and amplifiers). Centered in the middle on the top of the frame are the echelon (field 6) and task force (field 8), if required. Inside the top portion of the frame, on the left side, the unique designation (field 3) of the organization is shown. Inside the top portion of the frame, on the right side, the combat effectiveness (field 12) of the organization is shown. Inside the middle portion of the frame are symbols for any unit that is reinforced, reduced, or both. (reinforced and reduced). Inside the bottom portion of the frame are symbols for remaining units. If no units are reinforced, reduced, or both (reinforced and reduced), then units are shown below the unique designation. If any unit is not one echelon lower than the designated unit on line 1, then the echelon indicator amplifier is used above the task organization unit icon (field 6). (See table 4-7 for echelon amplifiers.) Figure 10-2 depicts sample unit and task organization composition symbols.

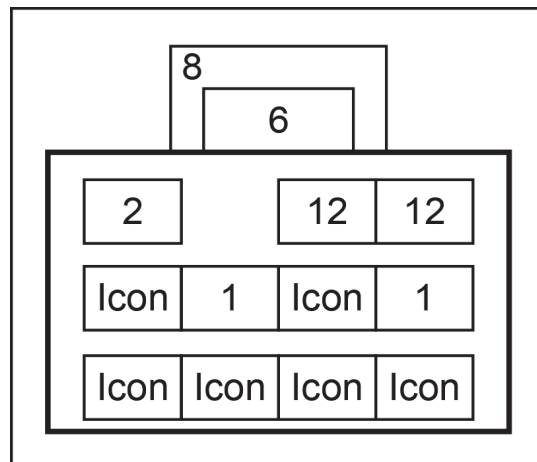



















**Figure 10-2. Task organization composition symbol example**

### TASK ORGANIZATION ICONS

10-5. In all cases, task organization icons are the same as unit icons and amplifiers. Table 10-1 shows the most commonly used icons and modifiers in their appropriate configurations.

**Table 10-1. Task organization icons**









<i>Function</i>	<i>Symbol</i>	<i>Function</i>	<i>Symbol</i>
Air defense		Field artillery	
Armor		Infantry	
Armored reconnaissance (cavalry) Note: Reconnaissance (Cavalry) unit that is both armored and tracked		Air assault infantry	
Antitank		Airborne infantry	
Attack helicopter		Light infantry	
Air cavalry		Mechanized infantry <i>Note:</i> Infantry unit that is both armored and tracked.	
Assault/lift helicopter		Medium infantry (Stryker)	
Combined arms		Mountain infantry	
Engineer		Reconnaissance (cavalry/scout)	

### COMBAT EFFECTIVENESS ICONS

10-6. Combat effectiveness refers to the ability of a unit to perform its mission. Factors such as ammunition, personnel, status of fuel, and weapon systems availability are assessed and rated. The commander uses this information to provide a net assessment of the unit's ability to perform its mission. This assessment can then be expressed graphically using combat effectiveness icons. Table 10-2 shows two sets of combat effectiveness icons, which may be also used with task organization composition symbol.

10-7. Table 10-2 visually depicts combat effectiveness icons for the overall combat rating of the unit in the center column. Table 10-2 specifies combat effectiveness icons for the status of selected items of interest in the right column. The four selected items shown in the right column are ammunition; weapons; petroleum, oils, and lubricants (POL); and personnel. Standard operating procedures will specify the items of interest to be reported. The commander may add to this list for internal reporting and tracking.

Table 10-2. Combat effectiveness icons

<p><b>Commander's assessment of unit's ability to perform its mission</b></p>	<p><b>Effectiveness pie charts</b></p>	<p><b>Selected status pie chart</b></p> <p>Selected status pie chart                      Personnel — Ammunition                      POL — Weapons</p>
<p>No problems in any area</p>		
<p>Some problems in personnel</p>		
<p>Major problems in weapon systems</p>		
<p>Cannot perform mission: personnel, ammunition, and weapons problems</p>		
<p><b>LEGEND</b> POL — petroleum, oils, and lubricants</p>		

**EXAMPLE OF A TASK ORGANIZATION COMPOSITION SYMBOL**

10-8. See figure 10-3 for an example of a task organization symbol for a brigade combat team.

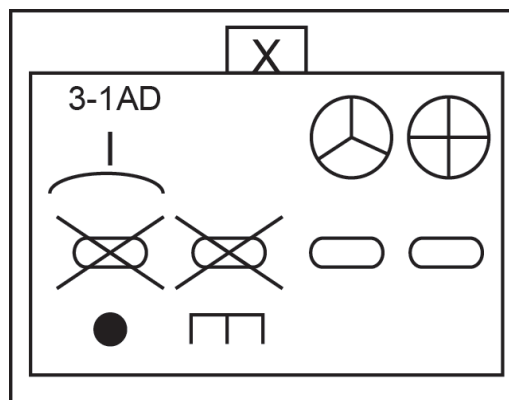

Figure 10-3. Brigade combat team example

## References

Army publications and selected joint publications are listed by new number followed by old number, if applicable, in parentheses.

### REQUIRED PUBLICATIONS

These documents must be available to intended users of this publication.

JP 1-02. *Department of Defense Dictionary of Military and Associated Terms*. 08 November 2010, as amended through 15 June 2013.

MIL-STD-2525(C). *Common Warfighting Symbology*. 17 November 2008.

### RELATED PUBLICATIONS

These documents contain relevant supplemental information.

### INTERNATIONAL STANDARDIZATION AGREEMENTS

AAP-15(2013). *NATO Glossary of Abbreviations Used in NATO Documents and Publications (English and French)*. 27 February 2013.

STANAG 1059 (ED. 8). *Letter Codes for Geographical Entities*. 19 February 2004.

STANAG 1241 (ED. 5). *NATO Standard Identity Description Structure for Tactical Use*. 6 April 2005.

STANAG 2019 (ED. 6)/APP-6(C). *NATO Joint Military Symbology*. 24 May 2011.

STANAG 3680 (ED. 5)/AAP-06(2012)(2). *NATO Glossary of Terms and Definitions (English and French)*. 3 October 2012.

### DEPARTMENT OF DEFENSE AND JOINT PUBLICATIONS

Most joint publications are available online: <[http://www.dtic.mil/doctrine/new\\_pubs/jointpub.htm](http://www.dtic.mil/doctrine/new_pubs/jointpub.htm)>

CJCSM 5120.01. *Joint Doctrine Development Process*. 13 January 2012.

DODD 2310.01E. *Defense of Defense Law of War Program*. 15 November 2010.

DODD 3025.18. *Defense Support of Civil Authorities*. 29 December 2010.

JP 1. *Doctrine for the Armed Forces of the United States*. 25 March 2013.

JP 1-0. *Joint Personnel Support*. 24 October 2011.

JP 1-04. *Legal Support to Military Operations*. 17 August 2011.

JP 1-05. *Religious Affairs in Joint Operations*. 13 November 2009.

JP 2-0. *Joint Intelligence*. 22 June 2007.

JP 2-01. *Joint and National Intelligence Support to Military Operations*. 5 January 2012.

JP 2-01.3. *Joint Intelligence Preparation of the Operational Environment*. 16 June 2009.

JP 2-03. *Geospatial Intelligence in Joint Operations*. 31 October 2012.

JP 3-0. *Joint Operations*. 11 August 2011.

JP 3-01. *Countering Air and Missile Threats*. 23 March 2012.

JP 3-03. *Joint Interdiction*. 14 October 2011.

JP 3-04. *Joint Shipboard Helicopter Operations*. 30 September 2008.

JP 3-05. *Special Operations*. 18 April 2011.

## References

---

- JP 3-05.1. *Joint Special Operations Task Force Operations*. 26 April 2007.
- JP 3-07.2. *Antiterrorism*. 24 November 2010.
- JP 3-07.3. *Peace Operations*. 1 August 2012.
- JP 3-07.4. *Joint Counterdrug Operations*. 13 June 2007.
- JP 3-08. *Interorganizational Coordination During Joint Operations*. 24 June 2011.
- JP 3-09. *Joint Fire Support*. 30 June 2010.
- JP 3-09.3. *Close Air Support*. 8 July 2009.
- JP 3-10. *Joint Security Operations in Theater*. 3 February 2010.
- JP 3-11. *Operations in Chemical, Biological, Radiological, and Nuclear (CBRN) Environments*. 26 August 2008.
- JP 3-13. *Information Operations*. 27 November 2012.
- JP 3-13.1. *Electronic Warfare*. 8 February 2012.
- JP 3-13.2. *Military Information Support Operations*. 7 January 2010.
- JP 3-13.3. *Operations Security*. 4 January 2012.
- JP 3-13.4. *Military Deception*. 26 January 2012.
- JP 3-14. *Space Operations*. 29 May 2013.
- JP 3-15. *Barriers, Obstacles, and Mine Warfare for Joint Operations*. 17 June 2011.
- JP 3-16. *Multinational Operations*. 7 March 2007.
- JP 3-17. *Air Mobility Operations*. 2 October 2009.
- JP 3-18. *Joint Forcible Entry Operations*. 27 November 2012.
- JP 3-22. *Foreign Internal Defense*. 12 July 2010.
- JP 3-24. *Counterinsurgency Operations*. 5 October 2009.
- JP 3-27. *Homeland Defense*. 12 July 2007.
- JP 3-28. *Civil Support*. 14 September 2007.
- JP 3-29. *Foreign Humanitarian Assistance*. 17 March 2009.
- JP 3-30. *Command and Control for Joint Air Operations*. 12 January 2010.
- JP 3-31. *Command and Control for Joint Land Operations*. 29 June 2010.
- JP 3-33. *Joint Task Force Headquarters*. 30 July 2012.
- JP 3-34. *Joint Engineer Operations*. 30 June 2011.
- JP 3-35. *Deployment and Redeployment Operations*. 31 January 2013.
- JP 3-40. *Combating Weapons of Mass Destruction*. 10 June 2009.
- JP 3-41. *Chemical, Biological, Radiological, and Nuclear Consequence Management*. 21 June 2012.
- JP 3-50. *Personnel Recovery*. 20 December 2011.
- JP 3-52. *Joint Airspace Control*. 2 May 2010.
- JP 3-57. *Civil-Military Operations*. 8 July 2008.
- JP 3-60. *Joint Targeting*. 31 January 2013.
- JP 3-61. *Public Affairs*. 25 August 2010.
- JP 3-63. *Detainee Operations*. 30 May 2008.
- JP 3-68. *Noncombatant Evacuation Operations*. 23 December 2010.
- JP 4-0. *Joint Logistics*. 18 July 2008.
- JP 4-01.2. *Sealift Support to Joint Operations*. 22 June 2012.
- JP 4-01.5. *Joint Terminal Operations*. 6 April 2012.
- JP 4-02. *Health Service Support*. 26 July 2012.
- JP 4-05. *Joint Mobilization Planning*. 22 March 2010.
- JP 4-09. *Distribution Operations*. 5 February 2010.



JP 4-10. *Operational Contract Support*. 17 October 2008.

JP 5-0. *Joint Operation Planning*. 11 August 2011.

JP 6-0. *Joint Communications System*. 10 June 2010.

## ARMY PUBLICATIONS

Most Army doctrinal publications are available online:

[https://armypubs.us.army.mil/doctrine/Active\\_FM.html](https://armypubs.us.army.mil/doctrine/Active_FM.html).

ADP 1-02. *Operational Terms and Military Symbols*. 31 August 2012.

ADP 3-0. *Unified Land Operations*. 10 October 2011.

ADP 3-05. *Special Operations*. 31 August 2012.

ADP 3-07. *Stability*. 31 August 2012.

ADP 3-28. *Defense Support of Civil Authorities*. 26 July 2012.

ADP 3-90. *Offense and Defense*. 31 August 2012.

ADP 4-0. *Sustainment*. 31 July 2012.

ADP 5-0. *The Operations Process*. 17 May 2012.

ADP 6-0. *Mission Command*. 17 May 2012.

ADP 6-22. *Army Leadership*. 1 August 2012.

ADP 7-0. *Training Units and Developing Leaders*. 23 August 2012.

ADRP 1. *The Army Profession*. 14 June 2013.

ADRP 2-0. *Intelligence*. 31 August 2012.

ADRP 3-0. *Unified Land Operations*. 16 May 2012.

ADRP 3-05. *Special Operations*. 31 August 2012.

ADRP 3-07. *Stability*. 31 August 2012.

ADRP 3-09. *Fires*. 31 August 2012.

ADRP 3-28. *Defense Support of Civil Authorities*. 14 June 2013.

ADRP 3-37. *Protection*. 31 August 2012.

ADRP 3-90. *Offense and Defense*. 31 August 2012.

ADRP 4-0. *Sustainment*. 31 July 2012.

ADRP 5-0. *The Operations Process*. 17 May 2012.

ADRP 6-0. *Mission Command*. 17 May 2012.

ADRP 6-22. *Army Leadership*. 1 August 2012.

ADRP 7-0. *Training Units and Developing Leaders*. 23 August 2012.

AR 15-6. *Procedures for Investigating Officers and Boards of Officers*. 2 October 2006.

AR 350-1. *Army Training and Leader Development*. 18 December 2009.

AR 600-82. *The U.S. Army Regimental System*. 5 June 1990.

AR 600-100. *Army Leadership*. 8 March 2007.

ATP 1-0.2. *Theater-Level Human Resources Support*. 4 January 2013.

ATP 1-5.03. *Religious Support and External Advisement*. 3 May 2013.

ATP 1-06.2. *Commanders' Emergency Response Program (CERP)*. 5 April 2013.

ATP 2-22.9. *Open-Source Intelligence*. 10 July 2012.

ATP 3-05.20. *Special Operations Intelligence*. 3 May 2013.

ATP 3-06.1. *Multi-Service Tactics, Techniques, and Procedures for Aviation Urban Operations*.  
19 April 2013.

ATP 3-07.5. *Stability Techniques*. 31 August 2012.

## References

---

- ATP 3-07.20. *Multi-Service Tactics, Techniques, and Procedures for Integrated Monetary Shaping Operations*. 26 April 2013.
- ATP 3-09.24. *Techniques for the Fires Brigade*. 21 November 2012.
- ATP 3-11.37. *Multi-Service Tactics, Techniques, and Procedures for Chemical, Biological, Radiological, and Nuclear Reconnaissance and Surveillance*. 25 March 2013.
- ATP 3-20.15. *Tank Platoon*. 31 December 2012.
- ATP 3-27.5. *AN/TPY-2 Forward Based Mode (FBM) RADAR Operations*. 22 March 2013.
- ATP 3-28.1. *Multi-Service Tactics, Techniques, and Procedures for Defense Support of Civil Authorities*. 11 February 2013.
- ATP 3-37.10. *Base Camps*. 26 April 2013.
- ATP 3-37.34. *Survivability Operations*. 28 June 2013.
- ATP 3-50.3. *Multi-Service Tactics, Techniques, and Procedures for Survival, Evasion, and Recovery*. 11 September 2012.
- ATP 3-55.6. *Multi-Service Tactics, Techniques, and Procedures for Airborne Target Coordination and Attack Radar Systems*. 22 August 2012.
- ATP 3-55.12. *Multi-Service Tactics, Techniques, and Procedures for Combat Camera (COMCAM) Operations*. 12 April 2013.
- ATP 3-57.20. *Multi-Service Tactics, Techniques, and Procedures for Civil Affairs Support to Foreign Humanitarian Assistance*. 15 February 2013.
- ATP 3-60.1. *Multi-Service Tactics, Techniques, and Procedures for Dynamic Targeting*. 7 May 2012.
- ATP 3-90.90. *Army Tactical Standard Operating Procedures*. 1 November 2011.
- ATP 4-02.84. *Multi-Service Tactics, Techniques, and Procedures for Treatment of Biological Warfare Agent Casualties*. 25 March 2013.
- ATP 4-11. *Army Motor Transport Operations*. 5 July 2013.
- ATTP 2-01. *Planning Requirements and Assessing Collection*. 23 April 2012.
- ATTP 3-34.80. *Geospatial Engineering*. 29 July 2010.
- ATTP 3-39.32. *Physical Security*. 3 August 2010.
- ATTP 3-90.4. *Combined Arms Mobility Operations*. 10 August 2011.
- ATP 4-02.84. *Multi-Service Tactics, Techniques, and Procedures for Treatment of Biological Warfare Agent Casualties*. 25 March 2013.
- ATTP 4-10. *Operational Contract Support Tactics, Techniques, and Procedures*. 20 June 2011.
- ATTP 5-0.1. *Commander and Staff Officer Guide*. 14 September 2011.
- FM 1-02. *Operational Terms and Graphics*. 21 September 2004.
- FM 1-04. *Legal Support to the Operational Army*. 18 March 2013.
- FM 1-06. *Financial Management Operations*. 4 April 2011.
- FM 2-01.3. *Intelligence Preparation of the Battlefield*. 15 October 2009.
- FM 2-22.2. *Counterintelligence*. 21 October 2009.
- FM 2-22.3. *Human Intelligence Collector Operations*. 6 September 2006.
- FM 2-91.6. *Soldier Surveillance and Reconnaissance: Fundamentals of Tactical Information Collection*. 10 October 2007.
- FM 3-01.7. *Air Defense Artillery Brigade Operations*. 11 February 2010.
- FM 3-05. *Army Special Operations Forces*. 1 December 2010.
- FM 3-05.231. *Special Forces Personnel Recovery*. 13 June 2003.
- FM 3-05.301. *Psychological Operations Process Tactics, Techniques, and Procedures*. 30 August 2007.
- FM 3-06. *Urban Operations*. 26 October 2006.
- FM 3-07. *Stability Operations*. 6 October 2008.

- FM 3-09. *Fire Support*. 3 November 2011.
- FM 3-09.34. *Multi-Service Tactics, Techniques, and Procedures for Kill Box Employment*. 4 August 2009.
- FM 3-11. *Multi-Service Doctrine for Chemical, Biological, Radiological, and Nuclear Operations*. 1 July 2011.
- FM 3-13. *Inform and Influence Activities*. 25 January 2013.
- FM 3-16. *The Army in Multinational Operations*. 20 May 2010.
- FM 3-21.10. *The Infantry Rifle Company*. 27 July 2006.
- FM 3-22. *Army Support to Security Cooperation*. 22 January 2013.
- FM 3-25.26. *Map Reading and Land Navigation*. 18 January 2005.
- FM 3-34. *Engineer Operations*. 4 August 2011.
- FM 3-34.5. *Environmental Considerations*. 16 February 2010.
- FM 3-39. *Military Police Operations*. 26 August 2013.
- FM 3-39.40. *Internment and Resettlement Operations*. 12 February 2010.
- FM 3-50.1. *Army Personnel Recovery*. 21 November 2011.
- FM 3-52. *Airspace Control*. 8 February 2013.
- FM 3-53. *Military Information Support Operations*. 4 January 2013.
- FM 3-55. *Information Collection*. 3 May 2013.
- FM 3-57. *Civil Affairs Operations*. 31 October 2011.
- FM 3-60. *The Targeting Process*. 26 November 2010.
- FM 3-90-1. *Offense and Defense, Volume 1*. 22 March 2013.
- FM 3-90-2. *Reconnaissance, Security, and Tactical Enabling Tasks, Volume 2*. 22 March 2013.
- FM 3-90.31. *Maneuver Enhancement Brigade Operations*. 26 February 2009.
- FM 3-90.6. *Brigade Combat Team*. 14 September 2010.
- FM 4-02. *Army Health System*. 26 August 2013.
- FM 4-02.7. *Multi-Service Tactics, Techniques, and Procedures for Health Service Support in a Chemical, Biological, Radiological, and Nuclear Environment*. 15 July 2009.
- FM 4-30.1. *Munitions Distribution in the Theater of Operations*. 16 December 2003.
- FM 4-90. *Brigade Support Battalion*. 31 August 2010.
- FM 5-19. *Composite Risk Management*. 21 August 2006.
- FM 6-01.1. *Knowledge Management Operations*. 16 July 2012.
- FM 6-02.53. *Tactical Radio Operations*. 5 August 2009.
- FM 6-30. *Tactics, Techniques, and Procedures for Observed Fire*. 16 July 1991.
- FM 7-15. *The Army Universal Task List*. 27 February 2009.
- FM 10-1. *Quartermaster Principles*. 11 August 1994.
- FM 27-10. *The Law of Land Warfare*. 18 July 1956.
- FM 90-7. *Combined Arms Obstacle Integration*. 29 September 1994.
- FM 100-9. *Reconstitution*. 13 January 1992.
- FM 100-30. *Nuclear Operations*. 29 October 1996.

## **UNITED STATES CODE**

The United States Code is available online:

<<http://www.gpo.gov/fdsys/browse/collectionUScode.action?collectionCode=USCODE>>

Title 10, United States Code. *Armed Forces*.

Title 32, United States Code. *National Guard*.

## **WEB SITES**

Army Dictionary. <<https://jdeis.js.mil/jdeis/index.jsp?pindex=207>>

## **REFERENCED FORMS**

DA Form 2028. *Recommended Changes to Publications and Blank Forms*.

## **PRESCRIBED FORMS**

None.

**ADRP 1-02**  
**24 September 2013**

By order of the Secretary of the Army:

**RATMOND T. ODIERNO**  
*General, United States Army*  
*Chief of Staff*

Official:



**GERALD B. O'KEEFE**

*Administrative Assistant to the*  
*Secretary of the Army*  
1323203

**DISTRIBUTION:**

*Active Army, Army National Guard, and United States Army Reserve:* To be distributed in accordance with the initial distribution number (IDN) 116026, requirements for ADRP 1-02.

**This page intentionally left blank.**



