

# IMPROVED TARGET ACQUISITION SYSTEM, M41



**JULY 2005**  
**HEADQUARTERS, DEPARTMENT OF THE ARMY**

**DISTRIBUTION RESTRICTION:** Approved for public release; distribution is unlimited.

**This publication is available at  
Army Knowledge Online ([www.us.army.mil](http://www.us.army.mil)) and  
General Dennis J. Reimer Training and Doctrine  
Digital Library at (<http://www.train.army.mil>).**

# IMPROVED TARGET ACQUISITION SYSTEM, M41

## CONTENTS

	Page
<b>PREFACE</b> .....	iv
<b>CHAPTER 1. INTRODUCTION</b>	
1-1. Objectives .....	1-1
1-2. Training Strategy .....	1-1
1-3. Description.....	1-2
1-4. Technical Data.....	1-16
1-5. Capabilities .....	1-17
1-6. TOW Missiles.....	1-19
1-7. Missile Identification .....	1-20
1-8. Handling and Storage.....	1-28
1-9. Inspection.....	1-32
1-10. Gunner Notes .....	1-34
1-11. Operation Under Unusual Conditions.....	1-36
1-12. Destruction.....	1-37
1-13. Duties and Responsibilities.....	1-37
<b>CHAPTER 2. CONTROLS AND INDICATORS</b>	
2-1. Tripod Indicators.....	2-1
2-2. Traversing Unit Controls .....	2-2
2-3. Target Acquisition System Controls.....	2-12
2-4. Target Acquisition System Indicators.....	2-15
2-5. Fire Control System Controls and Indicators .....	2-35
2-6. Battery Power Source Controls and Indicators.....	2-35
<b>CHAPTER 3. MOUNTED AND DISMOUNTED OPERATIONS</b>	
Section I. Mounted Operations .....	3-1
3-1. Preventive Maintenance Checks and Services.....	3-1
3-2. Mount the ITAS on the M1121 HMMWV.....	3-1

**DISTRIBUTION RESTRICTION:** Approved for public release; distribution is unlimited.

		<b>Page</b>
	3-3.	Mounted Firing Positions ..... 3-6
	3-4.	Preparation of Missile for Firing ..... 3-7
	3-5.	Loading, Arming, and Unloading ..... 3-7
	3-6.	Target Engagement ..... 3-8
	3-7.	Troubleshooting a Tracker Engagement..... 3-12
	3-8.	Manual Engagement ..... 3-17
	3-9.	Mount the ITAS from the Dismounted (Tripod) Configuration ..... 3-19
	3-10.	Stow ITAS on M1121 from Dismounted Position ..... 3-20
Section	II.	Dismounted Operations ..... 3-27
	3-11.	Dismount Actions ..... 3-27
	3-12.	Dismounted Firing Positions ..... 3-28
	3-13.	Firing Position Actions ..... 3-28

**CHAPTER 4. FIRING TECHNIQUES**

Section	I.	Fire Control Measures ..... 4-1
	4-1.	Firing Over Water ..... 4-1
	4-2.	Firing Over Electrical Lines ..... 4-7
	4-3.	Firing in Windy Conditions ..... 4-8
	4-4.	Firing Through Smoke and Area Fires ..... 4-8
	4-5.	Firing From Bunkers and Buildings ..... 4-8
	4-6.	Clearance Requirements ..... 4-8
Section	II.	Target Engageability ..... 4-9
	4-7.	Determine if a Target is Within Range ..... 4-9
	4-8.	Determine Exposure Time ..... 4-12
	4-9.	Fire Commands ..... 4-12
	4-10.	Target Tracking ..... 4-15
	4-11.	Helicopter Engagement ..... 4-16

**CHAPTER 5. TACTICAL CONSIDERATIONS**

Section	I.	Purpose and Fundamentals ..... 5-1
	5-1.	Fundamentals of Employment ..... 5-1
	5-2.	Employment Capabilities and Limitations ..... 5-2
Section	II.	Employment in Offensive/Defensive Operations ..... 5-3
	5-3.	Offensive Operations ..... 5-3
	5-4.	Antiarmor Ambush Role ..... 5-4
	5-5.	Defensive Operations ..... 5-4
	5-6.	Other Tactical Operations ..... 5-6
	5-7.	Engagement Considerations ..... 5-7
Section	III.	Fighting Positions ..... 5-7
	5-8.	Dismounted TOW Fighting Position ..... 5-7
	5-9.	Mounted TOW Fighting Position ..... 5-9
	5-10.	Camouflage Nets ..... 5-10

	<b>Page</b>
<b>CHAPTER 6. TRAINING PROGRAM</b>	
6-1. Training Strategy .....	6-1
6-2. Commander's Training Assessment and Planning .....	6-3
6-3. Training Devices.....	6-3
6-4. Training Support Packages and Resources.....	6-6
6-5. ITAS Gunnery Training.....	6-6
<b>APPENDIX A. SAFETY .....</b>	<b>A-1</b>
<b>APPENDIX B. ITAS TRAINING DEVICES .....</b>	<b>B-1</b>
<b>APPENDIX C. FORWARD LOOKING INFRARED .....</b>	<b>C-1</b>
<b>APPENDIX D. ANTIARMOR RANGE CARD .....</b>	<b>D-1</b>
<b>APPENDIX E. SYSTEM MESSAGES, WARNINGS, AND MALFUNCTIONS.....</b>	<b>E-1</b>
<b>GLOSSARY.....</b>	<b>Glossary-1</b>
<b>REFERENCES.....</b>	<b>References-1</b>
<b>INDEX.....</b>	<b>Index-1</b>

## PREFACE

This publication provides technical information, training techniques, and guidance on the M41 Improved Target Acquisition System (ITAS). The intended users include unit leaders, trainers and designated gunners. The users will find this information invaluable in their efforts to successfully integrate this weapon system into their combat operations.

This publication applies to the Active Army, the Army National Guard (ARNG)/Army National Guard of the United States (ARNGUS), and the United States Army Reserve (USAR).

The proponent for this publication is the U.S. Army Training and Doctrine Command. The preparing agency is the U.S. Army Infantry School. Send written comments and recommendations on DA Form 2028 (Recommended Changes to Publications and Blank Forms) directly to: Commandant, U.S. Army Infantry School, ATTN: ATSH-IN, Fort Benning, GA 31905-5593. Send comments and recommendations electronically by e-mail to [doctrine@benning.army.mil](mailto:doctrine@benning.army.mil). Follow the DA Form 2028 format or submit an electronic DA Form 2028.

Unless otherwise stated, whenever the masculine gender is used, both men and women are included.

## CHAPTER 1 INTRODUCTION

*The Improved Target Acquisition System (ITAS) is the result of a technology insertion program to upgrade the current tube-launched, optically tracked, wire-guided (TOW) missile. The ITAS fires all existing and future versions of the TOW family of missiles. The ITAS provides for the integration of both the daysight and night vision sight (NVS) into a single housing and for automatic boresighting. It has embedded training (for sustainment training) and advanced built-in test/built-in-test equipment (BIT/BITE), which provides fault detection and isolation. A field tactical trainer (FTT) will replace the current TOW 2 MILES training device for force-on-force training. (The FTT will interface with future MILES replacement systems [MILES II and MILES 2000] when fielded.)*

### 1-1. OBJECTIVES

The purpose of this manual is to provide soldiers, leaders, and units with an instrument that includes the new ITAS technology with current TOW antiarmor doctrine and the ARMY transformation of CMF 11B common core skills to include the heavy antiarmor arena. Doctrine and training methodology must evolve with each technological advancement and organizational change to prepare soldiers to be combat ready on the ever-changing modern battlefield.

### 1-2. TRAINING STRATEGY

The ITAS training strategy consists of five primary components:

- Initial training.
- Sustainment training.
- Collective training.
- Force-on-force training.
- Leader training.

a. **Initial Training.** Trainers conduct initial gunner training in the unit for soldiers assigned to ITAS crews. Using the guidelines prescribed in Chapter 6 of this manual, trainers train the soldiers to successfully complete the Gunner's Skills Test (GST).

b. **Sustainment Training.** Sustainment training ensures retention of skills learned during initial training. This training takes place entirely in the unit monthly, bimonthly, quarterly, and annually.

(1) Gunners retain their skills by practicing engaging targets at least monthly. The gunner fires selected engagements from the monthly sustainment exercises using the basic skills trainer (BST). The gunner practices field engagements using the FTT every quarter.

(2) Once a quarter, the gunner completes the entire GST. If he does not perform satisfactorily, he retrain until he qualifies.

c. **Collective Training.** Collective training takes place in the unit to integrate the ITAS into the unit's overall combat power. The ITAS is integrated into collective training using the FTT.

d. **Force-On-Force Training.** Force-on-force training is conducted with the FTT during squad, platoon, company, and battalion field-training exercises (FTXs) and situational-training exercises (STXs).

e. **Leader Training.** Leader training is conducted when units are fielded with the equipment (new equipment training) and at the institution. Leaders are taught to train, maintain, and employ the ITAS during Officer and Noncommissioned Officer Education System courses (OES and NCOES, respectively) and in the Anti-Armor Leaders Course at Fort Benning, GA. This training must continue in units formally through noncommissioned officer (NCO) and officer development classes, and informally through personal initiative.

(1) ITAS leaders' training begins with the basic understanding of the ITAS, its capabilities and limitations, then moves to understanding the fundamentals of ITAS tactical employment, and includes how to integrate the ITAS into company-level training.

(2) Leaders must learn and then practice how to employ and integrate the ITAS into their units. Using tactical exercises without troops (TEWT) is an effective way to develop the leader's tactical understanding. Employing gunners with their squads helps train other squad or fire team members to perform their duties (providing security, locating targets, and so on). After-action reviews (AARs) *must* be conducted after all training exercises so ITAS security, operation, and employment considerations can be more effectively integrated into the unit training plan. (See Chapter 5 for more information on tactical employment considerations.)

### 1-3. DESCRIPTION

The system components consist of a target acquisition system (TAS), a fire control system (FCS), a battery power source (BPS), a modified M220A2 traversing unit (TU), the existing launch tube and tripod, and a modification kit for the M966 high-mobility, multipurpose, wheeled vehicle (HMMWV) that changes the vehicle to the M1121 HMMWV.

a. **Target Acquisition System.** The TAS aids the gunner in the detection, recognition, and classification of targets. It provides the gunner with passive and active range information to the target and with BIT capability. The TAS also provides a means for the gunner to control the missile during target engagement using manual and tracker methods of engagement.

(1) The TAS (Figure 1-1) provides high-power binocular viewing in both the night vision sight (NVS) and daysight modes of operation. It offers a narrow field of view (NFOV) and a wide field of view (WFOV). The TAS enables the gunner to track targets in darkness and periods of limited visibility.

(2) The TAS receives power from the BPS through the FCS in the dismounted (tripod) configuration, and uses vehicle and BPS power in the mounted (M1121) configuration.

(3) The TAS components (Figure 1-1 and Figures 1-2 and 1-3, page 1-4) are:

(a) *Vent Valve.* The vent valve is used by maintenance personnel to remove any moisture inside the TAS. This is done by purging the system with nitrogen.



(b) *Main Housing*. The main housing houses the NVS and daysight so that both are boresighted together, and it protects the sight assemblies.

(c) *Eyepiece Assembly*. The eyepiece assembly allows viewing the TAS display with both eyes.

(d) *Target Acquisition System Strap*. The TAS strap is used to lift and carry the TAS.

(e) *Front Window Cover*. The front window cover protects the front window during handling, storage, and transit.

(f) *Retainer Knob*. The retainer knob secures the TAS front sight window cover to the main housing when the sighting system is in use.

(g) *SADA II Cooler*. The standard advanced dewier assembly (SADA) II cooler cools down the NVS to its operating temperature.

(h) *Traversing Unit Connector*. The TU connector provides connections for the TAS to the TU coil cable to the FCS.

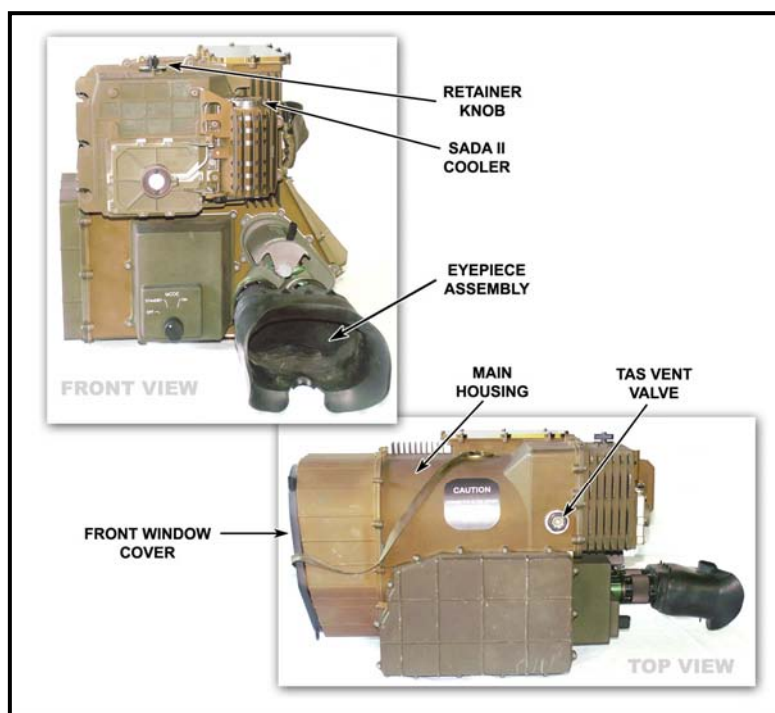
(i) *Video Test Connector*. The video test connector provides a means to connect a video device or test equipment to troubleshoot the TAS.

(j) *Index Lug Slot*. The index lug slot mates with the index lug on the TAS mount during assembly.

(k) *Target Acquisition System Transit Case*. The TAS transit case is used to store and protect the TAS when not in use (Figure 1-3, page 1-4)

(l) *Lens Cleaning Kit*. The lens cleaning kit is used to clean the lens on the NVS and daysight. It consists of pads, a bottle of detergent, and a plastic bag to store the kit.

(m) *Clip-on Filter Assemblies*. Clip-on filter assembly numbers 1 and 2 snap on over the TAS daysight lens to provide limited protection from enemy countermeasures (lasers) when using the TAS daysight. The clip-on filter assemblies are stored in the TAS transit case.



**Figure 1-1. Target acquisition system.**

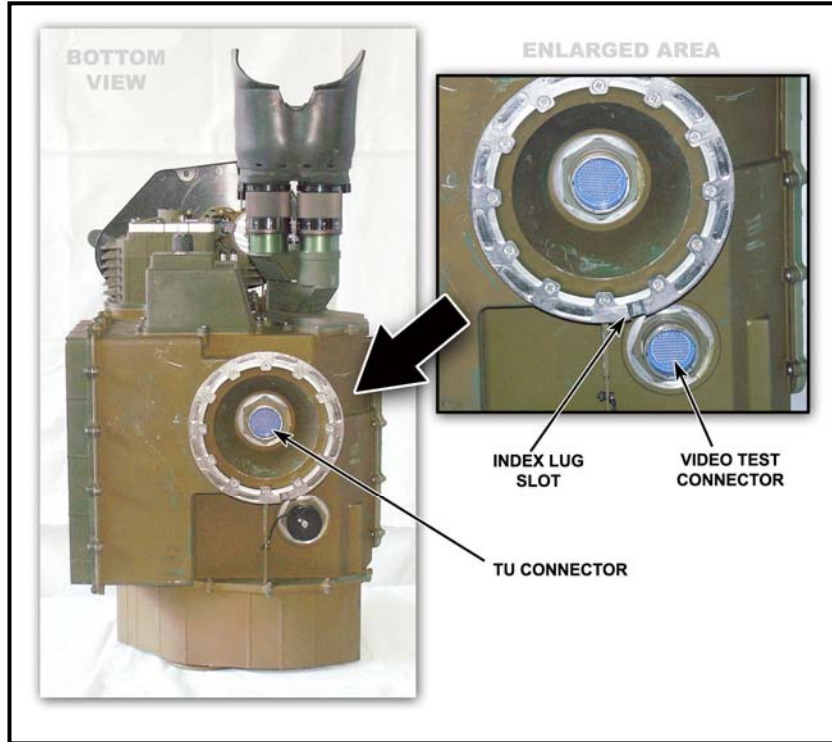


Figure 1-2. Target acquisition system (continued).

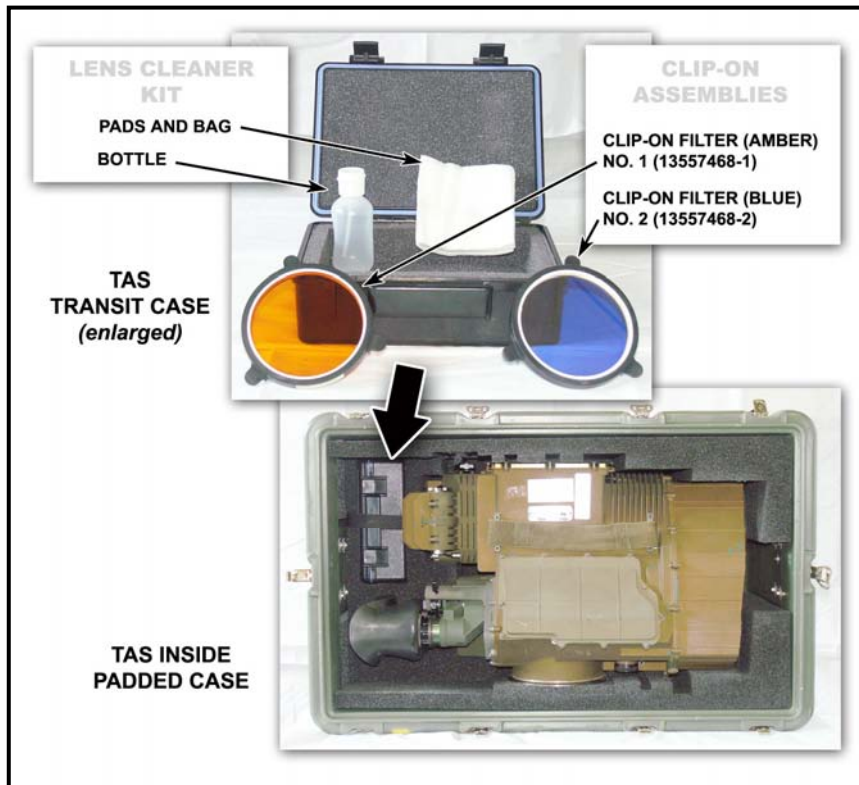


Figure 1-3. TAS transit case.

b. **Fire Control System.** The FCS provides the computer functions required by the ITAS. It tracks the target and the missile and sends commands to the missile to guide the missile to the target. The FCS also contains circuitry that allows the gunner to test the ITAS before placing it into operation. The components of the FCS (Figure 1-4, page 1-6) are:

(1) **Main Housing.** The main housing is a rugged case that protects the FCS electronics. The sides of this housing are constructed to aid heat dissipation for the enclosed electronics through cooling fins.

(2) **Power Switch.** The power switch, located under the security cover next to the J2 connector, turns on the FCS. The security cover prevents accidentally turning off the FCS.

(3) **BIT Indicator Lamp.** The BIT indicator lamp is located under the security cover next to the J5 connector on top of the FCS across from the power switch. The indicator lamp illuminates when a failure occurs within the FCS.

(4) **J1 Connector.** The J1 connector provides a connection for input power from the BPS.

(5) **J2 Connector.** The J2 connector provides electrical interface with the TU coil cable.

(6) **J3 Connector.** The J3 connector provides electrical interface with the test, measurement, and diagnostic equipment (TMDE).

(7) **J4 Connector.** The J4 connector provides electrical interface with the FTT.

(8) **J5 Connector.** The J5 connector is not used.

(8) **FCS Handle.** The FCS handle is used to lift and carry the FCS.

(9) **FCS Stow Bag.** The FCS stow bag protects the FCS when not in use and during stowed movement on the HMMWV. The interface cable is also stowed in the FCS stow bag (Figure 1-5, page 1-6).

(10) **Interface Cable.** The interface cable provides the electrical connection for power between the BPS and the FCS. The interface cable is used in the dismounted configuration (tripod) and is stowed in the FCS stow bag when the ITAS is used in the HMMWV configuration (Figure 1-5, page 1-6).

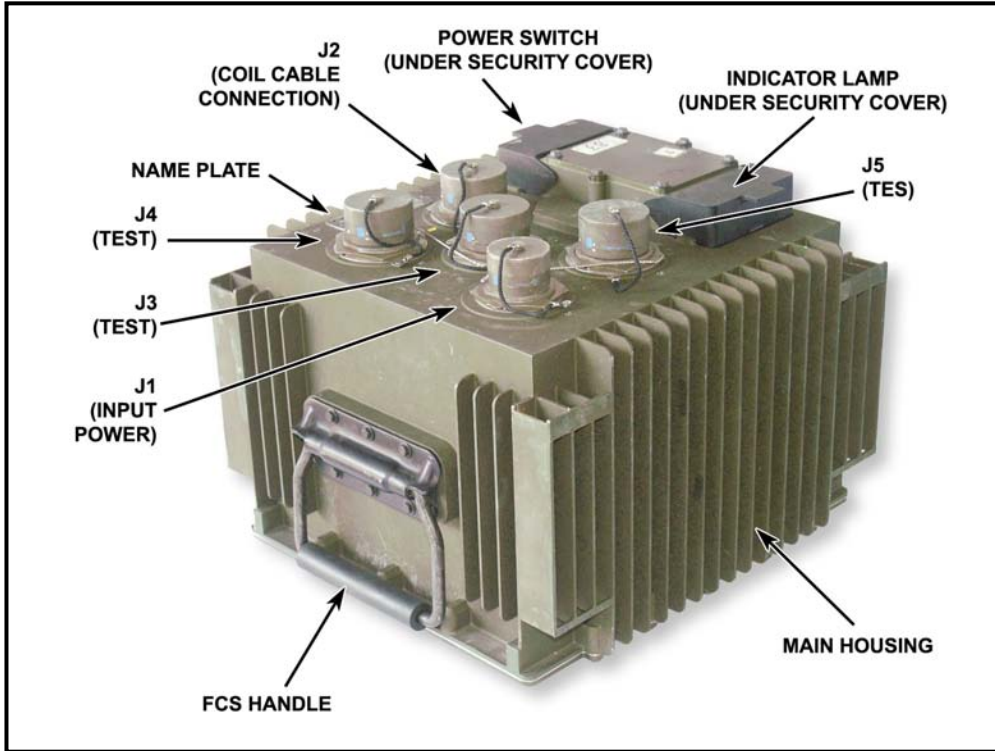


Figure 1-4. Fire control system.



Figure 1-5. FCS stow bag.

c. **Battery Power Source.** The BPS provides power for ITAS dismount operations and power conditioning for vehicle power when the ITAS is mounted on the HMMWV.

(1) The BPS uses four rechargeable, silver zinc batteries connected in series to provide power for the ITAS during dismount operations, and power conditioning for the vehicle when the ITAS is mounted on the M1121 HMMWV (Figure 1-6).

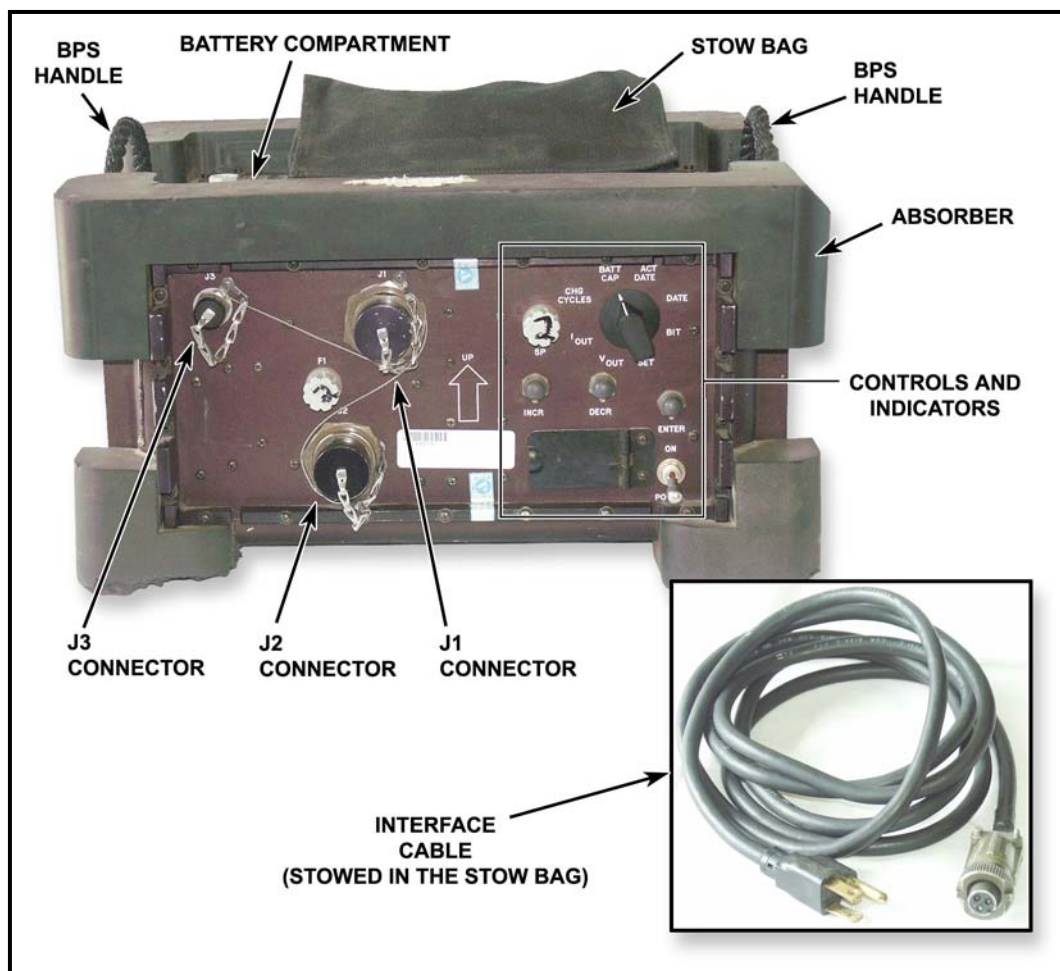


Figure 1-6. Battery power source.

(2) When mounted, a vehicle power relay automatically selects HMMWV power instead of BPS power until the vehicle batteries drop below 23.5V. It then switches to BPS power, which is indicated by BPS INTERNAL as seen on the TAS display. BIT circuitry provides the battery capacity status, the internal charger electronics status, and the battery replacement maintenance status. The results of BIT checks can be seen on the BPS display.

(3) **BPS Components.** The BPS components are as follows:

(a) **Battery Compartment.** The battery compartment contains four rechargeable, silver zinc batteries. If one of the batteries goes bad, all four batteries must be replaced.

(b) *J1 Connector.* The J1 connector provides a means to connect the vehicle power cable (VPC) to use vehicle power to operate the ITAS mounted, and to recharge the batteries.

(c) *J2 Connector.* The J2 connector provides the means to connect the FCS to the BPS.

(d) *J3 Connector.* The J3 connector provides a means to connect 115 volts (V) or 240 volts of alternating current (AC) power to recharge the BPS batteries off the vehicle, when necessary. A switch inside the BPS automatically detects which voltage is being used.

(e) *Controls and Indicators.* Controls and indicators provide interface with the gunner. (See Chapter 2 for further discussion.)

(f) *BPS Handles.* The BPS handles are used to lift and carry the BPS.

(h) *Recharge Cable.* The recharge cable is used to connect power from the 115VAC source to the J3 connector on the BPS. An adapter must be used for 240VAC.

(i) *Absorbers.* The absorbers protect the BPS.

d. **Lithium-Ion Power Source.** The lithium-ion power source (LPS) (Figure 1-7) is a direct replacement to the BPS. It has increased battery lifetime, increased system operational time (silent watch), reduced charge times, and improved vehicle power filtering. The components of the LPS are the lithium-ion battery box (LBB), the vehicle-mounted charger (VMC), and the lithium-ion AC charger (LAC).

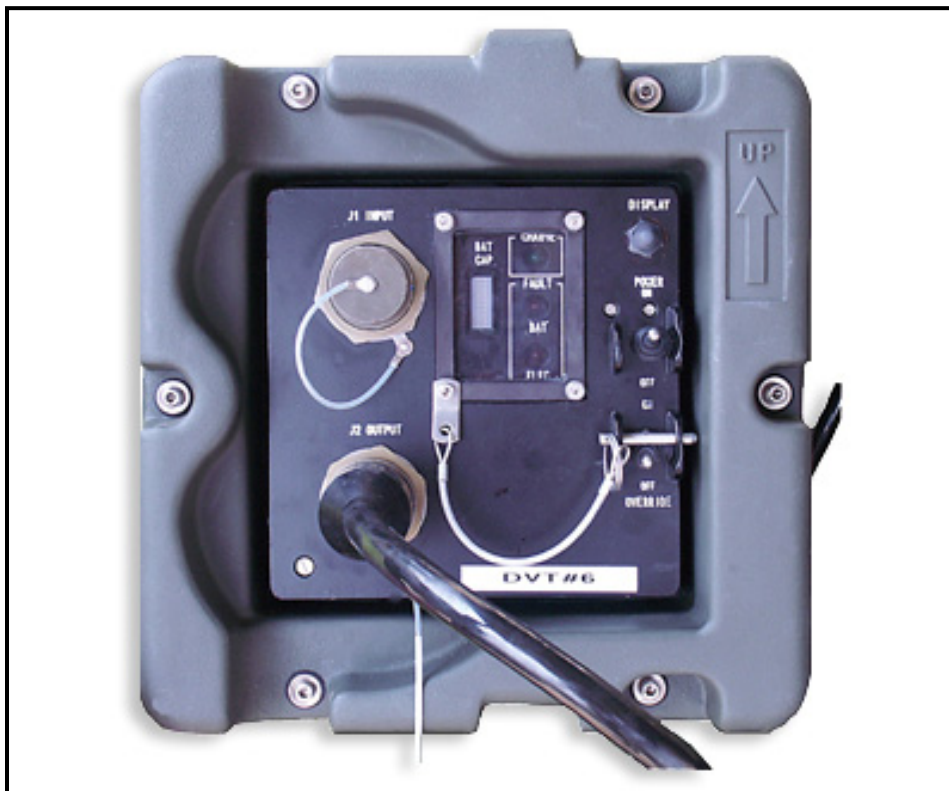


Figure 1-7. Lithium-ion power source.

(1) **Lithium-ion Battery Box.** The LBB contains the lithium-ion batteries and the battery monitoring and control circuitry.

### WARNINGS

1. Use specified charger only.
2. Do not overcharge.
3. The battery may explode if damaged, or if disposed of by fire.
4. Do not short circuit.

(2) **Vehicle-Mounted Charger.** The vehicle-mounted charger (VMC) converts vehicle power voltage to the voltage required to charge the LBB. The VMC charges at a rate approximately four times the discharge rate of the LBB. If the LBB is used for eight hours silent watch, the vehicle engine must run for two hours to recharge the LBB.

(3) **Lithium-Ion AC Charger.** The lithium-ion AC charger (LAC) converts facility 120VAC or 240VAC to the voltage required to charge the LBB. The LAC charges at a rate approximately twice the discharge rate of the LBB. If the LBB is used for eight hours silent watch and receives no engine-on vehicle charge, the LAC will take approximately four hours to recharge the LBB. The LAC draws approximately 10 amps from the facility power. Only one LAC should be connected to each power circuit.

### WARNING

**The VMC and LAC can become very hot and cause burns to personnel.**

e. **Traversing Unit.** The TU provides a stable mounting base for the TAS and launch tube along with gunner's controls to permit target tracking, missile firing, and missile guidance (Figure 1-8, page 1-10). It is mounted on the tripod or the TU adapter on the M1121 HMMWV. TU components (Figure 1-9, page 1-11) are:

(1) **Elevation Brake.** The elevation brake reduces elevation line-of-sight disturbances resulting from launch transients after missile firing.

(2) **Elevation Lock.** The elevation lock locks the TU in elevation to prevent movement during loading and movement of the HMMWV. The lock has detents in the +30-degree and -8-degree positions.

(3) **Azimuth Lock.** The azimuth lock locks the TU to prevent movement during loading and movement of the HMMWV.

(4) **Handgrips.** The handgrips (left and right) provide the gunner interface with the TAS. Switches on the left handgrip control the surveillance functions of the NVS and menu options. Switches on the right handgrip initiate track gates, initiate the laser range finder (LRF), and launch the missile. The handgrips also allow the gunner to slew the TU during surveillance and when tracking a moving target.

(5) **Coil Cable.** The coil cable provides electrical interface between the FCS and TAS through the TU.

(6) **Limiters.** Elevation and depression limiters are located on the traversing unit for use when firing from the HMMWV as safety devices. When the elevation and depression limiters are in the “UP” position and pinned, firing angle limitation will be +20 degrees and -10 degrees.

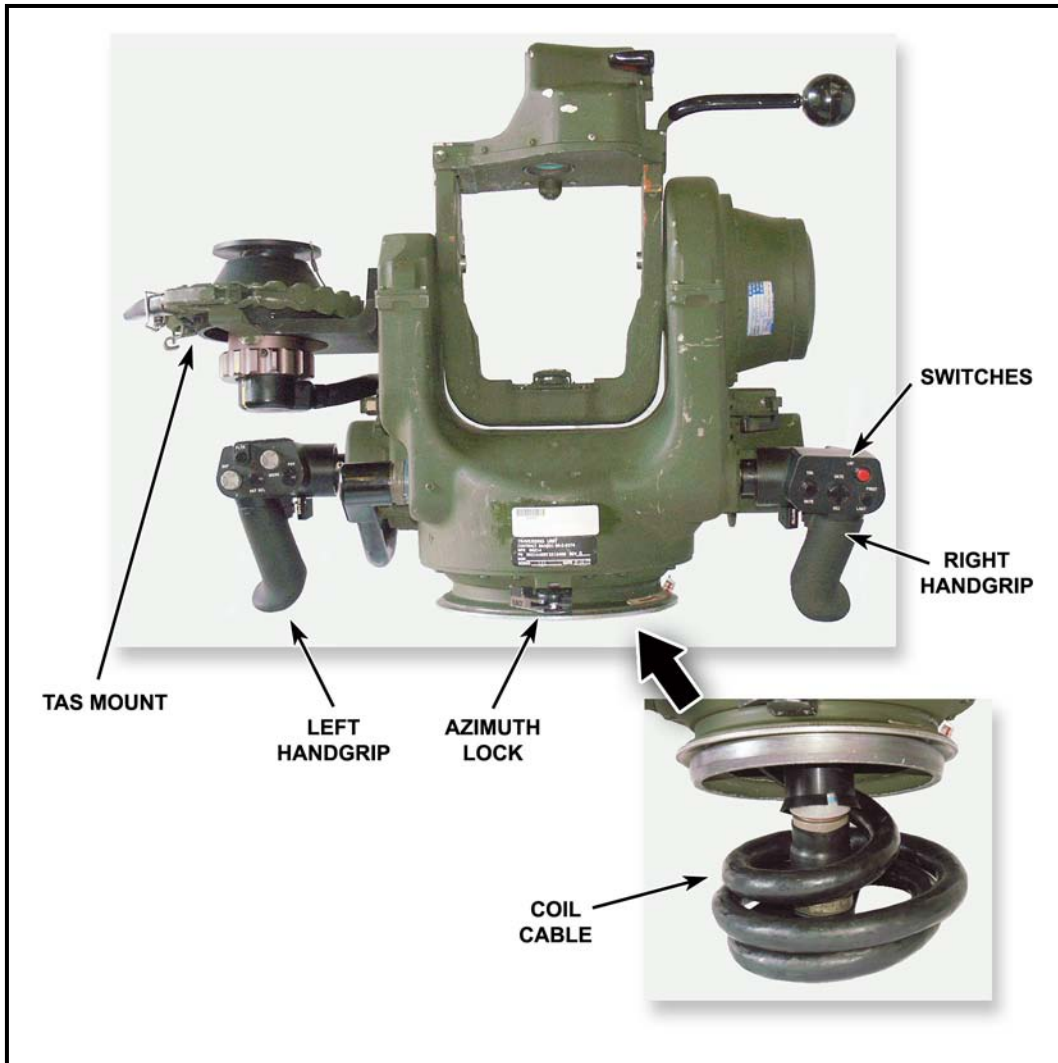
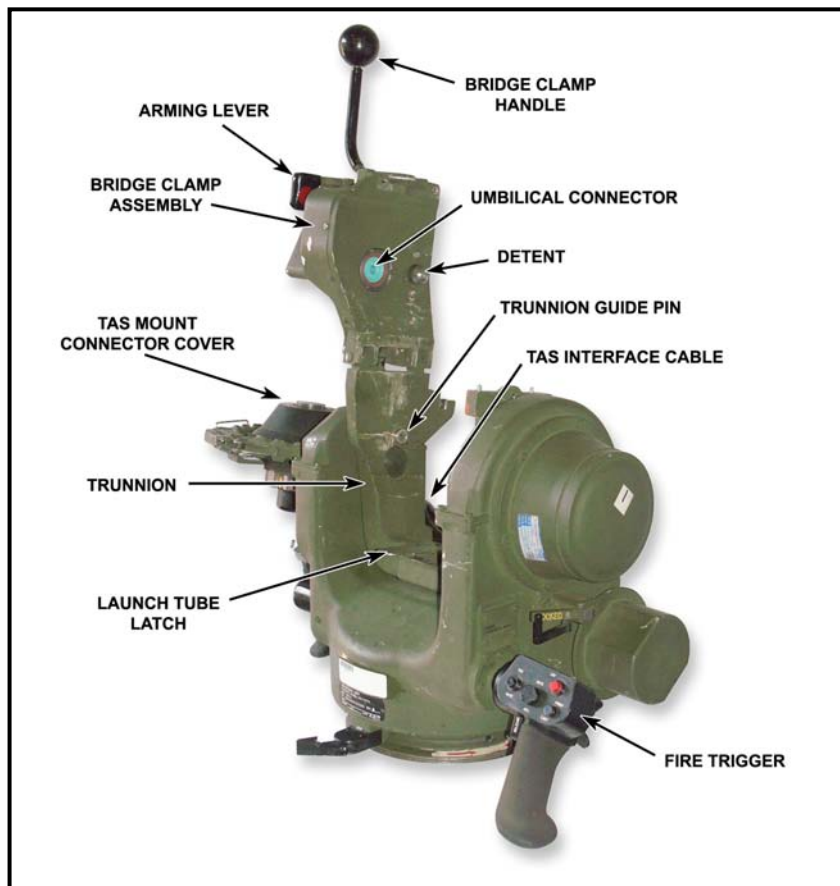


Figure 1-8. Traversing unit.





**Figure 1-9. TU components.**

(7) **TAS Mount.** The TAS mount provides mechanical and electrical connection of the TAS to the TU (Figure 1-10, page 1-12). The TAS mount components are:

(a) **TAS Mount Coupling Clamp.** The TAS mount coupling clamp is used to lock or unlock the TAS on the TAS mount.

(b) **Index Lug.** The index lug allows the TAS to be aligned properly with the TAS mount.

(c) **TAS Mount Connector.** The TAS mount connector provides electrical connection to the TAS.

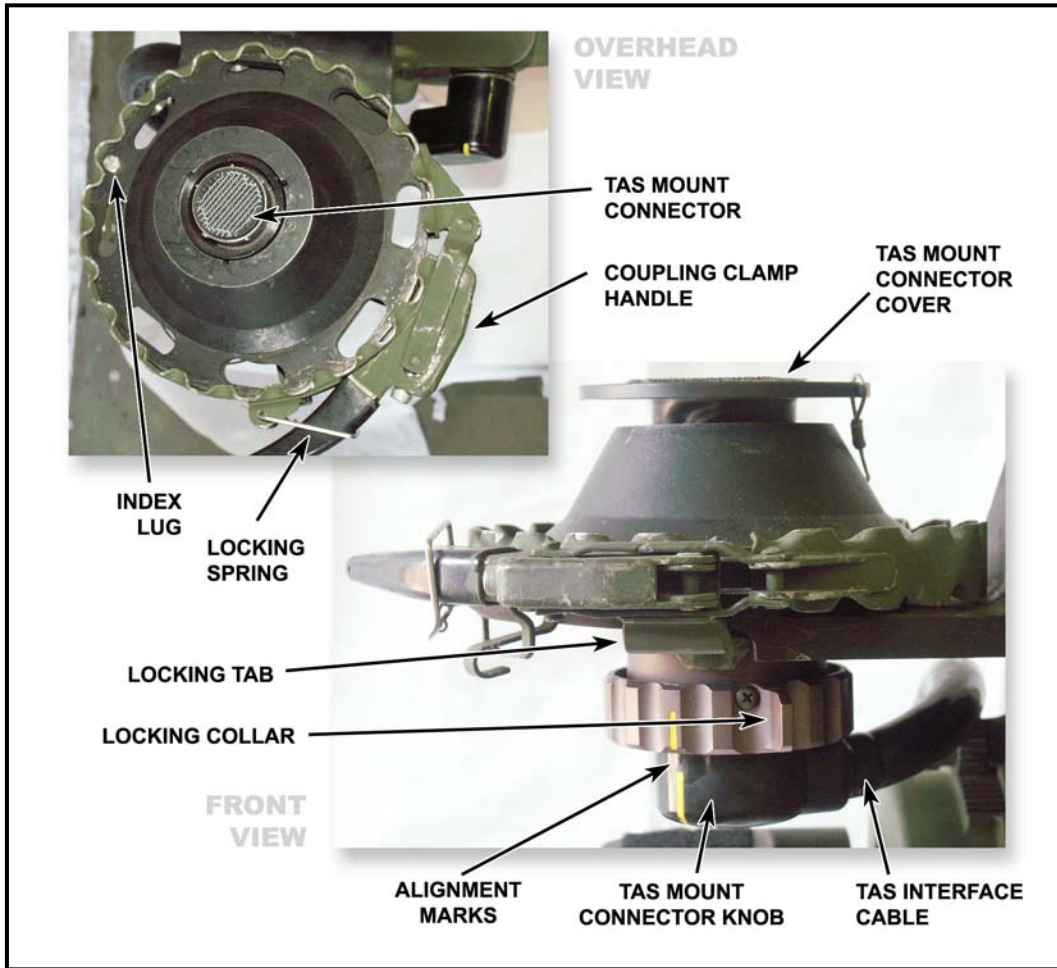
(d) **TAS Mount Connector Knob.** The TAS mount connector knob raises or lowers the TAS mount connector to connect to or disconnect from the TAS.

(e) **TAS Mount Connector Cover.** The TAS mount connector cover protects the TAS mount connector when not in use.

(f) **Locking Collar.** The locking collar prevents accidental opening of the coupling clamp handle while the TAS is connected to the TU.

(g) **Alignment Marks.** The alignment marks help the gunner orient the TAS mount connector knob.

(h) **Locking Tab.** The locking tab prevents the coupling clamp from accidentally unlocking.



**Figure 1-10. TAS mount components.**

(8) **Bridge Clamp Assembly.** The bridge clamp assembly closes down over the top of an encased missile, when one is loaded, to secure it in the TU and launch tube. The bridge clamp assembly components are:

(a) **Bridge Clamp Handle.** The bridge clamp handle locks the bridge clamp to the TU.

(b) **Arming Lever.** The arming lever arms the missile when raised and disarms the missile when lowered.

(c) **Umbilical Connector.** The umbilical connector provides electrical interface between the TU and the missile when loaded. The umbilical connector extends down about one inch when the arming lever is raised to mate with the electrical connector on the missile.

(d) **Detent.** The detent pushes the missile shear pin down through the detent boot in the missile case to allow missile firing.

(9) **Trunnion.** The trunnion is a U-shaped structure that supports the missile when loaded in the launch tube.

(10) **Fire Trigger.** The fire trigger launches the missile when squeezed.

(11) **Launch Tube Latch.** The launch tube latch secures the launch tube to the trunnion.

(12) **TAS Interface Cable.** The TAS interface cable provides an electrical interface between the TAS mount and the TU.

(13) **Trunnion Guide Pins.** The trunnion guide pins mate with trunnion guides on the enclosed missile.

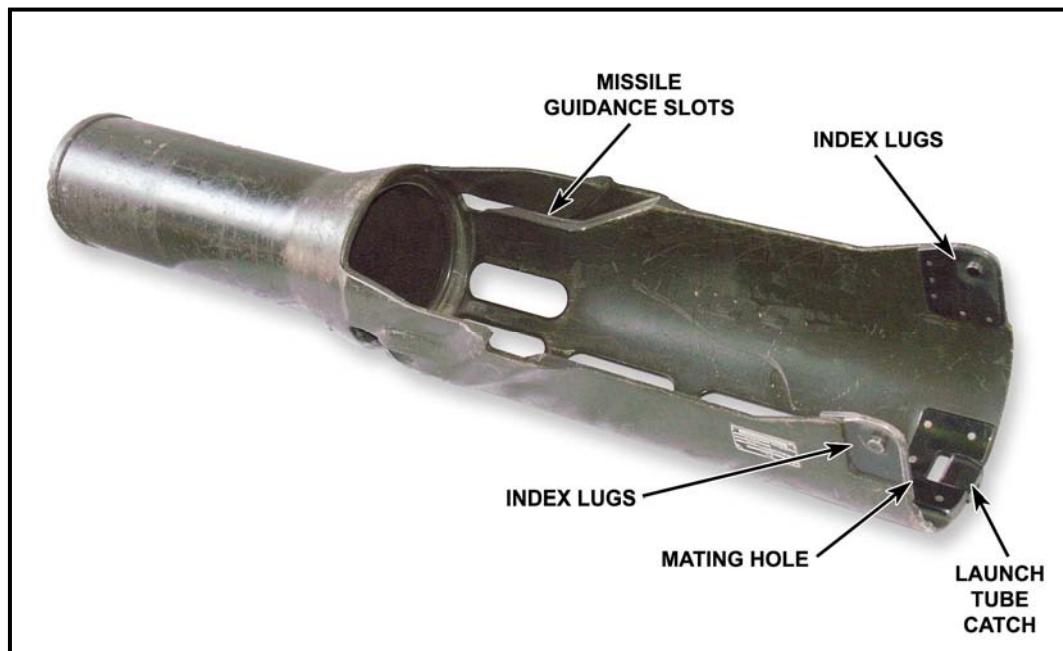
e. **Launch Tube.** The launch tube seats the forward end of the enclosed missile and provides mechanical guidance for the first part of the missile flight (Figure 1-11). The launch tube components and their functions are:

(1) **Missile Guidance Slots.** The missile guidance slots guide the missile into position in the launch tube.

(2) **Index Lugs.** The index lugs align the launch tube to the TU.

(3) **Mating Hole.** The TU locating pin fits into the launch tube mating hole during launch tube installation.

(4) **Launch Tube Catch.** The launch tube catch locks the launch tube into place.



**Figure 1-11. Launch tube.**

f. **Tripod.** The ITAS tripod (Figure 1-12, page 1-14) provides a stable platform for the ITAS during dismount operations (Figure 1-13, page 1-15). The major components of the tripod are the coupling clamp, level indicators, and tripod legs.

(1) **Coupling Clamp.** The coupling clamp locks the TU to the tripod. The coupling clamp handle activates the coupling clamp. The locking spring prevents accidental opening of the coupling clamp handle.

(2) **Level Indicators.** Level indicators allow the gunner to level the tripod when set up on uneven terrain.

(3) **Tripod Legs.** The tripod legs provide a means to set up the tripod. The three legs on the tripod each have the following components:

(a) *Foot*. The foot makes the tripod work on various types of terrain and provides a secure footing when other components are mounted on the TU.

(b) *Anchor Claw*. The anchor claw prevents the tripod legs from shifting side to side on soft ground.

(c) *Detent Stop Lever*. The detent stop lever releases the mechanism from detent stops. Press and release this lever to adjust the tripod legs.

(d) *Lock Handle*. The lock handle locks the tripod legs at any height regardless of detent stop position.

(e) *Detent Stop Markings*. These markings on each leg denote three adjustable height positions for the tripod assembly. The detent will automatically “click” into position as the gunner lifts up on the tripod body to adjust the height of the tripod.

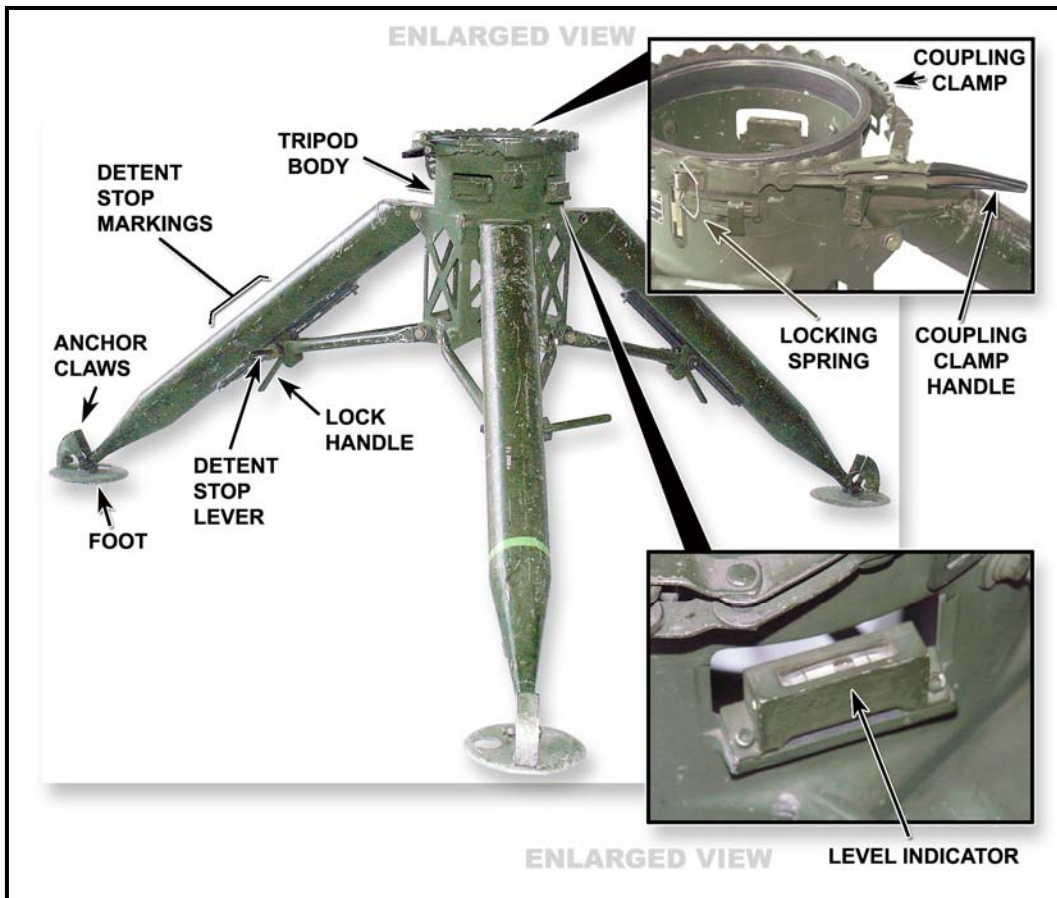
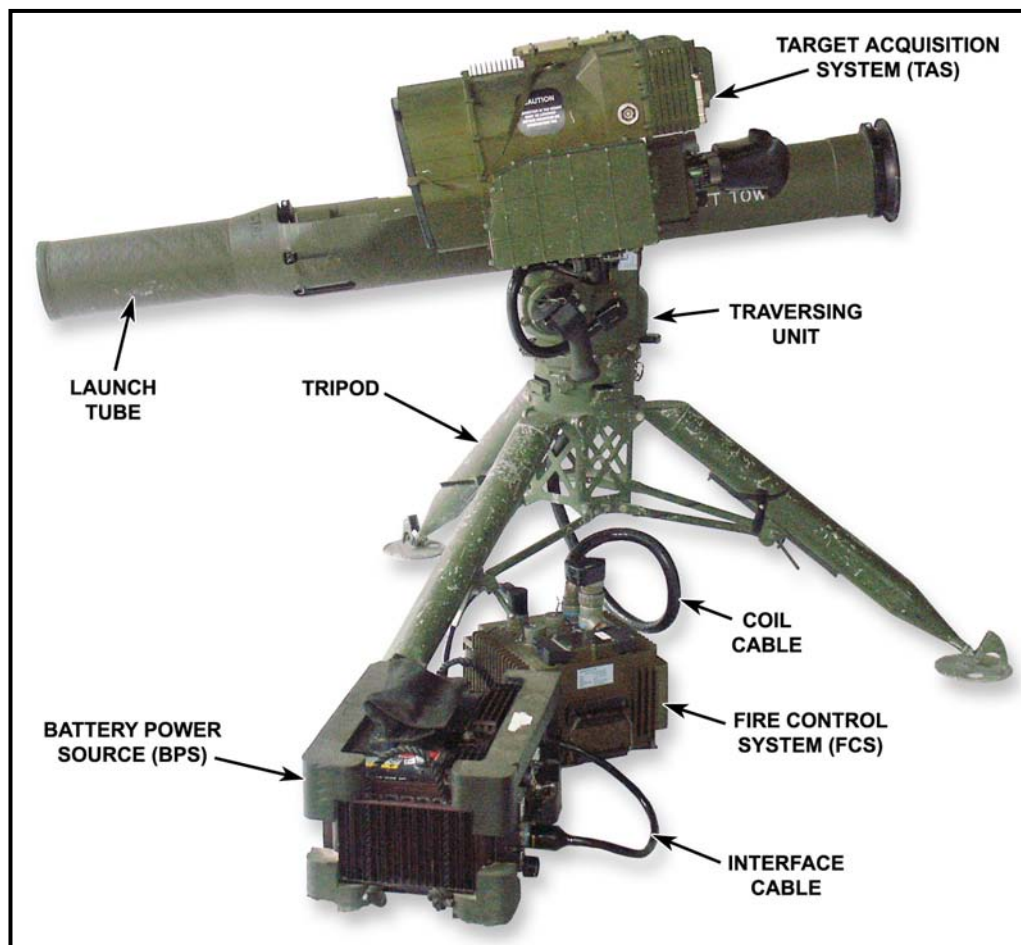


Figure 1-12. ITAS tripod.



**Figure 1-13. ITAS tripod configuration.**

g. **Encased Missile.** The encased missile is the ammunition that is fired from the ITAS. The encased missile components (Figure 1-14, page 1-16) and their functions are as follows:

(1) **Forward Handling Ring and Quick Release Clamp.** The forward handling ring and quick release clamp provide missile protection during storage and movement.

(2) **Indexing Lugs.** The indexing lugs mate with the missile guidance slots in the launch tube.

(3) **Trunnion Guide.** The trunnion guide mates with the trunnion guide pins on the TU to lock the missile in place.

(4) **Rear Handling Ring.** The rear handling ring provides missile protection during storage and movement.

(5) **Diaphragm.** The diaphragm houses the humidity indicator and acts as a watertight seal.

(6) **Humidity Indicator.** The humidity indicator shows if the missile has water or humidity in it.

(7) **Electrical Connector.** The electrical connector mates with the TU umbilical connector to provide all electrical signals.

(8) **Protective Cover.** The protective cover protects the electrical connector.

(9) *Detent Boot*. The detent boot protects the shear pin.



Figure 1-14. Encased missile components.

1-4. TECHNICAL DATA

Table 1-1 shows the technical data and characteristics of the ITAS.

<b>TAS Technical Data</b>	<b>AN/T55-12</b>
Weight (average w/out transit case and cleaning kit)	54.5 lbs.
Dimensions:	
Length	26.0 in. (includes eye cup)
Width	15.5 in.
Height	15.5 in.
<b>FCS Physical Characteristics</b>	<b>AN/TSW-15</b>
Weight (average w/out carry bag)	36 lbs.
Dimensions:	
Length	12.0 in.
Width	10.0 in.
Height	9.0 in.

Table 1-1. Technical data and characteristics of ITAS.

<b>BPS Physical Characteristics</b>	<b>PP-8450/TSS</b>
Weight with battery	57.5 lbs.
Dimensions:	
Length	14.0 in.
Width	18.0 in.
Height	9.5 in.
<b>Launch Tube Physical Characteristics</b>	<b>M22</b>
Weight	11 lbs.
Dimensions:	
Length	42.0 in.
Width	9.0 in.
Height	8.0 in.
<b>Tripod Physical Characteristics</b>	<b>M159A1</b>
Weight	22 lbs.
Dimensions:	
Length	42.5 in.
Width	13.5 in.
Height	13.5 in.

**Table 1-1. Technical data and characteristics of ITAS (continued).**

### 1-5. CAPABILITIES

The ITAS can fire all existing and future TOW missiles. It can operate day or night and in all weather conditions enabling the gunner to see the target through either the daysight or NVS. The system includes an LRF to accurately determine the range to the target. The ITAS has the following enhanced capabilities over the M220A2.

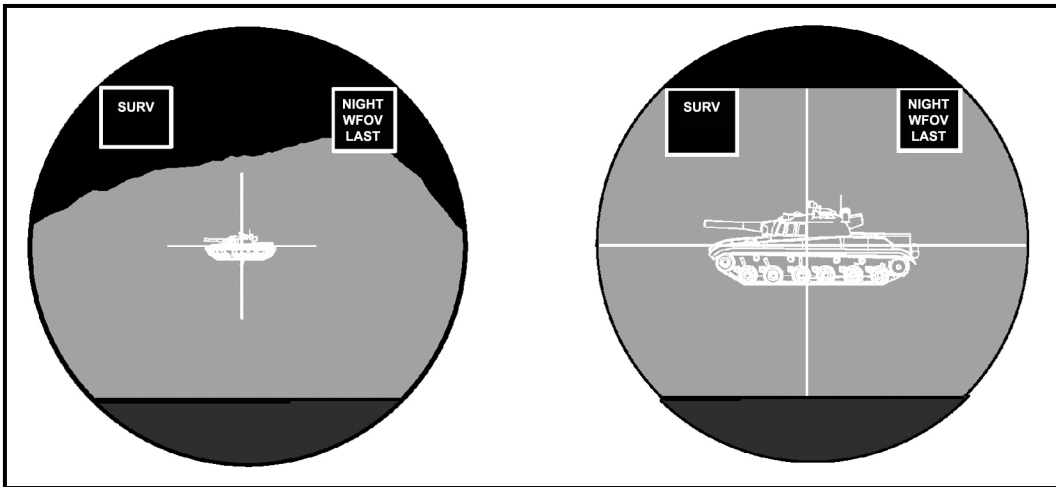
- Aided target tracking (ATT) and an elevation brake provide the ITAS gunner with an improved probability of a hit over the M220A2.
- The ITAS performs better in degraded battlefield conditions (smoke, limited visibility, and so on).
- Built-in gunner initiated boresight provides for better accuracy and faster boresighting.
- An acquisition system for viewing both the daysight and NVS is used so the gunner does not have to move his head from sight to sight as with the M220A2.
- Built-in test software can identify system failures and display them in the TAS display.
- An eye-safe LRF and passive ranging provide the gunner improved means of determining range to target.
- The ITAS operates at altitudes up to 3,050 meters (10,000 feet).
- The ITAS has an improved first round hit capability against stationary or moving targets.
- The crew (driver, gunner, and squad leader) can carry all components, short distances, to a dismounted firing position.
- a. The ITAS has two sights with two fields of view each for a total of four different combinations: NVS wide field of view (WFOV), NVS narrow field of view (NFOV), daysight wide field of view (DWFOV), and daysight narrow field of view (DNFOV).

(1) **Night Vision Sight (NVS).** The NVS allows the gunner to view the target area in wide (4x) or narrow (12x) fields of view. (Figure 1-15 shows examples of the difference between these fields of view.)

(a) **WFOV.** The WFOV covers an 8-degree area compared to the narrow 2.7-degree field of view. The gunner uses the WFOV to scan a large general target scene for potential targets. However, he will be able to distinguish very little detail about any object he sees at long ranges.

(b) **NFOV.** The gunner uses the NFOV primarily to recognize and engage targets, and perform battle damage assessment (BDA). It covers one-third of the target area seen by WFOV. Using the NFOV, the gunner can see target details more clearly, which allows him to determine whether or not an object is a target and possibly identify it as friendly or enemy.

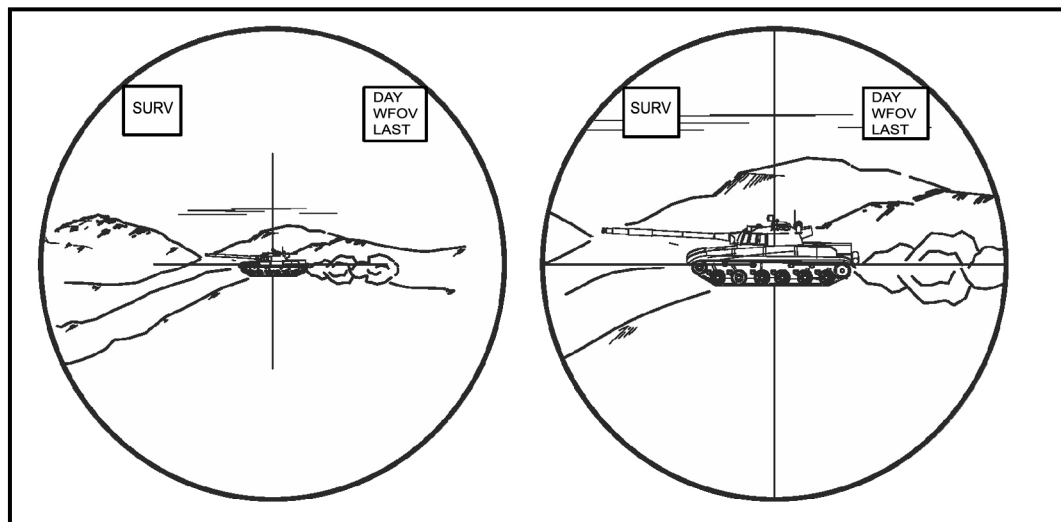
(c) **Zoom.** Zoom doubles the magnification of the NVS when it is in surveillance mode. WFOV doubles from 4x to 8x magnification and NFOV doubles from 12x to 24x magnification. If the track gates are selected or the missile is armed, the zoom will automatically revert to the NVS FOV listed in the state box.



**Figure 1-15. ITAS NVS fields of view.**

(2) **Daysight.** The daysight provides two fields of view with the same power as the NVS fields of view (Figure 1-16).





**Figure 1-16. ITAS daysight fields of view.**

b. **Aided Target Track Capability.** The ITAS has a unique feature called ATT. Using ATT capability, gunners can smooth out the normal jitter associated with the TOW when tracking targets at maximum range and increase their probability of a target hit. The ATT capability is only available in the NVS mode. (If the gunner must engage a target using the daysight, he must manually track the target. Using manual track, the gunner must keep the crosshairs on the center of visible mass until the missile impacts.) Using ATT, the gunner activates his track gates, places them around the target, adjusts them to target size, and locks them on the target. The track gates will stay around the target and follow the target (if moving) as long as the gunner keeps the target in the field of view. However, the gunner must keep the crosshairs centered on the target when the system is armed, at trigger pull, and during missile flight. ATT will cause the missile to fly to the center of mass within the track gates.

## 1-6. TOW MISSILES

The TOW missile used with any TOW weapon system is encased in a launch container that is put into the TOW launcher when ready for use. The TOW missile comes in many attack types (BGM series) containing a high-explosive warhead and several practice types (BTM series), which have an inert warhead. Missile size and weight data are summarized in Table 1-2, (page 1-20) (all values are nominal). The various types of missiles are identified in Table 1-3 (pages 1-21 and 1-22). (TM 9-1410-470-34 provides detailed information on the operation and maintenance of the TOW missile.)

	<b>Guided Missile, Surface Attack BGM-71-Series</b>	<b>Guided Missile, Practice (Inert Warhead, Live Motors) BTM-71-Series</b>
Length	50.6 inches (128.4 centimeters)	50.6 inches (128.4 centimeters)
Diameter	8.6 inches (21.9 centimeters)	8.6 inches (21.9 centimeters)
Volume	1.7 cubic feet (48.1 liters)	1.7 cubic feet (48.1 liters)
Weight*		
-71A-Series	54.2 pounds (24.6 kilograms)	54.2 pounds (24.6 kilograms)
-71C-Series	54.2 pounds (24.6 kilograms)	54.2 pounds (24.6 kilograms)
-71D-Series	61.3 pounds (27.9 kilograms)	61.3 pounds (27.9 kilograms)
-71E-Series	64.1 pounds (29.1 kilograms)	64.1 pounds (29.1 kilograms)
-71F-Series	63.9 pounds (29.0 kilograms)	
-71H-Series	66.1 pounds (30.0 kilograms)	
<b>EXPLOSIVE WEIGHT</b>		
Warhead		
-71A-Series	5.3 pounds (2.4 kilograms)	None
-71C-Series	4.5 pounds (2.0 kilograms)	
-71D-Series	6.9 pounds (3.1 kilograms)	
-71E-Series	7.0 pounds (3.2 kilograms)	
-71F-Series	5.2 pounds (2.4 kilograms)	
-71H-Series	7.0 pounds (3.2 kilograms)	
Launch motor	1.2 pounds (0.55 kilogram)	1.2 pounds (0.55 kilogram)
Flight motor		
-71A-Series	5.8 pounds (2.5 kilograms)	5.8 pounds (2.5 kilograms)
-71C-Series	5.8 pounds (2.5 kilograms)	5.8 pounds (2.5 kilograms)
-71D-Series	7.1 pounds (3.2 kilograms)	7.1 pounds (3.2 kilograms)
-71E-Series	7.1 pounds (3.2 kilograms)	7.1 pounds (3.2 kilograms)
-71F-Series	7.1 pounds (3.2 kilograms)	7.1 pounds (3.2 kilograms)
-71H-Series	7.1 pounds (3.2 kilograms)	7.1 pounds (3.2 kilograms)
*Overpack shipping container weighs 35.3 pounds (16.0 kilograms)		

**Table 1-2. TOW encased missile size and weight chart.**

**1-7. MISSILE IDENTIFICATION**

The TOW missile family consists of several distinct missile types, each designed to defeat a specific target. It is important that the crew of a TOW firing platform can identify the various types. The following paragraphs describe each of the TOW missile types and provide information that will allow the crew to identify them.

**NOTE:** The short model number, such a 71A, is used in the identification figures. Dash extensions may be added to form the complete model number. The part numbers, NSN, and complete model numbers for each missile type are shown in Table 1-3.

Type/Model No.	NSN	Part No.	Remarks
<b>WITH ANALOG ELECTRONIC UNIT</b>			
STD/BGM-71A	1410-00-087-1521	10189999	3,000 meter basic: all code N
STD/BGM-71A-2	1410-01-139-1512	13100906	3,000 meter basic w/MOIC
STD/BGM-71A-2A	1410-01-257-6493	13296259	3,000 meter basic w/CLM & MOIC
STD/BGM-71A-4B	NONE	13296438	3,000 meter basic w/CLM & MOIC/ MOIC E
STD/BTM-71A	1410-00-087-1527	10190149	3,000 meter practice
STD/BTM-71A-2	1410-01-137-9976	13100908	3,000 meter w/MOIC & practice warhead
STD/BTM-71A-2A	1410-01-257-6494	13296260	3,000 meter w/MOIC, practice warhead & new non-CLM
STD/BTM-71A-2B	1410-01-309-8301	13296486	3,000 meter w/MOIC, practice warhead & CLM
Type/Model No.	NSN	Part No.	Remarks
EXT/BGM-71A-1	1410-01-007-2507	11500160	3,750 meter basic
EXT/BGM-71A-3	1410-01-181-6032	13100902	3,750 meter basic w/MOIC
EXT/BGM-71A-3A	1410-01-257-7584	13296261	3,750 meter basic w/MOIC & CLM
EXT/BGM-71A-5B	1410-01-406-9252	13296436	3,750 meter basic w MOIC/MOIC E
EXT/BTM-71A-1	1410-01-007-2508	11500162	3,750 meter practice
EXT/BTM-71A-1B	1410-01-309-8302	13296489	3,750 meter practice w/CLM
EXT/BTM-71A-3	1410-01-180-6791	13100904	3,750 meter practice w/MOIC
EXT/BTM-71A-3A	1410-01-257-7585	13296262	3,750 meter practice w/MOIC & CLM
ITOW/BGM-71C	1410-01-106-8514	13060893	ITOW
ITOW/BGM-71C-1	1410-01-180-6790	13100900	ITOW w/MOIC
ITOW/BGM-71C-1A	1410-01-257-7583	13296263	ITOW w/MOIC & CLM
ITOW/BGM-71C-2B	1410-01-309-8303	13296476	ITOW w/CLM
ITOW/BGM-71C-3B	1410-01-406-9251	13296440	ITOW w/MOIC E
TOW 2/BGM-71D	1410-01-135-2092	13194422	TOW 2
TOW 2/BGM-71D-1B	1410-01-301-0815	13296474	TOW 2 w/CLM
TOW 2/BGM-71D-2B	NONE	13296597	TOW 2 w/CLM & IMOIC
TOW 2/BTM-71D-1B	1410-01-303-5172	13296497	TOW 2 w/practice warhead & CLM
TOW 2/BTM-71D-2B	NONE	13296596	TOW 2 w/practice warhead, CLM, & IMOIC
TOW 2/BTM-71D-5	1410-01-469-8929	13589825	TOW 2 w/IMOIC
TOW 2A/BGM-71E	1410-01-229-9948	13218444	TOW 2A
TOW 2A/BGM-71E-1B	1410-01-300-0254	13296473	TOW 2A w/CLM
TOW 2A/BGM-71E-2B	NONE	13296598	TOW 2A w/CLM & IMOIC
<b>WITH DIGITAL ELECTRONIC UNIT</b>			
EXT/BTM-71A-3B	1410-01-313-5364	13296324	3,750 meter basic w/CLM
ITOW/BGM-71C-4B	1410-01-313-5365	13296321	ITWO w/CLM
TOW 2/BGM-71D-3B	1410-01-313-5366	13296322	TOW 2 w/CLM
TOW 2A/BGM-71E-3B	1410-01-313-5367	13296323	TOW 2A w/CLM
TOW 2A/BGM-71E-4B	1410-01-370-2288	13426448	TOW 2A w/spliceless harness
TOW 2A/BGM-71E-5B	1410-01-379-8260	13426588	TOW 2A Navy missiles (ISD)
TOW 2A/BGM-71E-6B	1410-01-379-8253	13456991	TOW 2A hero case (green)
TOW 2A/BTM-71E-2B	1410-01-343-8924	13367100	TOW 2A w/practice warhead & CLM
TOW 2A/BTM-71E-3B	1410-01-370-2292	13456963	TOW 2A w/spliceless harness
TOW 2B/BGM-71F	1410-01-322-5444	13296442	TOW 2B
TOW 2B/BGM-71F-1	1410-01-370-2289	13426441	TOW 2B w/spliceless harness
TOW 2B/BGM-71F-1A	1410-01-473-0281	13457302	TOW 2B w/spliceless harness & GEN 1

Table 1-3. TOW missile identification.

TOW 2B/BGM-71F-3	1410-01-503-6776	13608643	TOW 2B AERO; 4,000 meters
TOW 2B/BGM-71F-4	1410-01-603-6774	13608669	TOW 2B AERO w/GEN 1; 4,000 meters
TOW 2B/BGM-71F-5	1410-01-503-6779	13608697	TOW 2B AERO w/GEN 3A; 4,000 mtrs
TOW 2B/BGM-71F-6	1410-01-511-2655	13608720	TOW 2B AERO w/GEN 2; 4,000 meters
TOW BB/BGM-71H	110-01-500-0245	13607748	Bunker-buster warhead

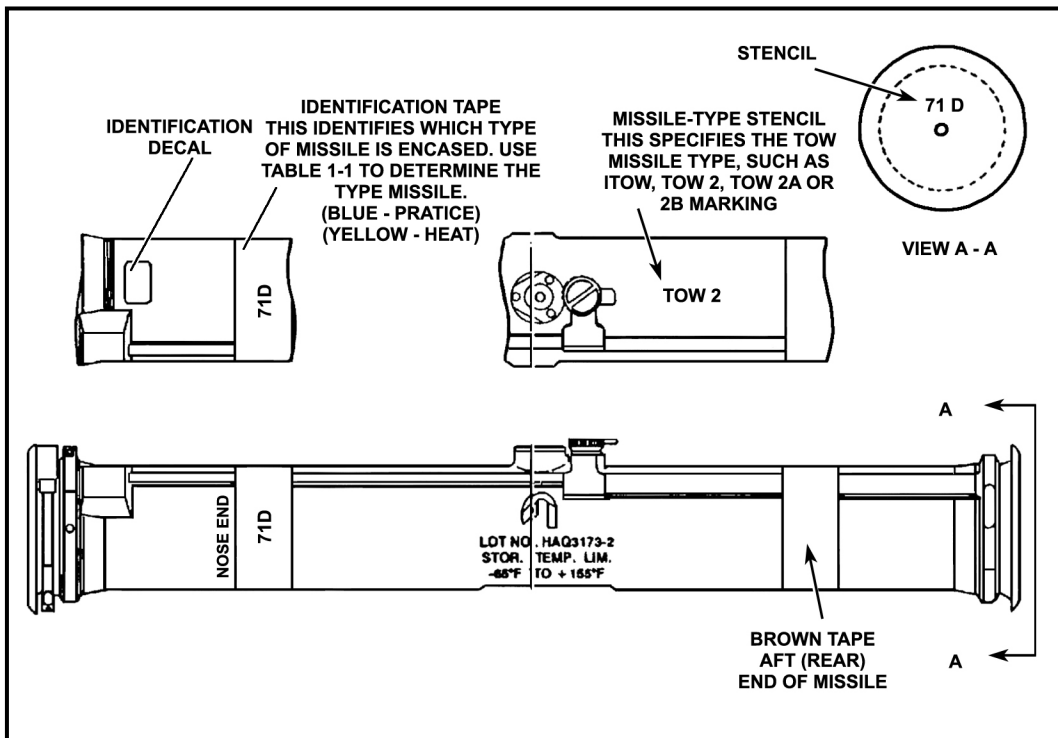
CLM—coated launch motor  
 MOIC—missile ordnance inhibit circuit  
 MOIC E—missile ordnance inhibit circuit enhancement (requires MOIC)  
 IMOIC—improved missile ordnance inhibit circuit (replaces MOIC/MOIC E)

NOTE: BGM model number prefix indicates HEAT warhead.  
 BTM model number prefix indicates practice warhead.

**Table 1-3. TOW missile identification (continued).**

a. **TOW Basic (BGM- and BTM-71A-Series)** (Figure 1-17). This is the original TOW missile that was developed in the 1960's. It was originally designed with a range of 3,000 meters, but was extended to 3,750 meters, which is the range of all of the missiles except those with the AERO designation. The basic TOW has a 6-inch diameter body with a 5-inch diameter warhead, which has a crush switch (ogive) at the nose. The crush switch activates upon contact with the target, allowing the warhead to detonate. Both HEAT and practice warheads are available.

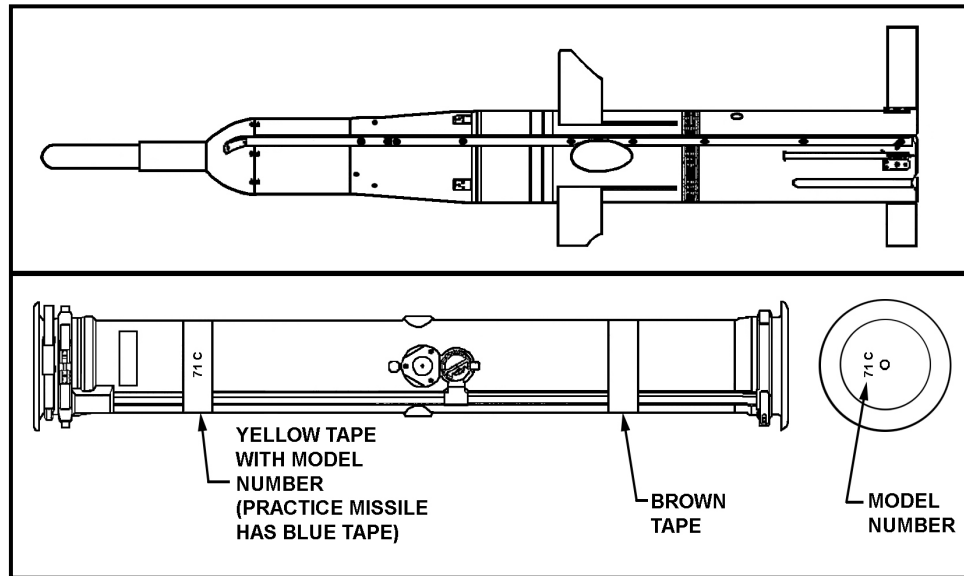
**NOTE:** Few basic TOW missiles remain in the U.S. Army inventory, and they are used for training only.



**Figure 1-17. TOW basic missile with identification.**

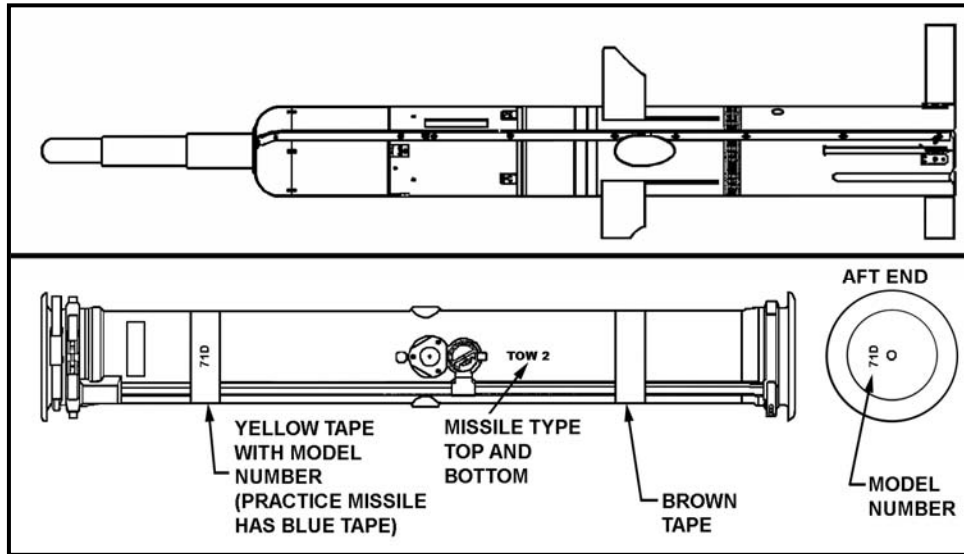
b. **Improved TOW (ITOW, BGM- and BTM-71C-Series)** (Figure 1-18). The ITOW was the first TOW missile with a stand-off probe. It was designed to provide better penetration of the armor while using the 5-inch warhead. There is a crush switch in both the probe and the curved nose surface behind the probe, which allows the warhead to detonate upon impact with the target. The ITOW missile has a range of 3,750 meters and both HEAT and practice warheads are available.

**NOTE:** Few of the ITOW missiles remain in the U.S. Army inventory, and they are used for training only.



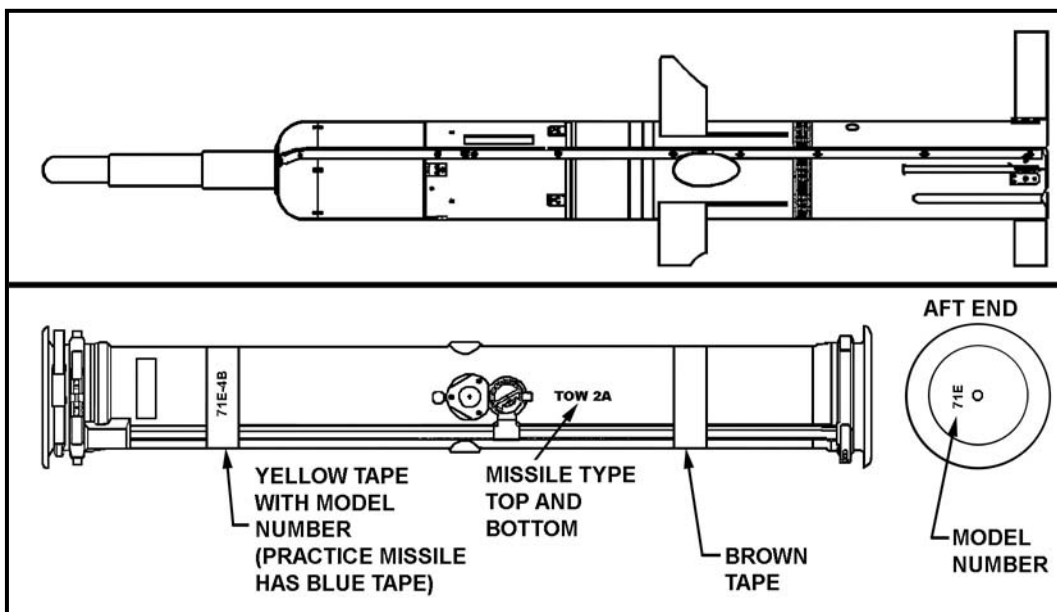
**Figure 1-18. ITOW missile and identification.**

c. **TOW 2 (BGM- and BTM-71D-Series)** (Figure 1-19, page 1-24). The TOW 2 missile (and the remaining TOW missiles discussed) has an enhanced tracking link and a 6-inch diameter warhead. The enhanced tracking link allows it to be guided successfully under a variety of environmental conditions, including rain and smoke. The 6-inch diameter warhead allows more explosive to be contained within the warhead. The TOW 2 warhead also has a probe with a crush switch that allows for better penetration of the warhead charge. As with ITOW, both the probe and the curved surface of the nose behind the probe are crush switches, which allows the warhead to detonate upon impact with the target. The TOW 2 missile has a range of 3,750 meters, and both HEAT and practice warheads are available.



**Figure 1-19. TOW 2 missile and identification.**

d. **TOW 2A (BGM- and BTM-71E-Series)** (Figure 1-20). The TOW 2A looks similar to the TOW 2 missile. The difference is contained in the tip of the probe. The probe contains a tip-charge, which detonates when the probe impacts the target through the use of a crush switch. After a short delay, the main charge detonates. The tip-charge is designed to remove the reactive armor of some armored vehicles, thereby allowing the main charge to penetrate the vehicle itself. The TOW 2A warhead is the full 6-inch diameter of the body. The TOW 2A missile has a range of 3,750 meters, and both HEAT and practice warheads are available.

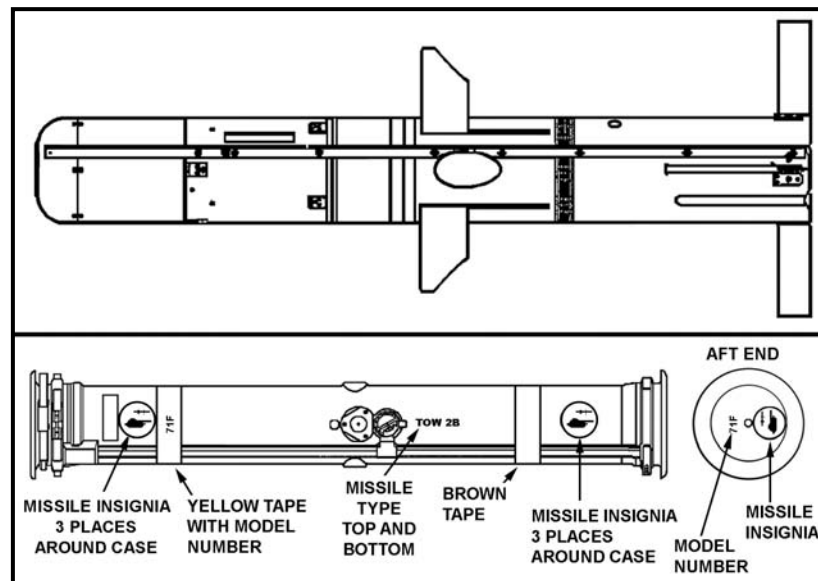


**Figure 1-20. TOW 2A missile and identification.**

e. **TOW 2B 9BGM-71F and 71F-1-Series)** (Figure 1-21). With the advent of multiple layers of reactive armor on target vehicles, the TOW 2B was developed to attack the target from the top (fly-over-shoot-down [FOSD]). The TOW 2B contains two sensors; one identifies the iron in the armored vehicle, and the other optically determines when the target is below the missile. Both sensors are required to differentiate the target from the ground the missile is flying over.

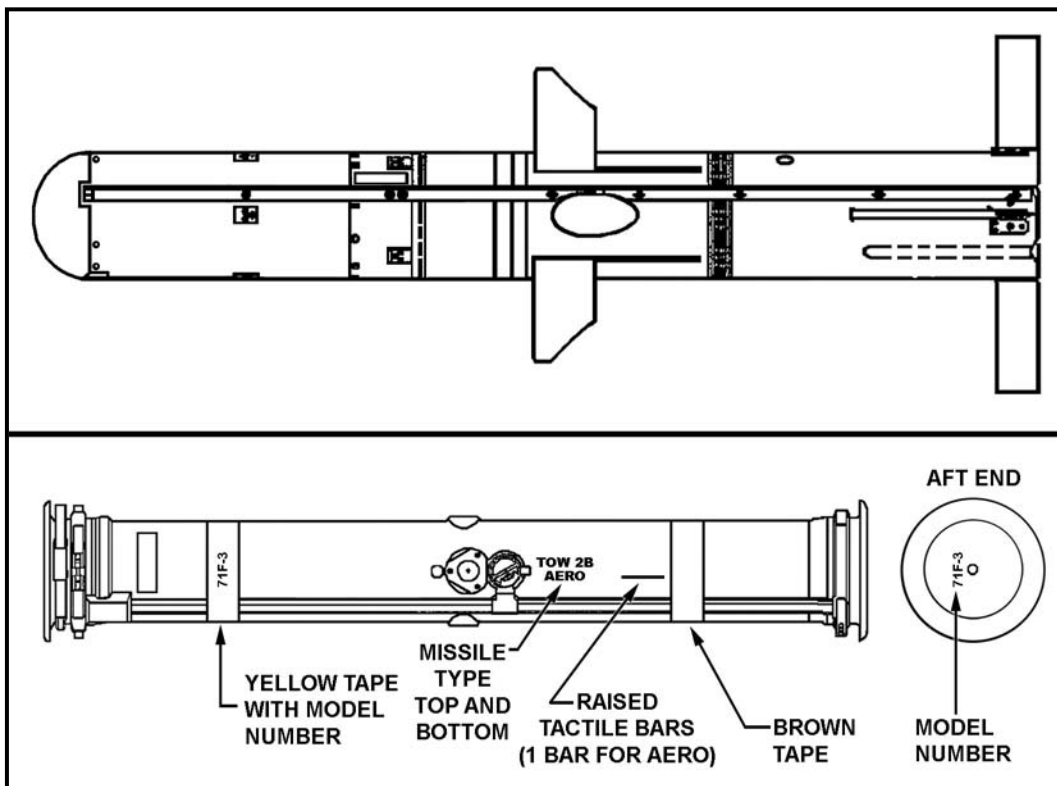
(1) The TOW 2B contains two warheads that detonate downward when the target is identified by both sensors. This causes the two penetrators to enter the target from the top, usually through the turret where the armor is not as strong. The missile case is identified as containing a TOW 2B with the visual missile insignia, which shows the missile flying over the target.

(2) The nose of the TOW 2B missile is also an ogive configuration (crush switch), which allows the warheads to detonate in the direct attack mode. The TOW 2B has a range of 3,750 meters, and it is not available with a practice warhead.



**Figure 1-21. TOW 2B missile and identification.**

f. **TOW 2B AERO (BGM-71F-3)** (Figure 1-22, page 1-26). This version of the TOW 2B missile has an effective range of 4,000 meters, compared to the 3,750-meter range of previous TOW missiles. This longer range allows the TOW crew to engage a target well beyond the range of the weapons of the target vehicle. A crush switch is located behind the aerodynamic nose of the TOW 2B AERO, which enhances the range. A tactile bar is located aft of the umbilical connector, which makes it easier to identify this missile in a low-light environment. (The target detection and warhead description are the same as for the TOW 2B). The TOW 2B AERO is not available with a practice warhead.



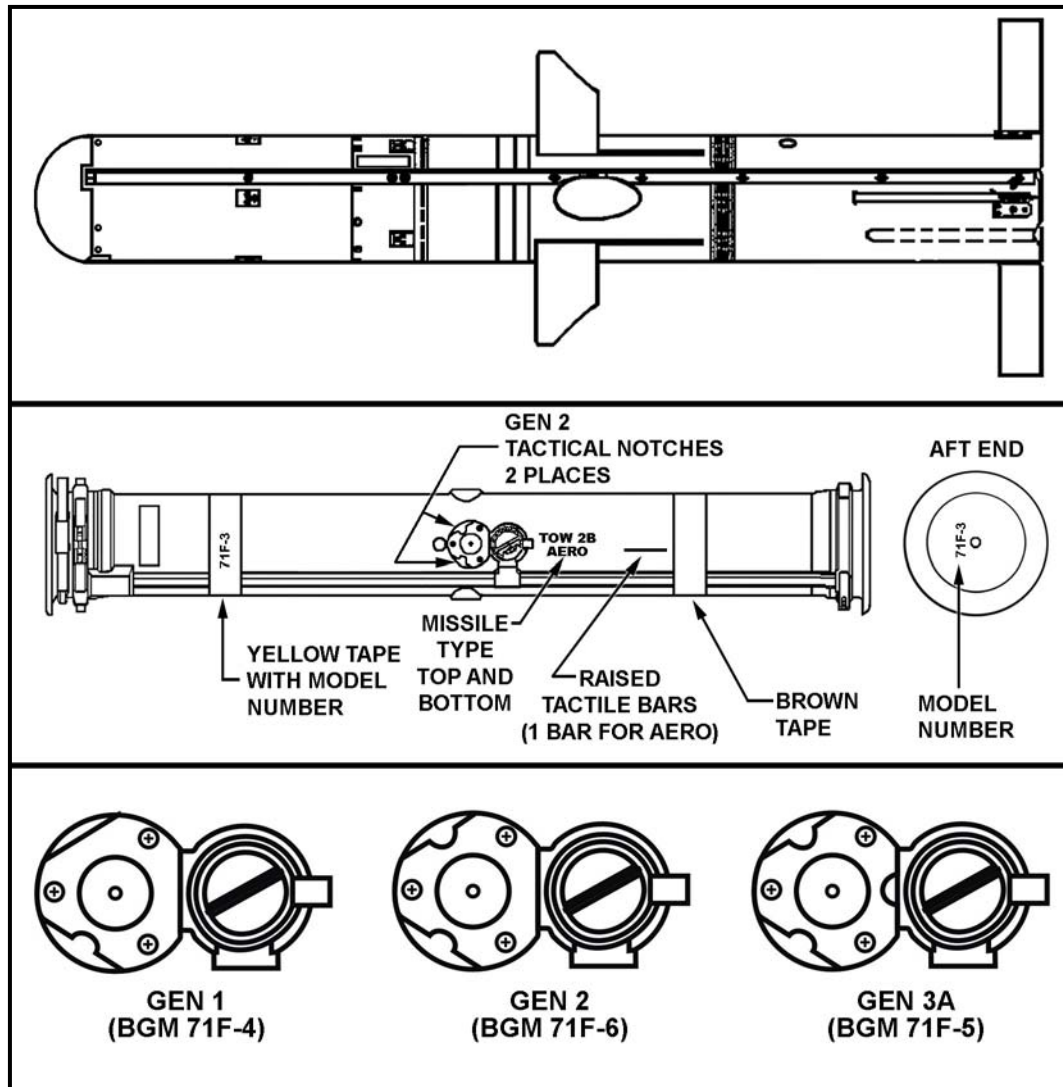
**Figure 1-22. TOW 2B AERO missile and identification.**

g. **TOW 2B AERO with GEN 1 (BGM-71F-4), 2 (BGM-71F-6), and 3A (BGM-71F-5)** (Figure 1-23). This is another version of the TOW 2B missile that has a range of 4,000 meters. It can defeat a target's active protection system, thereby allowing the TOW 2B missile to successfully engage any armored vehicle up to 4,000 meters.

(1) To identify the generation (GEN) of the missile, tactile notches are contained on the plate of the holdback pin. GEN 1 type missile (BGM-71F-4) has a single notch; GEN 2 type missile (BGM-71F-6) has two notches; and GEN 3A type missile (BGM-71F-5) has three notches (one at each of the three flat edges of the plate).

(2) The target detection and warhead description are the same as for the TOW 2B missile. This missile is not available with a practice warhead.





**Figure 1-23. TOW 2B AERO missile with identification and GEN tactile identification.**

h. **TOW BB (BGM-71H)** (Figure 1-24, page 1-28). The TOW BB missile is a bunker-buster—a modification to the TOW 2A missile. It has a range of 3,750 meters and can defeat bunkers, breach masonry walls, and engage all targets in support of military operations in urban terrain (MOUT). The TOW BB should only be fired from under armor (as noted on the missile case).

(1) The nose of the TOW BB is the crush switch, which allows the warhead to detonate upon impact with the target. The warhead is the full 6-inch diameter of the missile body. The TOW BB is not available with a practice warhead.

(2) Two tactile bars are located aft of the umbilical connector on the curvature of the missile case and are used to identify the missile as a bunker-buster.

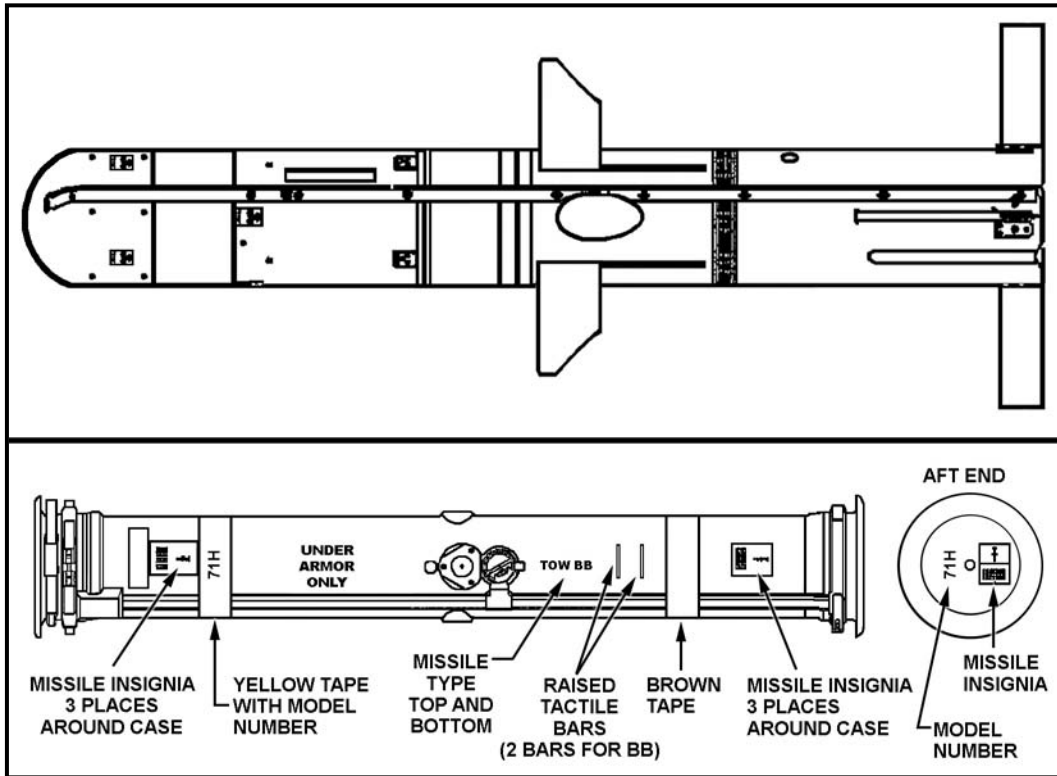


Figure 1-24. TOW BB missile and identification.

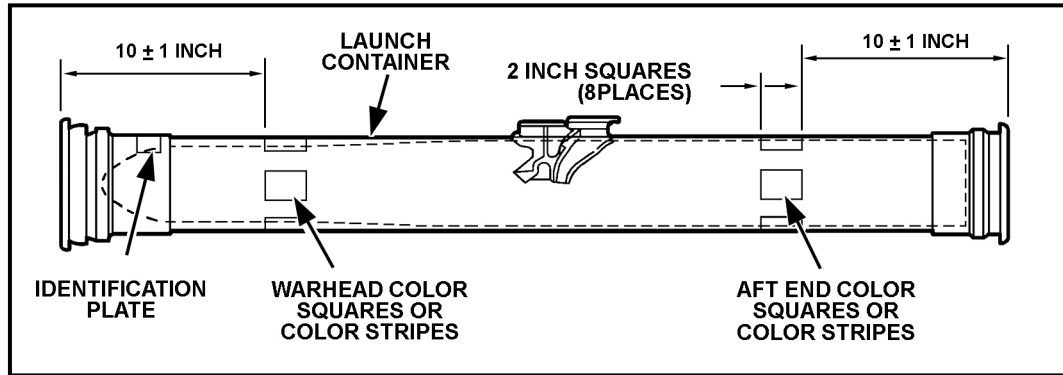
### 1-8. HANDLING AND STORAGE

Use the following procedures for handling and storage of encased TOW missiles.

#### WARNINGS

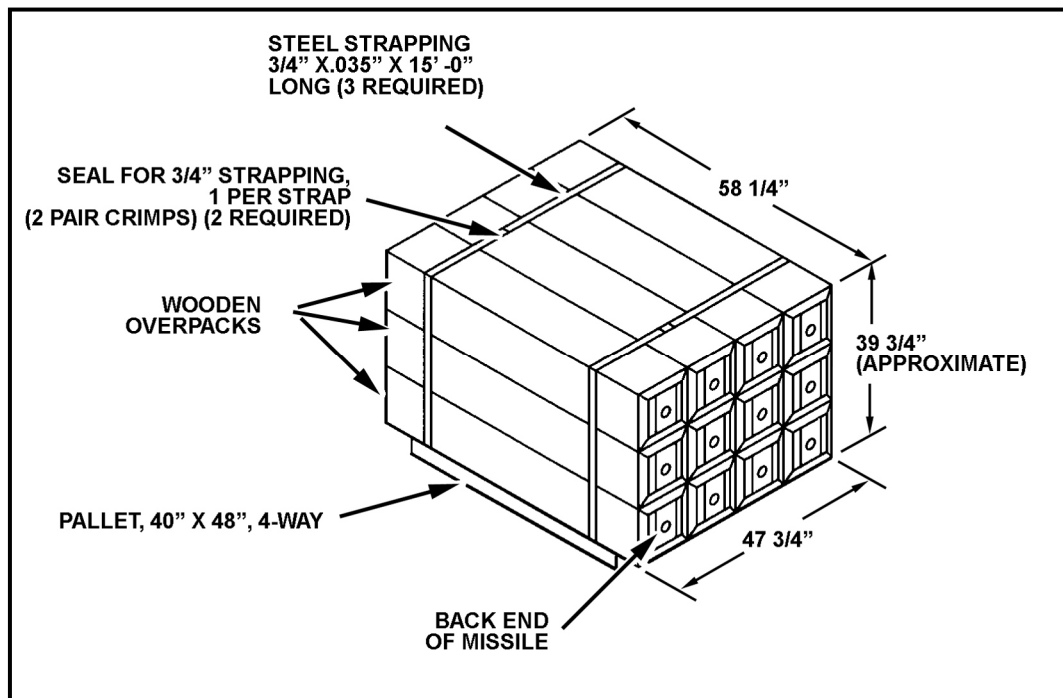
1. Damaged TOW missiles can misfire or hangfire and seriously injure or kill soldiers.
2. Do not load missiles with damaged cases.
3. Do not load missiles with damaged diaphragms.
4. Do not load missiles with a pink humidity indicator on the rear diaphragm.
5. Do not upload TOW missiles that have had the front end cap removed for more than 30 days. Any TOW missile with the front end cap removed for more than 30 days should be returned to the ammunition supply point (ASP) as soon as possible.

a. **Handling.** Do not try to remove the missile from the launch container (Figure 1-25). Do not handle the encased missile roughly or drop it. Damage may occur to the motor propellant grain or other components and cause a failure at launch or in flight.



**Figure 1-25. Launch container with encased missile.**

b. **Storage.** Protect encased missiles from sun, rain, and moisture. Use at least 6 inches of dunnage under the wooden overpacks (Figure 1-26). Put waterproof cover over and around the stack of missiles. The shelter should be big enough to provide good air circulation. The shelter and encased missiles should be accessible, in good condition, and ready for immediate use.



**Figure 1-26. Palletized encased missiles.**

(1) All encased missiles in a storage area must be stored with the nose end pointing in the same direction. Direction and storage should provide the least danger to personnel and equipment in case of explosion or fire.

(2) The storage area should provide the most protection from damage, corrosion, or deterioration. The storage temperature must be between -53.9 and +68.3 degrees Centigrade (-65 to 155 degrees Fahrenheit). The storage area should—

- Be on level ground and have the most protection from the weather.
- Have good drainage.
- Be arranged so that inspection of the missile can be performed as required.
- Meet quantity-distance requirements.

(3) Missiles are encased and stored in wooden overpacks. The encased missiles must be inspected before they are stored. (Storage data is included in Table 1-4.)

Nomenclature	Guided Missile Surface Attack (BGM-71-Series)	Guided Missile, Practice (Inert Warhead, Live Motors) (BTM-71-Series)
National stock number (NSN)	See Table 4-2.	See Table 4-2.
Basic color of encased missile	Olive drab	Olive drab
Color of data markings on encased missile	White or yellow	White
Color code marking on encased missile aft end	Four 2-inch brown squares 90° apart or 2-inch stripe	Four 2-inch brown squares 90° apart or 2-inch stripe
Color code marking on encased missile warhead end	Four 2-inch yellow squares 90° apart or 2-inch stripe	Four 2-inch blue squares 90° apart or 2-inch stripe
Basic color of wooden overpack container	Olive drab or unpainted	Olive drab or unpainted
Color code marking on wooden overpack	Black (not to exceed 4-inch squares) six places diagonally opposite on tope corners, sides, and ends	Blue (not to exceed 4-inch squares) six places diagonally opposite on tope corners, sides, and ends
Color of data marking on wooden overpack	White or black	White or black
Bar code label	Encoded NIIN, PN, SN, and QTY	Encoded NIIN, PN, SN, and QTY
UN marking on wooden overpack	ROCKETS UN: 0181	ROCKET MOTORS UN: 0280
UN POP marking on wooden overpack	4D/Y43/S/YR USA/DOD	4D/Y43/S/YR USA/DOD
DOT hazard classification	Class A EXPLOSIVE	Class A EXPLOSIVE
Quantity-distance classification	1.1	1.1
Storage compatibility group	E	C
Storage temperature limit	-65 to +155°F (-53.9 to + 68.3°C)	-65 to +155°F (-53.9 to + 68.3°C)

**Table 1-4. TOW encased missile color coding, shipment, and storage data.**

c. **Overpack Data.** The TOW encased missile is normally shipped and stored in a wooden overpack to protect it from transportation shocks. (Data for the overpack is included in Table 1-5.) The overpack contains the encased missile and padding around the missile. The launch container is part of the encased missile and provides protection for it. Take care in handling the encased missile (Figure 1-27).

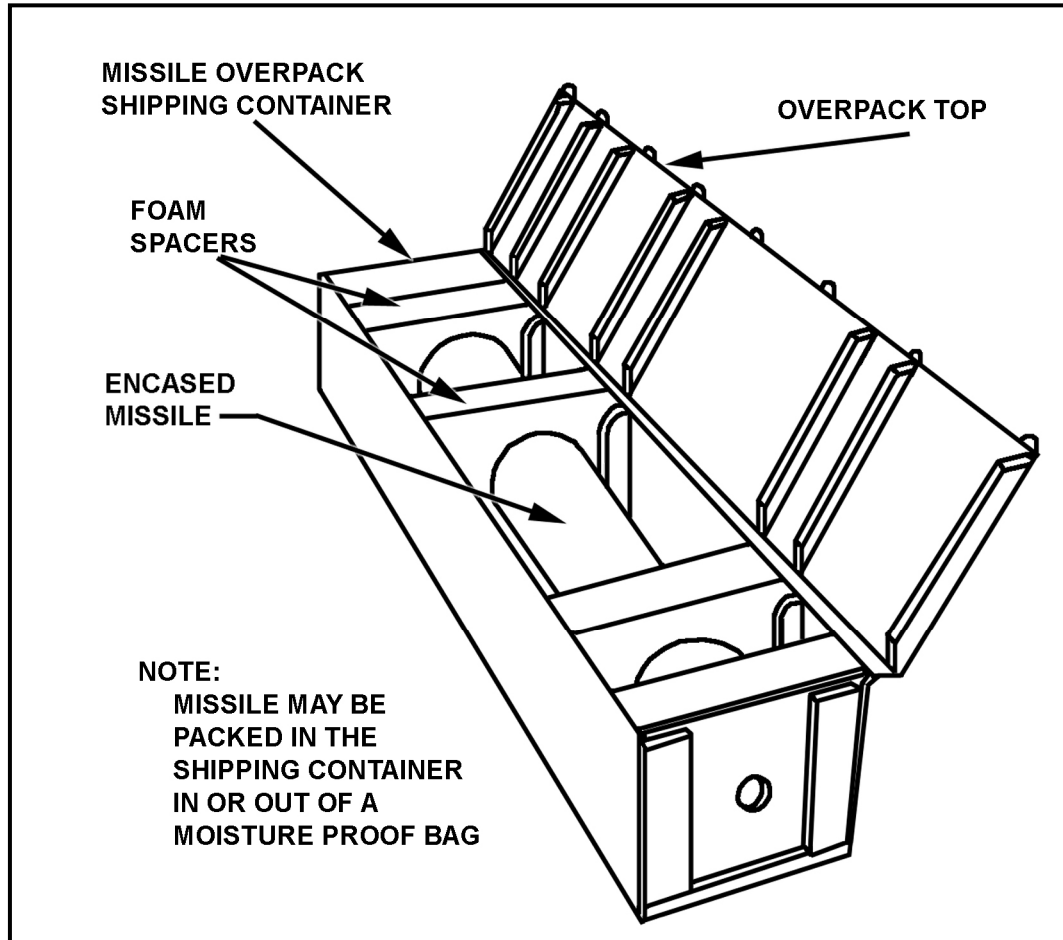


Figure 1-27. Encased missile in wooden overpack shipping container.

Weight (empty)	35.3 pounds
Weight (with missile)	
-71A-Series	89 pounds
-71C-Series	89 pounds
-71D-Series	93 pounds
-71E-Series	97 pounds
-71F-Series	97 pounds
-71H-Series	99 pounds
Stacking height	12.0 inches
Length	57.6 inches
Volume	4.8 cubic feet

Table 1-5. Overpack shipping container data (all values are nominal).

### 1-9. INSPECTION

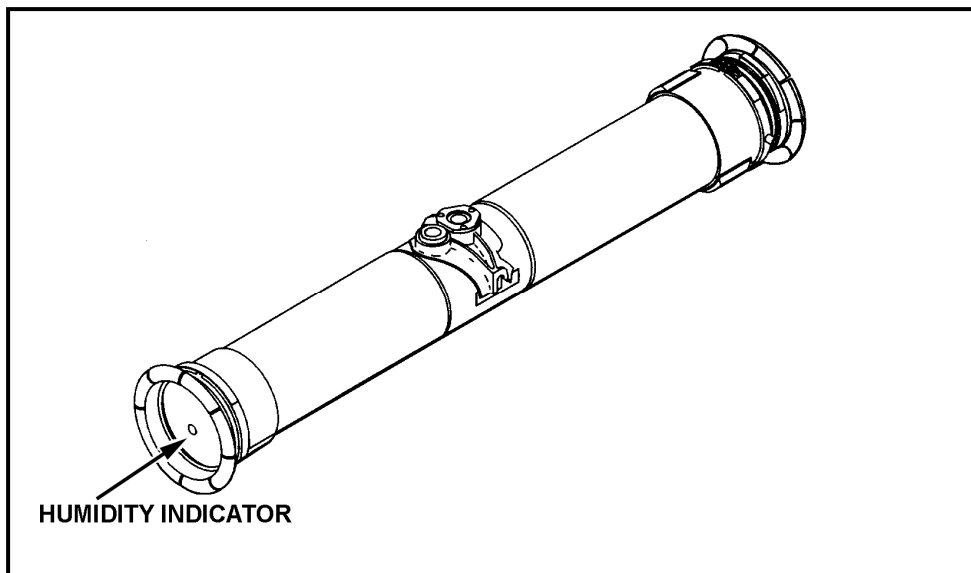
Encased TOW missiles must be inspected upon receipt of shipment. Inspection is also required once a year for stored missiles.

- NOTES:**
1. Notify the supporting organization for scheduling of inspections.
  2. Refer to TM 9-1410-470-34 for instructions on removing encased missiles from the wooden overpack shipping container and replacement of the encased missile into the overpack shipping container after inspection.

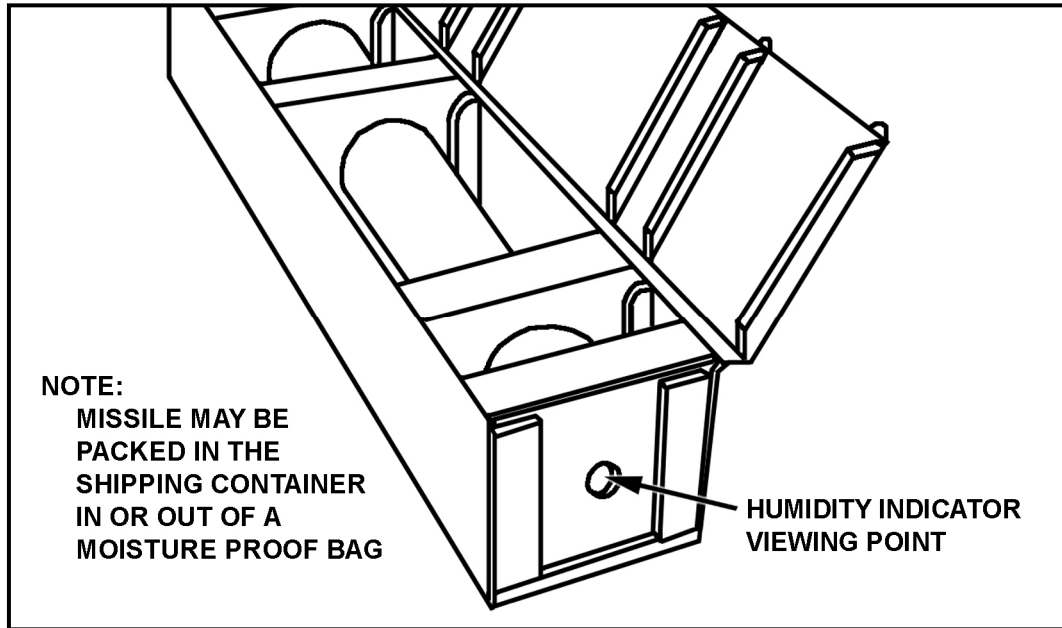
#### **WARNING**

**If the wooden overpack shipping container or launch container is punctured or damaged in such a way that the missile inside may be damaged, the missile should be treated as hazardous material and EOD personnel notified.**

- a. Inspect outside the wooden overpack shipping container to make sure it is not damaged in any way.
- b. If the encased missile is in a plastic bag, open the bag, remove the encased missile, and discard the bag.
- c. The humidity indicator is visible at the aft end of the encased missile (Figure 1-28). If the missile is in the overpack, the humidity indicator will be visible through the window at the rear of the overpack (Figure 1-29). If the humidity indicator is blue, proceed with the inspection. If the humidity indicator is pink, return the encased missile to the appropriate ASP as soon as possible.

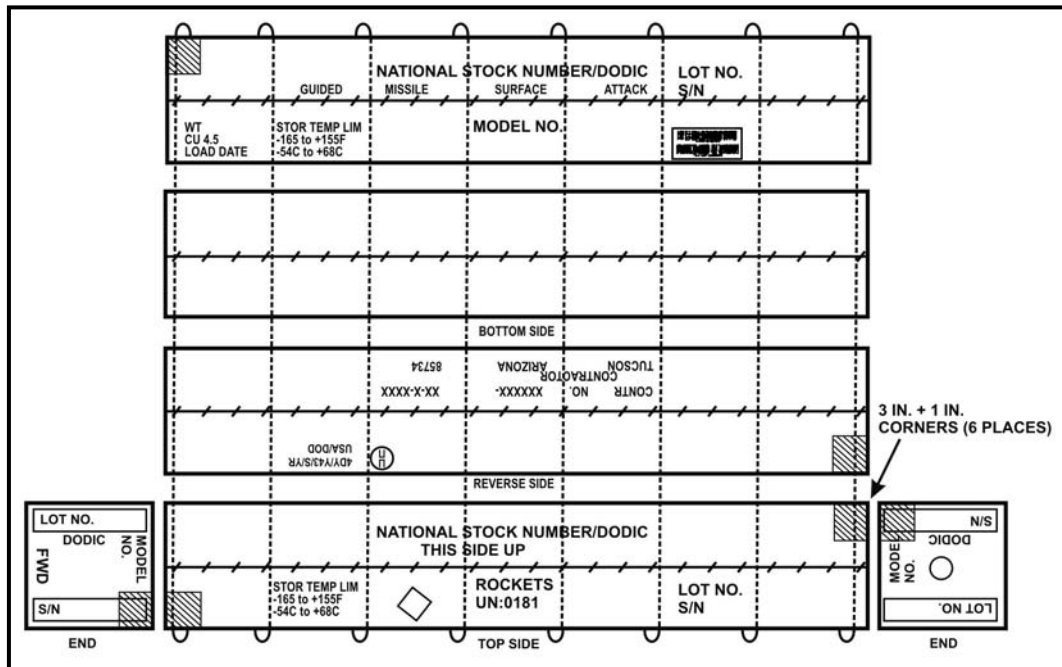


**Figure 1-28. Humidity indicator on encased missile.**



**Figure 1-29. Wooden overpack shipping container.**

d. Check the marking (Figure 1-30) on the wooden overpack shipping container to ensure the ammunition is identified correctly. (See Tables 1-2 [page 1-20], 1-3 [pages 1-21 and 1-22], and 1-4 [page 1-31] for missile identification data.)



**Figure 1-30. Missile wooden overpack markings.**

- e. Check the shipping papers to ensure that the ammunition received matches what is on the shipping documents.
- f. Check the launch container for the proper markings, identification, and color coding (Figure 1-31 and Table 1-4 [page 1-31]).

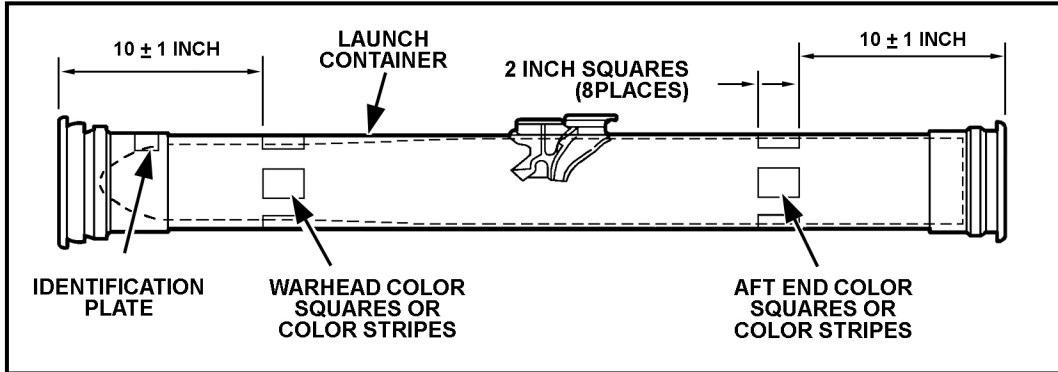


Figure 1-31. Launch container markings.

- g. Check the forward and rear handling rings on the encased missile to make sure they are not damaged.

**1-10. GUNNER NOTES**

Each TOW missile type has one of two modes of attack: direct or fly-over-shoot-down (FOSD).

a. **Direct Attack.** All BGM-71A-, -71C-, -71D-, -71E-, and -71H-series, and all BTM-series (practice missiles), are direct attack missiles. These missile fly on the gunner's line of sight to the target (Figure 1-32). The missile will hit the target where the gunner's crosshairs are positioned (Figure 1-33). The warhead detonates upon impact with the target.

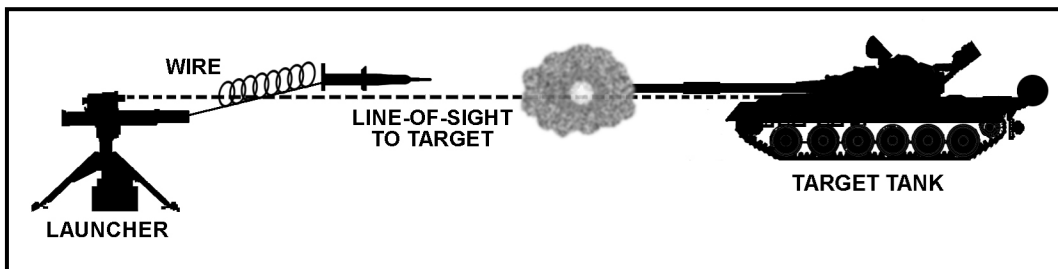
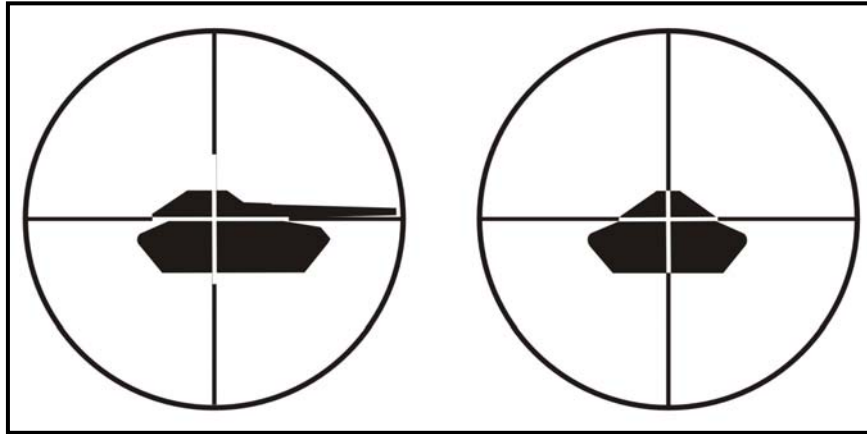


Figure 1-32. Direct attack: missile flies line of sight.

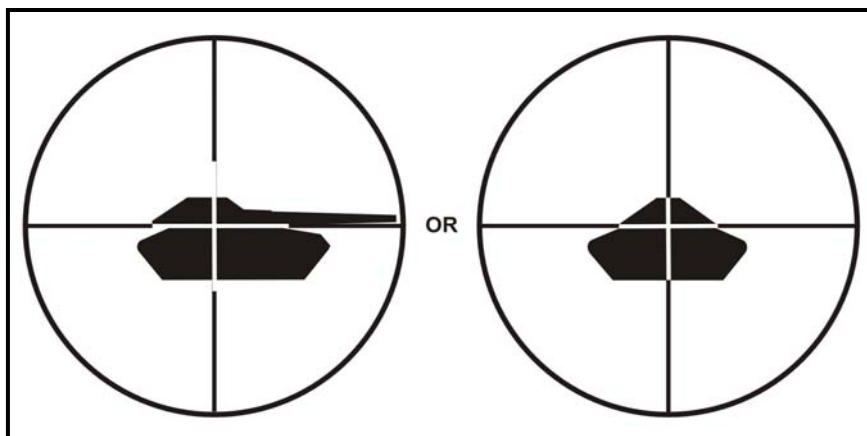




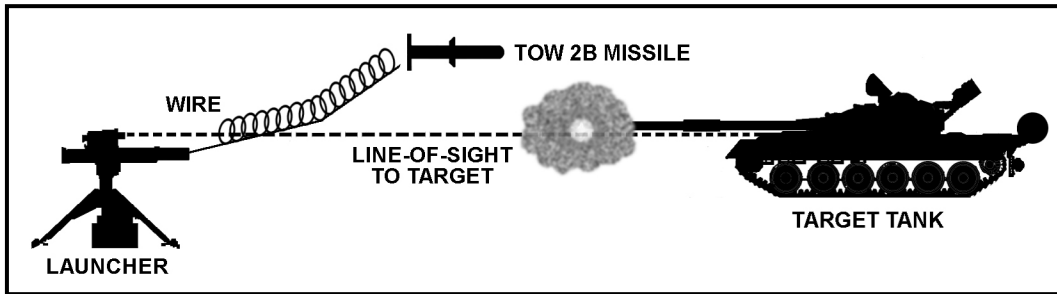
**Figure 1-33. Gunner's aim point.**

b. **Fly-Over-Shoot-Down.** The BGM-71-series of missiles (TOW 2B and TOW 2B AERO) are optimized to use the FOSD type of attack (Figure 1-34). The missile will fly over the target and shoot down when the warhead detonates. These missiles fly above the gunner's line of sight, so they can engage targets that are hidden (for example, behind a berm). Sensors determine when the warhead will detonate. There are two sensors: one is a magnetometer that senses and looks for a large concentration of iron below it; the second sensor ranges down to the ground and identifies when the range changes relative to known target profiles. When these two conditions are met, the warhead detonates, forming two penetrators that shoot down upon the target.

(1) For the TOW 2B and TOW 2B AERO missiles, the gunner must always keep the crosshairs of the TOW weapon system at the center of mass of the target—or where the center of mass would be for a hidden target (Figure 1-34). The software in the launcher determines how high the missile will fly. The launcher will fly the missile about 10 feet above the gunner's line of sight so it flies over the target (Figure 1-35, page 1-36). If the gunner's aim point is too high, the missile will fly too far above the target to kill it.



**Figure 1-34. Gunner's aim point for FOSD TOW missiles.**



**Figure 1-35. FOSD missile flight path.**

(2) The Improved Target Acquisition System (ITAS) and Improved Bradley Acquisition System (IBAS) launchers can fly the TOW 2B on the line of sight, allowing the missile to be used as a direct attack missile. If this mode is selected by the gunner while using the ITAS or IBAS, the gunner must still maintain the crosshairs on the center of mass of the target.

c. **Summary.** The TOW gunner must always keep the crosshairs on the center of mass of the target, no matter which TOW missile is being used.

### 1-11. OPERATION UNDER UNUSUAL CONDITIONS

Knowing how environmental conditions will affect the operation and performance of the TOW missile is important.

a. **Cold Weather.** Check for ice and snow on the encased missiles. Ice and snow should not be allowed to collect on the encased missile. The missiles should remain in the overpack or under cover before loading onto the tactical vehicle.

**NOTE:** The TOW Weapon System will not operate properly below -31.7 degrees Centigrade (-25 degrees Fahrenheit).

b. **Hot Weather.** Avoid exposing the encased missiles to prolonged direct sunlight during hot weather. The TOW missiles should be protected from heat and direct sunlight. Tarpaulins, brush, and anything that provides shade may be used as protection if shelter is not available.

**NOTE:** The TOW Weapon System will not operate properly above +60 degrees Centigrade (+140 degrees Fahrenheit).

c. **High Humidity.** The TOW missile will operate regardless of the humidity. However, moisture must be kept out of the encased missile. Checking the humidity indicator at prescribed intervals ensures no moisture is in the encased missile. Avoid exposing the encased missiles to rain, snow, or hail when not engaged in operations. Avoid getting moisture into the electrical connector.

d. **Air Pressure.** The air is thinner at higher altitudes, which will require more time for the missile to correct for a steering error than for the same steering error at a lower altitude. Since the launcher automatically adjusts for altitude, the gunner only has to tack

the target through the sighting system. The TOW missile will operate properly up to an altitude of 10,000 feet (3,048 meters).

e. **High Winds.** Firing a missile into a high crosswind can cause slight guidance problems. The TOW Weapon System will automatically adjust for the effects of crosswinds on the TOW missile. If possible, targets should be selected that are up- or downwind of the launcher. The TOW missile should not be fired in winds that exceed 45 miles per hour, if at all possible.

f. **Over Water.** The range of the TOW missile is limited when firing over water or if the guide wires are close to or in the water. The more wire that lays in the water, the shorter the range of the missile will be. If firing over water is required, firing the missile from an elevated position is best—the height of the launcher will keep more of the wire out of the water as the missile flies to the target. The higher the firing position, the greater the range will be. TOW 2 missiles may be fired over 800 meters of water with a range to target of 3,350 meters. If 1,100 meters of wire is in the water, the range will be limited to 1,300 meters.

g. **Smoke and Fire Areas.** Smoke does not limit the range or accuracy of the TOW missiles. A fire, on the other hand, can burn through the command wire causing loss of control of the missile. Avoid firing through or over fires if there is a chance of the command wire being damaged before missile impact.

h. **Side Slope.** Do not fire the TOW missile if the side slope of the launcher is greater than 10 degrees—missile guidance will not be as accurate.

### WARNING

**Do not fire the TOW missile so that the command wires come in contact with electrical wires. If the command wires touch an electrical power line, injury to personnel or damage to the launcher may occur.**

## 1-12. DESTRUCTION

Refer to TM 9-1410-470-34 for demolition of TOW missiles under controlled conditions, and to TM 750-244-4-2 for demolition to prevent enemy use. After a TOW missile reaches the specified shelf life, return the missile to the ammunition control point for disposition.

## 1-13. DUTIES AND RESPONSIBILITIES

The three-man crew consists of the squad leader, the gunner, and the driver-loader. The duties and responsibilities of each crewmember are discussed herein.

a. **Squad Leader.** The squad leader is responsible for the combat readiness and tactical employment of his squad, which includes discipline, health and welfare, training, and maintenance of equipment and weapons. Other specific duties include:

- Directing the driver over the exact route.
- Detecting and identifying targets.
- Issuing fire commands.

- Controlling fire and movement.
  - Supervising and assisting in dismounting and assembly of the M41 ITAS.
  - Employing the squad according to the orders of the section leader.
  - Selecting primary, alternate, and supplementary firing positions.
  - Requesting squad resupply.
  - Informing the section leader of events that affect the tactical situation and of the status of his crew.
  - Carrying the tripod, launch tube, and binoculars when the ITAS is used in the ground mode.
  - Acting as the gunner, when needed.
  - Assisting the gunner in system check-out procedures.
  - Supervising construction of the ITAS firing position.
  - Determining the direction of fire.
- b. **Gunner.** Specific duties of the gunner include:
- Conducting system check-out procedures.
  - Acquiring, recognizing, and identifying targets.
  - Determining if a target can be engaged.
  - Engaging targets.
  - Recognizing and eliminating firing-angle limitations.
  - Adjusting the gunner's platform before stowing the FCS.
  - Mounting the FCS, TAS, and traversing unit.
  - Preparing range cards for the ITAS.
  - Removing the TAS, launch tube, traversing unit, and FCS when the ITAS is used in the ground mode.
  - Carrying the FCS and TAS to the firing position when the ITAS is used in the ground mode.
- c. **Driver-Loader.** The driver-loader is a dual-purpose position in the M1121 ITAS squad. Specific duties of the driver-loader include:
- Driving the M1121.
  - Maintaining the vehicle.
  - Camouflaging the vehicle.
  - Carrying the traversing unit, encased missile, and BPS to the firing position when the ITAS is used in the ground mode.
  - Securing the area.
  - Stowing BPS, encased missiles, and tripod on the M1121 with the assistance of the squad leader.
  - Maintaining radio equipment.
  - Removing misfired missiles.
  - Loading encased missile.

## Chapter 2

# CONTROLS AND INDICATORS

*The ITAS controls and indicators allow the gunner to perform and monitor all operations of the system. This chapter is an overview of these controls and indicators.*

### 2-1. TRIPOD INDICATORS

Tripod indicators include the level indicators and the detent stop markings.

a. **Level Indicators.** The two level indicators on the tripod indicate when the tripod is level. They are helpful when trying to set up the system on uneven terrain. (Figure 2-1).

b. **Detent Stop Markings.** These markings on each leg denote three adjustable height positions for assembly. The detent automatically locks into each position, beginning with the lowest, as the operator lifts up on the tripod body to adjust the height (Figure 2-1).

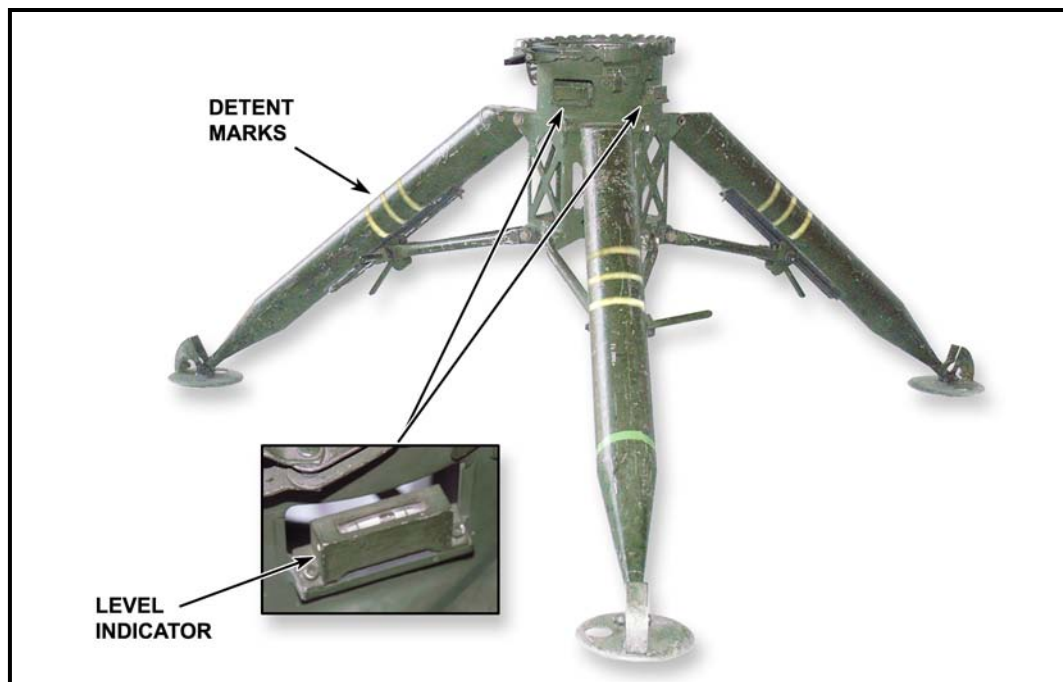


Figure 2-1. Tripod indicators.

## 2-2. TRAVERSING UNIT CONTROLS

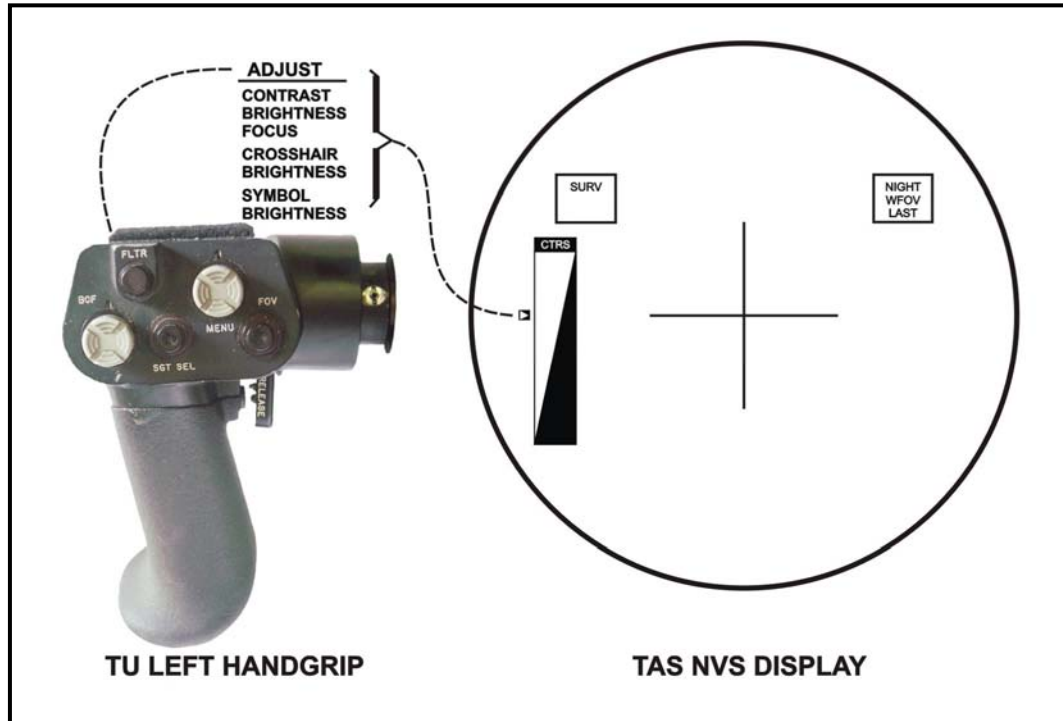
The TU has a left and a right handgrip, which together house the control switches for gunner operation of the ITAS (Figure 2-2).



**Figure 2-2. Left and right handgrips.**

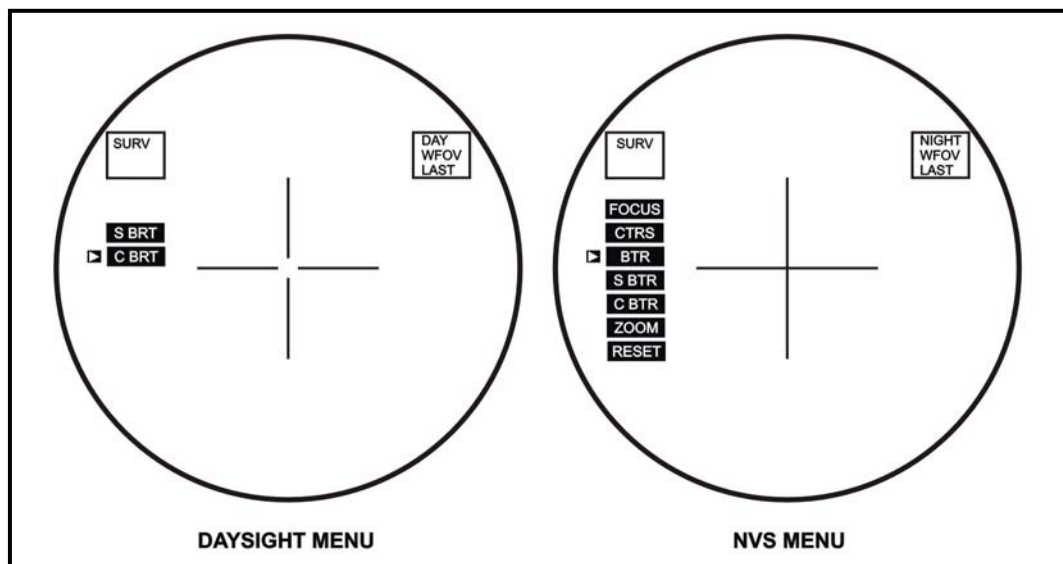
a. **Left Handgrip Controls.** The top of the left handgrip has five control switches, which allow the gunner to conduct surveillance, activate the filter system, and adjust the NVS brightness, contrast, and focus.

(1) **Brightness, Contrast, and Focus (BCF) Switch** (Figure 2-3). The BCF switch is a push-button toggle used to adjust the symbol brightness and the crosshair brightness when using the daysight. When using the NVS, the BCF is used to adjust the TAS display brightness, contrast, and focus. Symbol brightness, crosshair brightness, zoom, and adjustment reset can be selected.



**Figure 2-3. BCF switch and TAS display.**

(a) Pressing the BCF switch one time will bring up the BCF menu (Figure 2-4). Toggling the BCF switch up or down moves the selection cursor up or down in the menu. This menu will terminate after five seconds if no input is received.



**Figure 2-4. BCF menu.**

(b) When the desired adjustment is indicated, pushing the switch again will select the adjustment. After selecting the function for adjustment, toggling the BCF switch up increases the adjustment and toggling the switch down decreases the adjustment. The BCF adjustment indicator is shown on the left side of the display with a small cursor moving up or down along the side of the scale. Figures 2-5 through 2-8 show the effect of different types of adjustments.

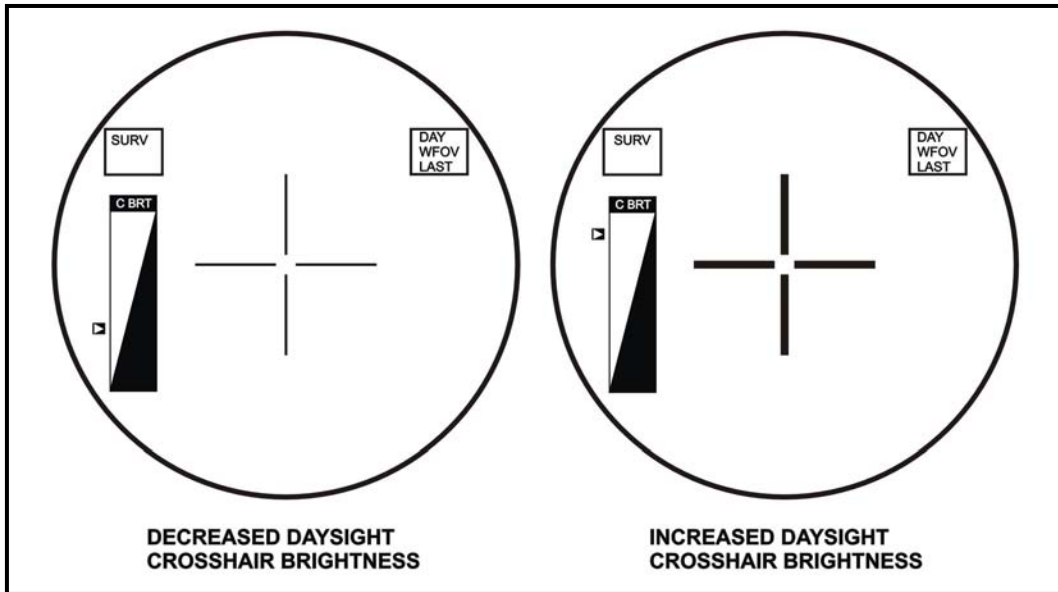


Figure 2-5. Crosshair brightness indicator.

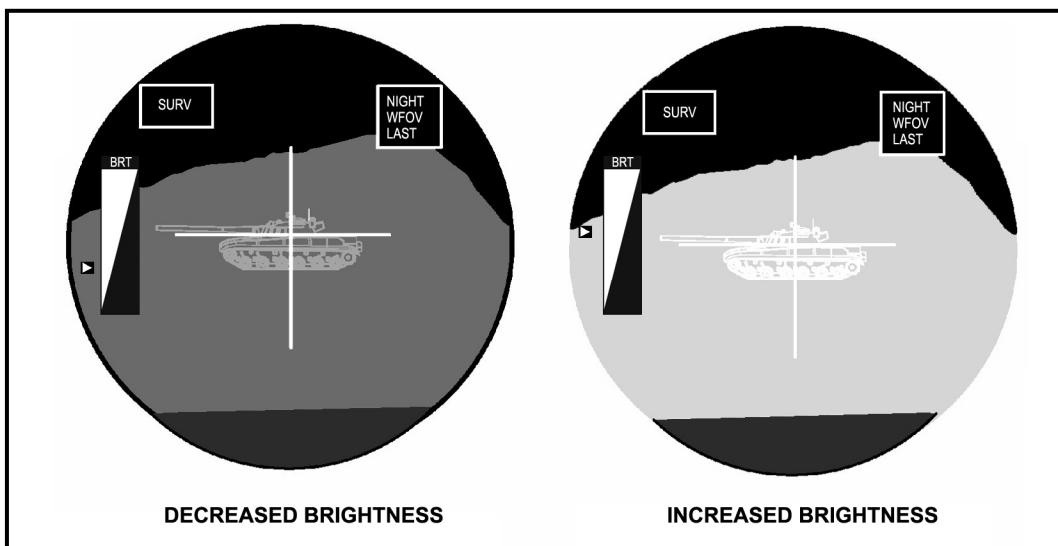


Figure 2-6. NVS brightness indicator.



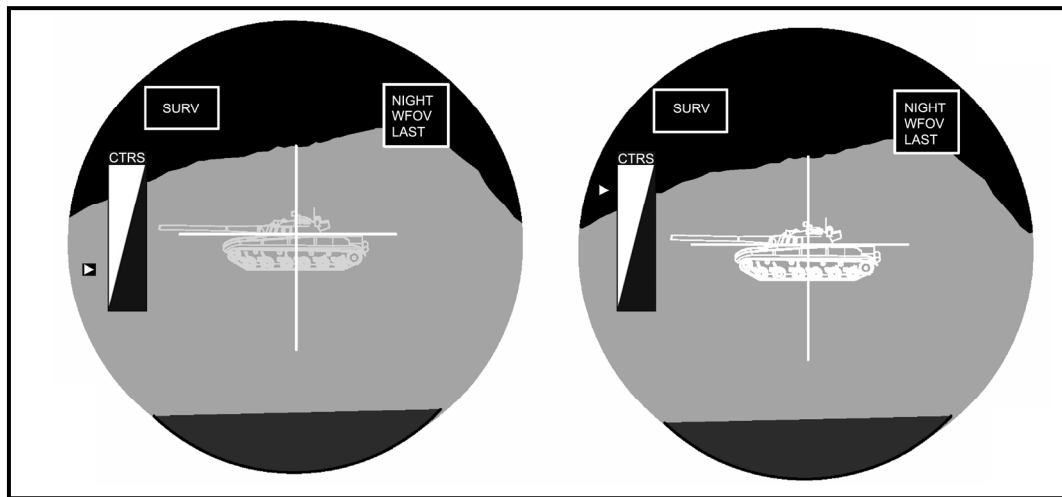


Figure 2-7. Contrast indicator.

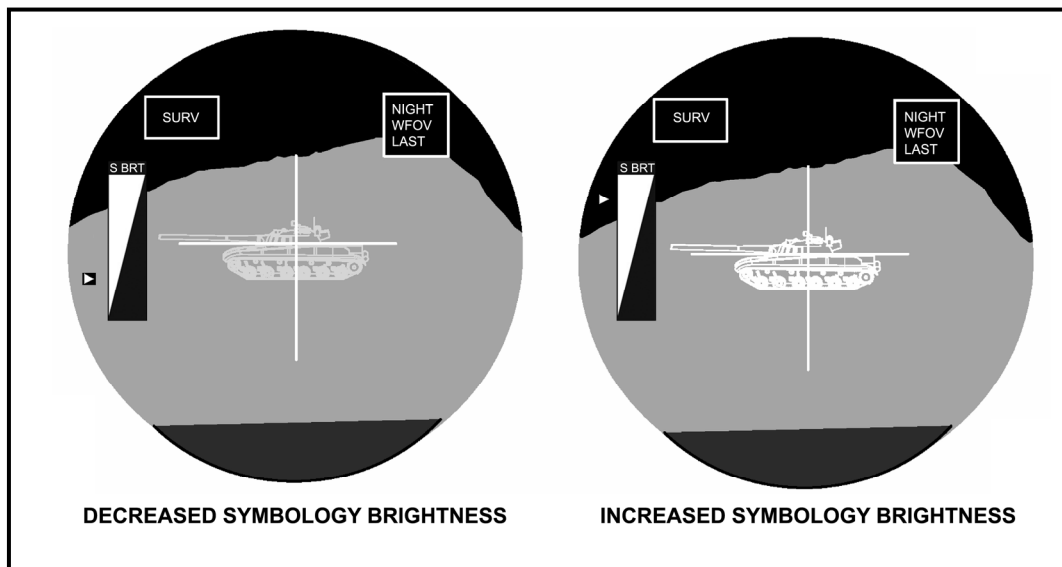
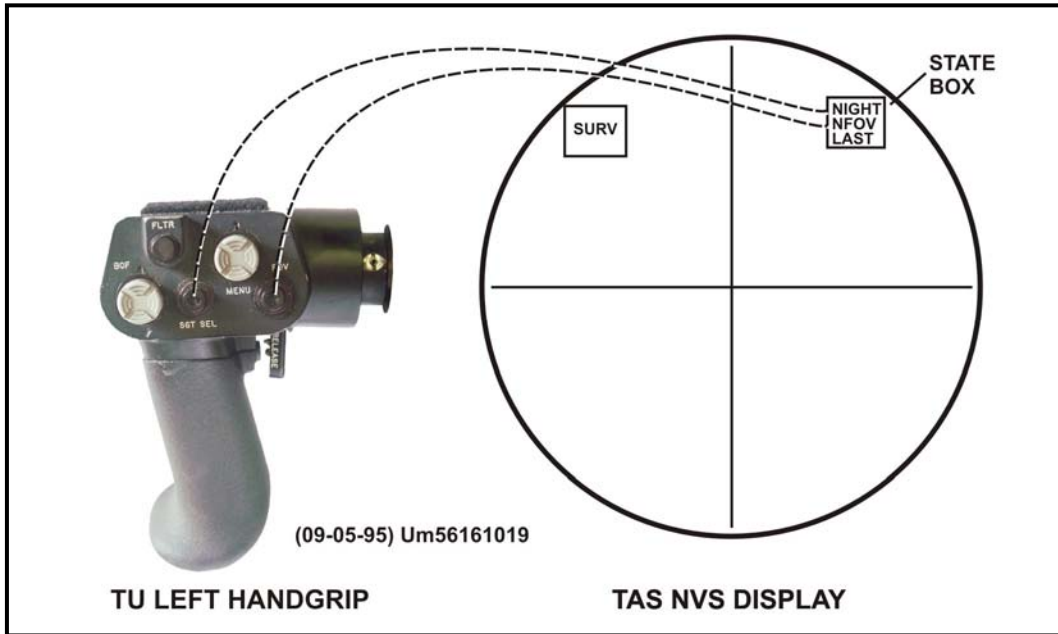


Figure 2-8. Symbol brightness indicator.

(2) *Sight Select (SGT SEL) Switch.* The SGT SEL switch is a push-button switch that is only operable after the NVS has cooled down. The gunner uses this switch to select between daysight and NVS. The STATE BOX in the TAS display will indicate which sight the gunner has selected (Figure 2-9, page 2-6).

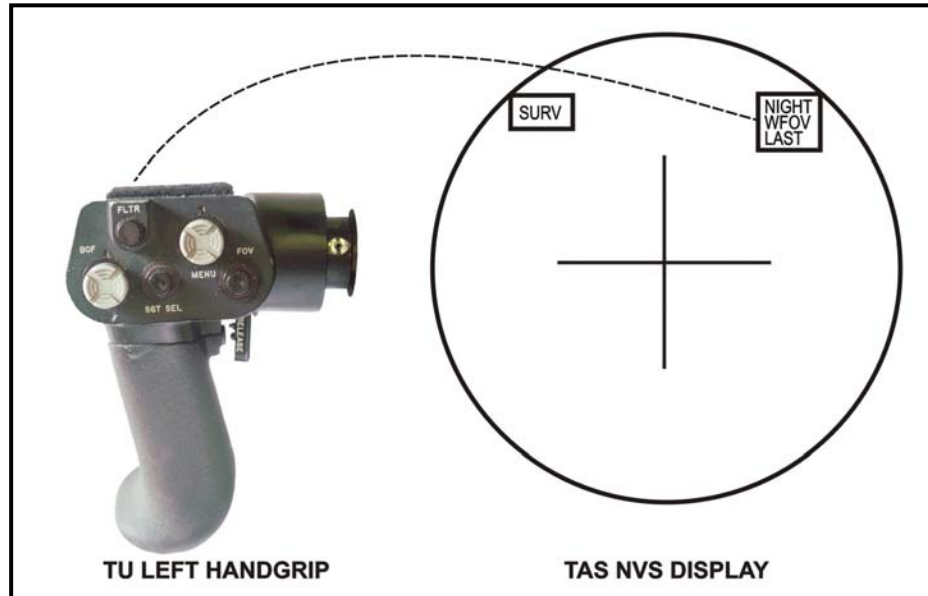


**Figure 2-9. SGT SEL, FOV switch, and TAS display.**

(3) **Field of View (FOV) Switch.** The FOV switch is a push button that allows the gunner to choose between WFOV and NFOV for either sight (daysight or NVS). The STATE BOX in the TAS display will indicate which field of view has been selected (Figure 2-9).

(4) **ITAS Filtering System.** The ITAS has a built-in filtering system as a counter-countermeasure.

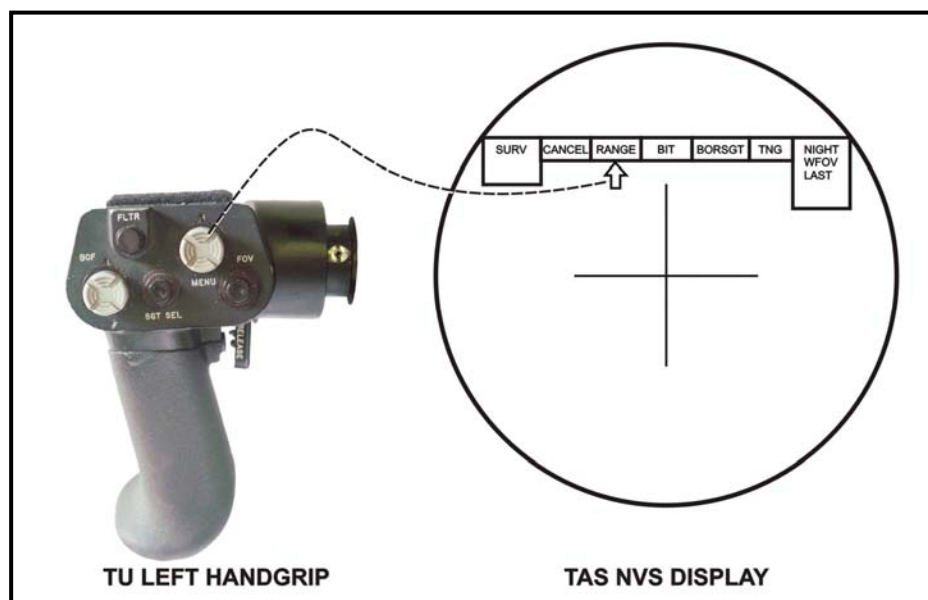
(a) **Filter (FLTR) Switch.** The FLTR switch is a push button used to activate an optical countermeasure by physically placing a filter into the optical path during NVS use. When the filter is inserted, the gunner will see a slight darkening of the display, and the word FLTR will show in the state box. This filter is not available when using the daysight (Figure 2-10).



**Figure 2-10. FLTR switch and TAS display.**

(b) **Daysight Filters.** A slight green tint on the daysight provides limited protection for the gunner at all times. Also, two clip-on filters are stored in the TAS stow bag.

(5) **MENU Button.** The MENU button is a three-position push button. Pressing down on the center of switch calls up the main menu on the TAS display. Pressing down on the left or right side of the switch moves the cursor to the functions available. Pressing down on the center of menu switch while the cursor is on a function selects that function (Figure 2-11).



**Figure 2-11. MENU switch and TAS display.**

(6) **Release Lever.** A release lever is located on the inside of the left handgrip. It is used to rotate the gunner handgrips from the operating position to the stow position (or vice versa). In the operating position, the gunner can adjust either handgrip for comfort and ease of use (Figure 2-12).

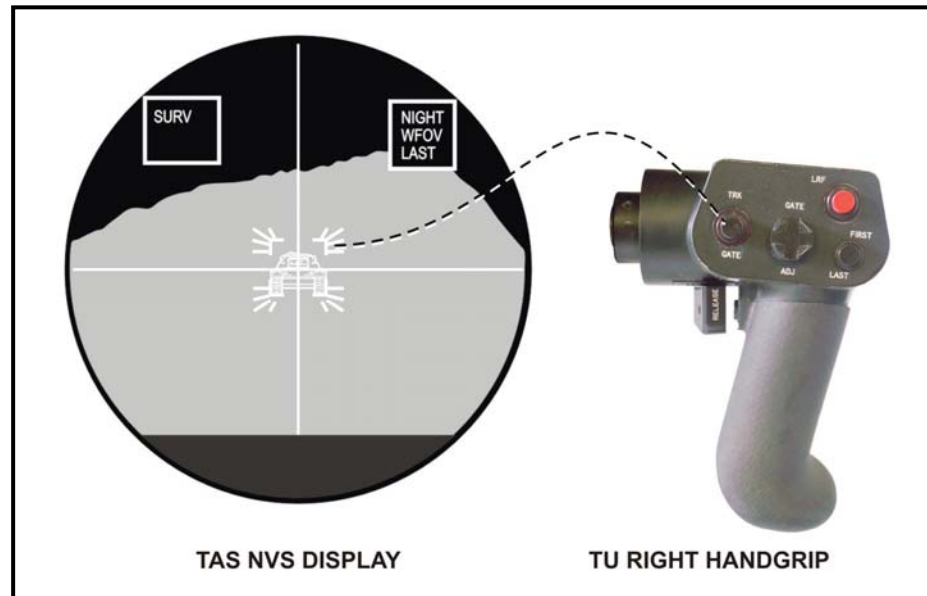
**NOTE:** Using both the left and right release levers at the same time engages the TU elevation brake, allowing the gunner to adjust the handgrips without moving the TU and launch tube elevation angle.



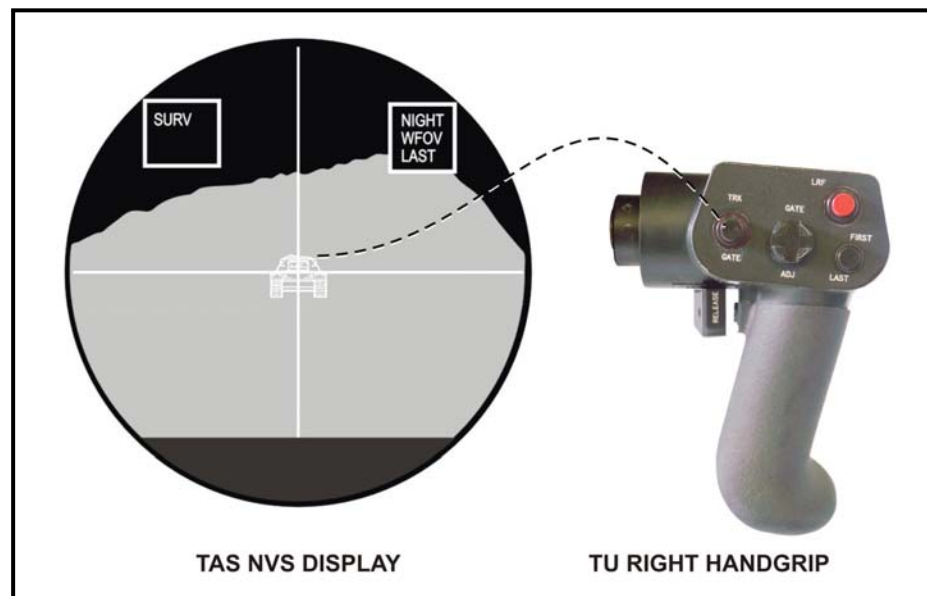
**Figure 2-12. Release lever (left handgrip).**

b. **Right Handgrip Controls.** The top of the right handgrip has four controls, and the fire trigger is located on the backside of the handgrip. The switches on the right handgrip allow the gunner to activate, adjust, and lock the track gates on a target; determine range; verify range; and fire the missile.

(1) **Track Gate (TRK GATE) Switch.** The TRK GATE switch is a three-function button that, when first pressed, activates the track gates (flashing) around a target centered in the crosshairs (Figure 2-13). After adjusting the track gates around the target with the gate adjustment (GATE ADJ) switch, the TRK GATE switch is pressed a second time to lock the track gates on the target (Figure 2-14). If the TRK GATE switch is pressed after lock-on and the crosshairs are within the track gates, the track gates will be removed.

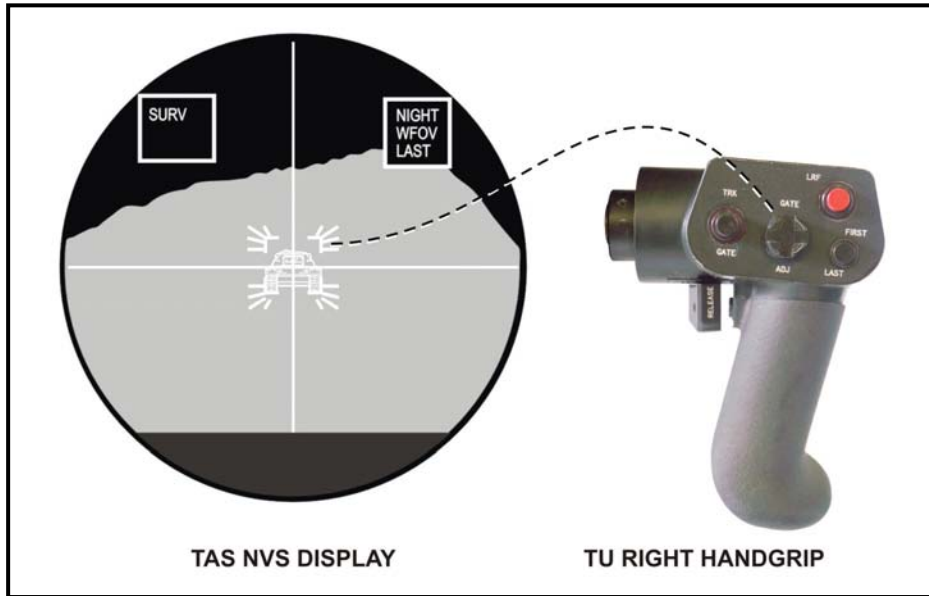


**Figure 2-13. TRK GATE switch and TAS display (flashing track gates).**



**Figure 2-14. TRK GATE switch and TAS indicator (solid track gates).**

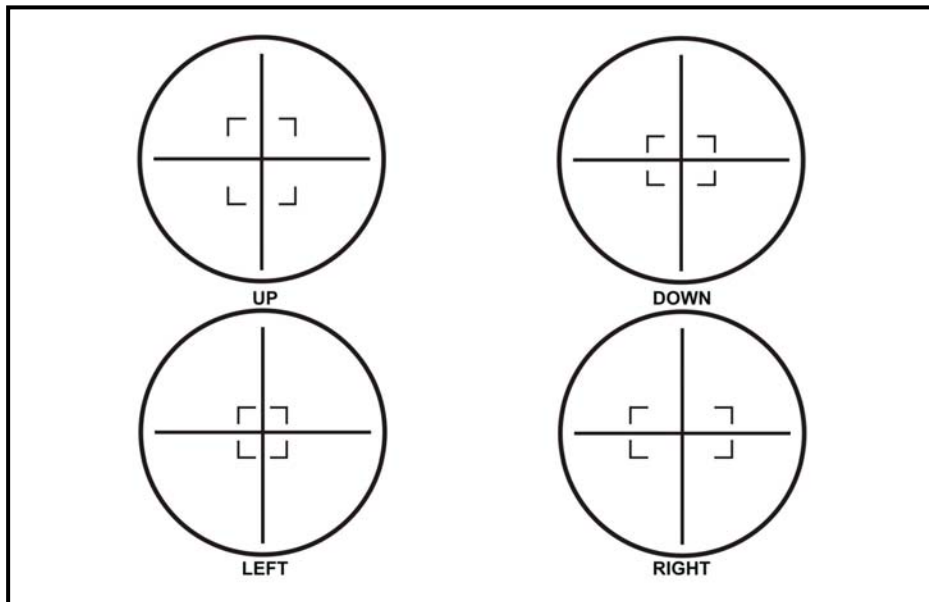
(2) *Gate Adjust Switch (GATE ADJ)*. The GATE ADJ switch is a self-centering, four-position switch (up and down, left and right) used to adjust the size of the track gates around the target during a tracker engagement, and to adjust the passive range box (Figure 2-15, page 2-10).



**Figure 2-15. GATE ADJ switch and TAS display.**

(a) *Up and Down.* **Up** moves the track gates apart vertically and **down** moves the track gates together vertically (Figure 2-16).

(b) *Left and Right.* **Left** moves the track gates in horizontally and **right** moves the track gates out horizontally (Figure 2-16).

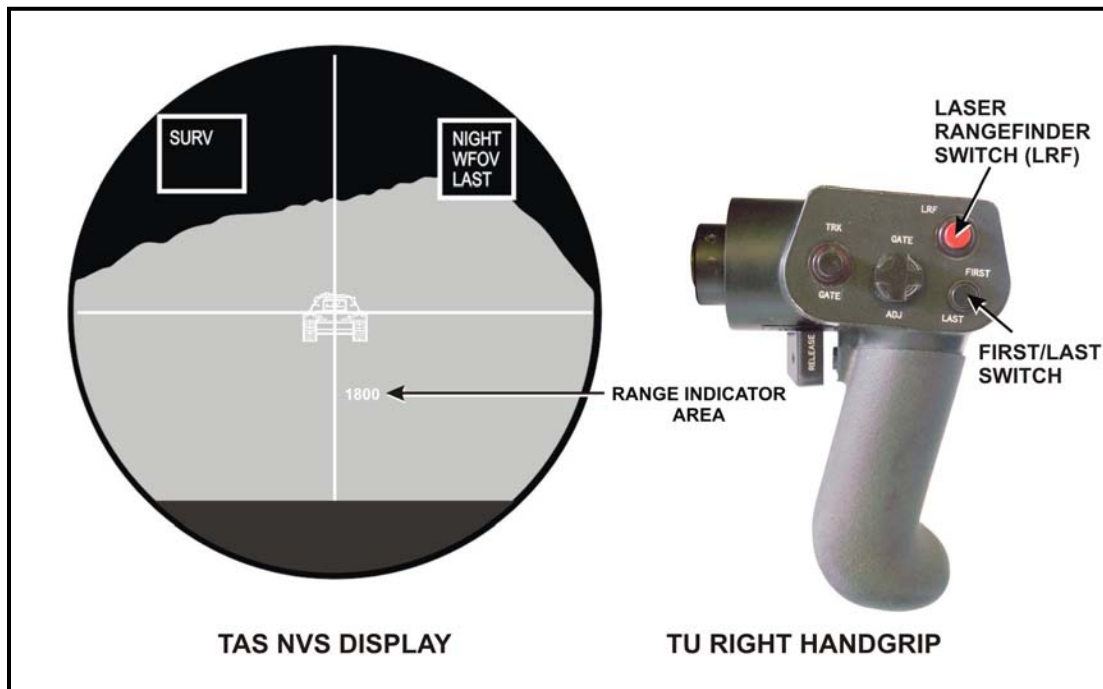


**Figure 2-16. Track gate adjustments.**

(3) *Laser Range Finder (LRF) Switch.* The LRF switch is a push button that, when pushed, provides the range (in meters) to the target. The gunner must have the crosshairs

on the target to get this range. The range return from the target is shown in the range indicator area (Figure 2-17).

(4) **FIRST/LAST Switch.** The FIRST/LAST switch is a push-button switch that provides range verification in conjunction with use of the LRF (Figure 2-17). Selection of FIRST displays range from the nearest object in the LRF beam path. Selection of LAST (default setting) displays range from the most distant object in the LRF beam path. The FIRST/LAST switch will operate in either daysight or NVS.



**Figure 2-17. LRF switch and TAS display.**

(5) **Release Lever.** A release lever is located on the inside of the right handgrip. The release lever is used to rotate the gunner handgrips from either the operating position to the stow position (or vice versa). In the operating position, the operator can adjust either gunner handgrip for comfort and ease of use (Figure 2-18, page 2-12).

**NOTE:** Using both the left and right release levers at the same time engages the TU elevation brake, allowing the gunner to adjust the handgrips without moving the TU and launch tube elevation angle.

(6) **Fire Trigger.** The fire trigger is located under the trigger guard on the backside of the right handgrip at the index finger position. The fire trigger is pulled to begin the missile launch sequence (Figure 2-18, page 2-12).



**Figure 2-18. Release lever (right handgrip) and fire trigger.**

### 2-3. TARGET ACQUISITION SYSTEM CONTROLS

The TAS controls allow the gunner to govern all ITAS operations. All the controls and indicators are located on the TAS and the TU left and right handgrips with the exception of the POWER switch located on the FCS and the POWER switch on the BPS.

a. **Eye-piece Assembly.** The eyepiece assembly consists of diopter adjustment rings, the friction lock, and the eyepiece cover (Figure 2-19).

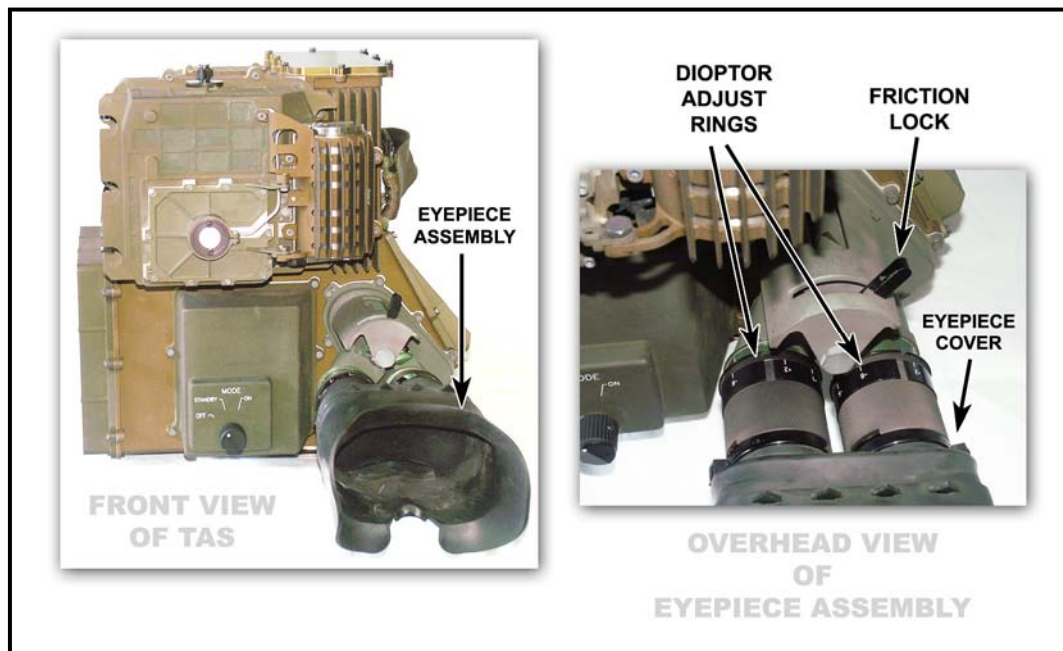
(1) **Diopter Adjust Rings.** A diopter ring is located on each of the TAS eyepieces. It is a hand-rotated ring the gunner uses to adjust the focus of the TAS crosshairs and symbols. The adjustment compensates for individual differences in vision. The rings are calibrated in steps, known as diopters, with an adjustment range from +2 to -6, which means that any gunner with vision correctable to 20/20 can use the TAS and see an



in-focus image without using glasses. Once the gunner adjusts the diopter adjust ring, there is no need to readjust it until a different gunner uses the TAS.

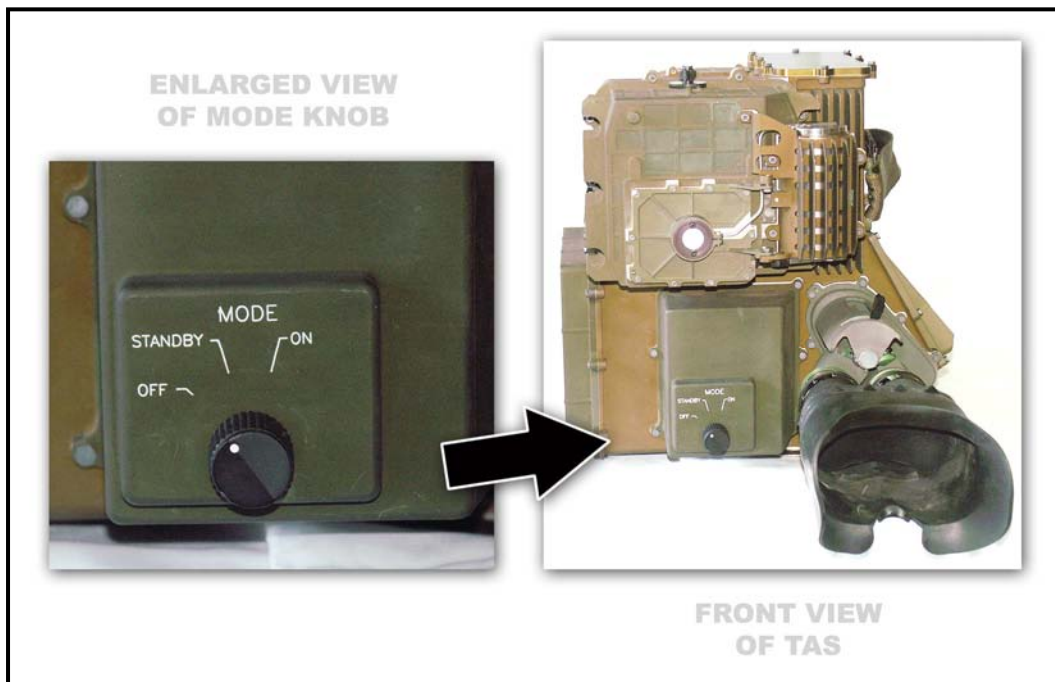
(2) **Friction Lock.** The friction lock is located on top of the eyepiece assembly. It is a metal lever that the gunner uses to lock the eyepieces after adjusting for eye separation. Move the lever to the left to loosen the lock, which allows the eyepieces to be moved closer together or farther apart to fit the gunner's eyes. Move the lever to the right to tighten the lock after adjusting.

(3) **Eyepiece Cover.** The eyepiece cover surrounds the lens on each of the TAS eyepieces. It is a one-piece rubber assembly that blocks out unwanted light when viewing through the TAS. Inside the eyepiece cover is a flap that covers the eyepiece when it is not being used to prevent light from escaping during hours of darkness. Push in on the eyepiece cover to view through the TAS, and pullout on the eyepiece cover when the TAS is not in use.



**Figure 2-19. Eyepiece assembly.**

b. **Power Switch.** The TAS power switch contains a three-position rotary MODE knob that controls the TAS mode of operation by its position (OFF, STANDBY, and ON) (Figure 2-20, page 2-14). Each position brings different components of the TAS into operation.



**Figure 2-20. TAS power switch with MODE knob.**

(1) **OFF Position.** When the power switch is in the OFF position, no power is applied to the TAS. Area surveillance can be made using the last day FOV the TAS was in, wide or narrow, when it was turned off. The missile cannot be launched.

(2) **STANDBY Position.** When the power switch is in the STANDBY position, the ITAS is in the STANDBY mode. This mode is used to conserve power while keeping the NVS cooled down.

(a) In this mode the gunner can also conduct surveillance using the daysight only. The NVS is not available and the missile cannot be launched.

(b) If the system is being operated using the BPS and power needs to be conserved, the gunner can move the power switch back to the STANDBY position so the detectors will stay cool and allow immediate operation when needed. If vehicle power is being used, most gunners will leave the switch in the ON position.

(3) **ON Position.** When the power switch is placed in the ON position, a PBIT is automatically activated. After completion of PBIT, daysight capability is immediately available to the operator (A, Figure 2-21).

(a) **Daysight.** The gunner may switch between daysight WFOV and NFOV using the FOV switch. The gunner can range and engage targets; however, ATT capabilities are not available.

(b) **NVS.** The gunner can engage targets with the NVS after cool down (approximately 10 minutes) and the NVS NOT COOL indicator has gone off (C, Figure 2-21). After the NVS cools, the operator can select NVS operations by pressing the SGT SEL switch or remain in daysight until NVS capabilities are required (B, Figure 2-21).

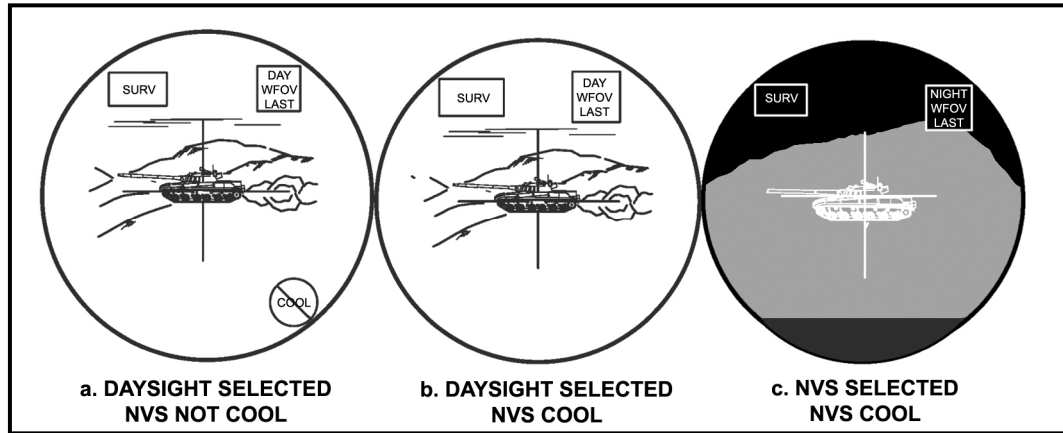


Figure 2-21. Power switch—ON position.

**2-4. TARGET ACQUISITION SYSTEM INDICATORS**

The TAS indicators update the gunner on any changes occurring during system operations. The indicators offer a variety of information to the gunner about the system. For instance, if the gunner presses one of the handgrip control switches, he should see an indicator light on the TAS display that corresponds to the switch he presses or operates. Other indicators will light on the TAS display warning the gunner of malfunctions or certain maintenance actions he should perform. All of the ITAS indicators are shown in Figure 2-22. The gunner, depending on the operational state of the ITAS, may see one or more of the indicators. Each category of indicator is discussed below.

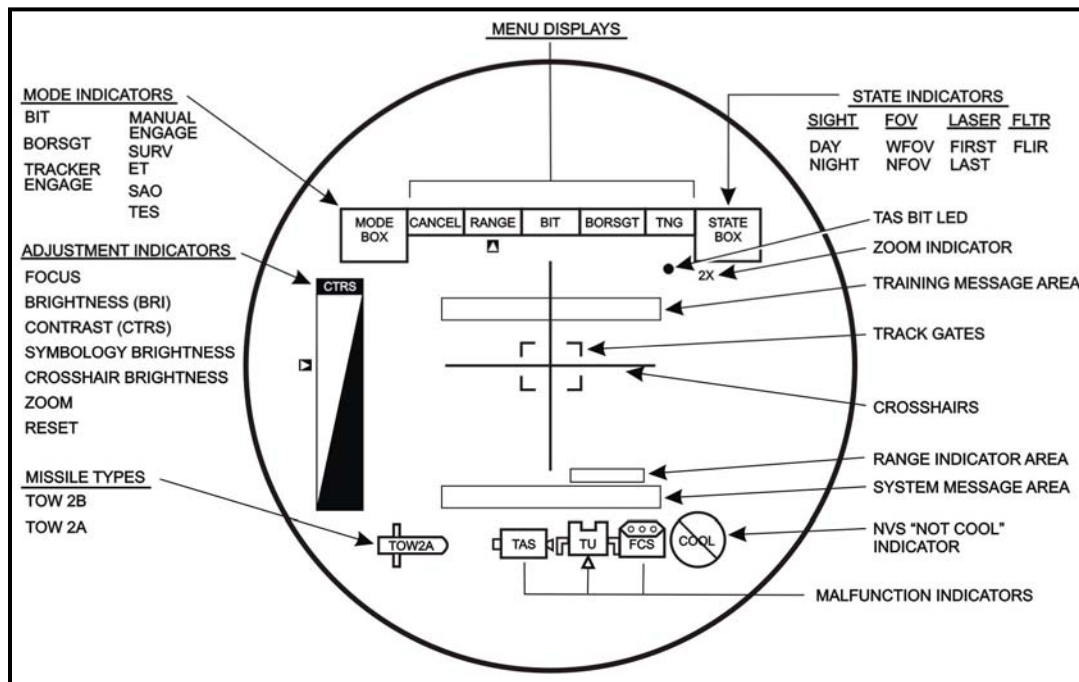
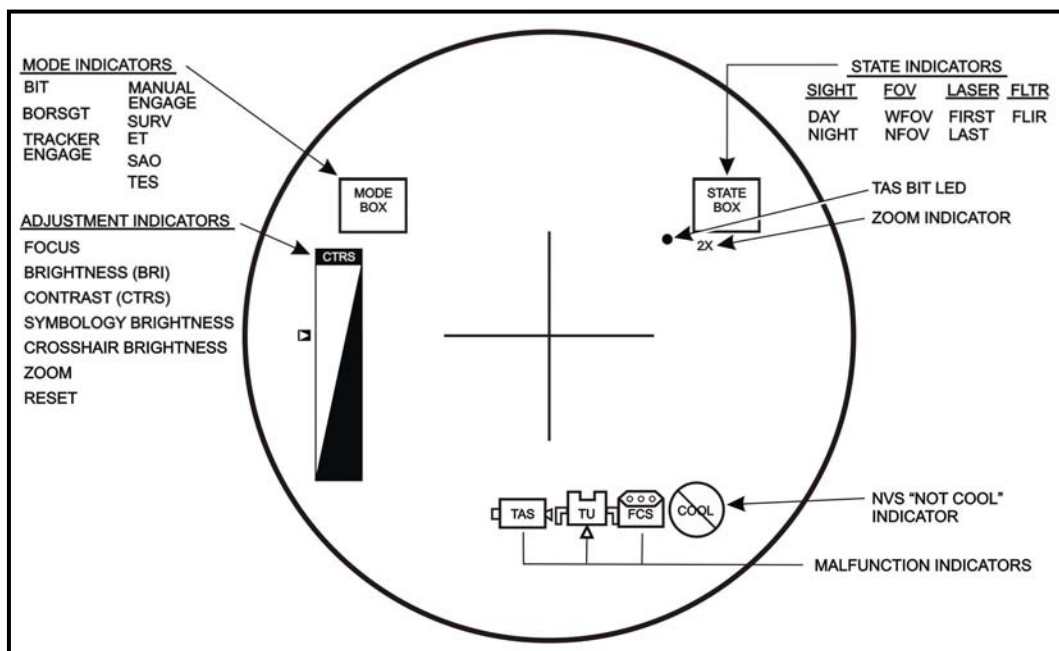


Figure 2-22. TAS indicators.

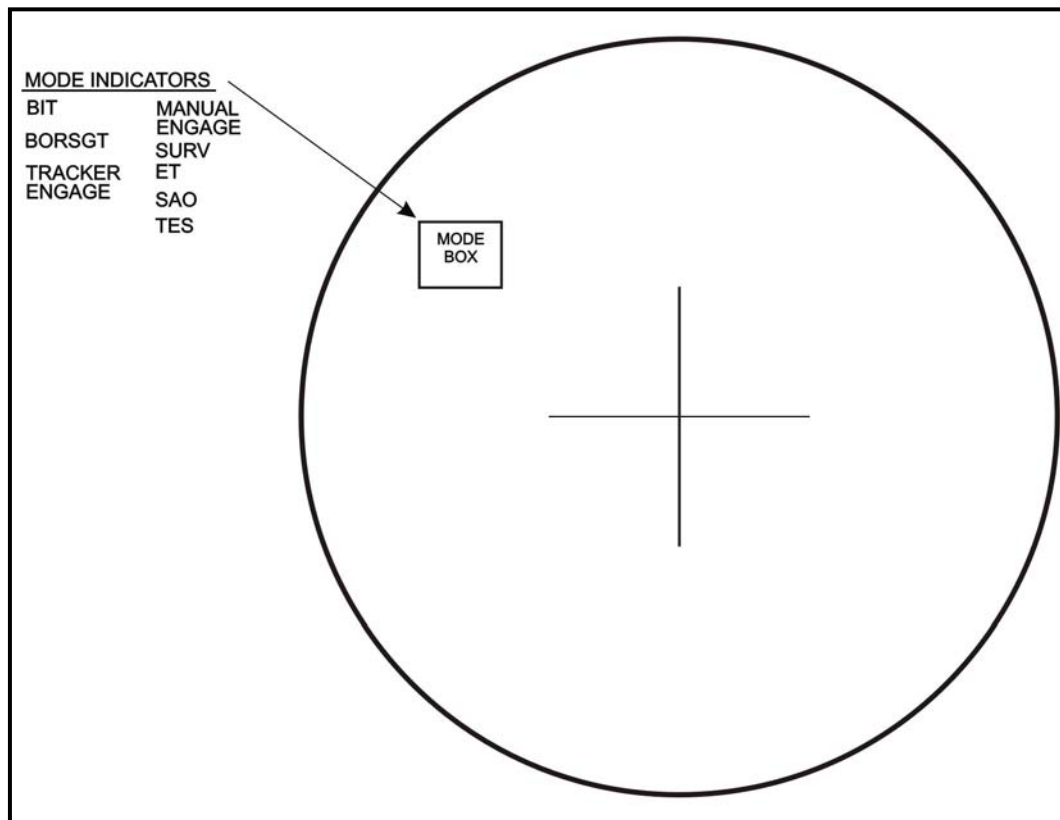
a. **STATUS Indicators.** These indicators identify ITAS operational modes, condition, and malfunctions. All of the status indicators are shown in Figure 2-23. The gunner, depending on the status of the ITAS, will see one or more of the status indicators.



**Figure 2-23. Status indicators.**

(1) **MODE Indicators.** The ITAS has five operational modes and three training modes. The operational or training mode selected by the gunner will be shown in the mode box on the TAS display (Figure 2-24). Modes of operation and training include:

- Built-in-test (BIT)—allows the gunner to verify proper operation of the ITAS.
- Boresight (BORSGT)—aligns the NVS, daysight, and LRF to the same point.
- Tracker engage (TRACKER ENGAGE)—tells the gunner the track gates are locked on.
- Manual engage (MANUAL ENGAGE)—indicates the missile is armed but the track gates are not activated.
- Surveillance (SURV)—indicates the missile is not armed and the track gates are not activated.
- Embedded training (ET)—indicates that embedded training has been initiated. Simulated missile fly out will occur.
- Sensor acquired objects (SAO)—indicates that embedded training was initiated and use of a missile simulation round is not required.
- Tactical engagement simulation (TES)—indicates that TES has been initiated, This is the mode used during force-on-force engagements and requires a field tactical trainer (FTT).
- Maintenance (MAINT)-indicates that the operator has chosen to view line replacement unit (LRU) codes and error codes.



**Figure 2-24. Mode indicators and mode box.**

(2) **STATE Indicators.** The ITAS has four state indicators (Figure 2-25, page 2-18) that provide status information on the system once its is placed into operation. Information about what state the system is currently operating in can be found in the state box of the TAS display. The gunner can change the system state by using the respective switches on the left handgrip control (Table 2-1, page 2-18).

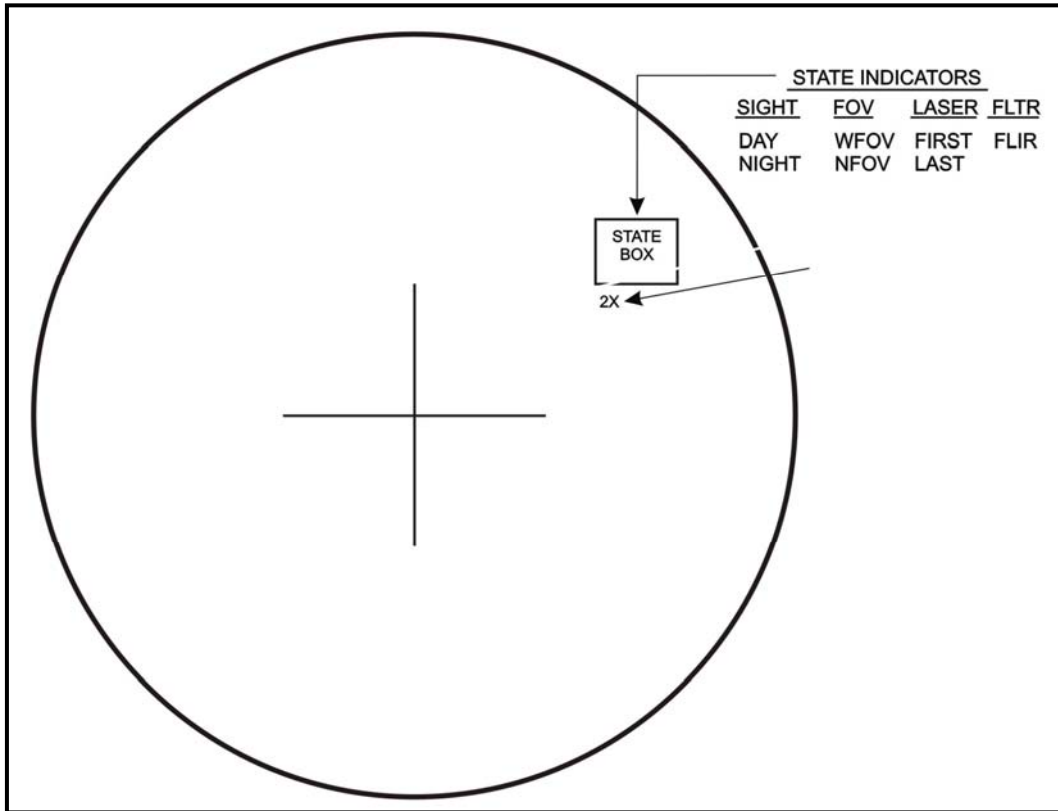


Figure 2-25. State indicators.

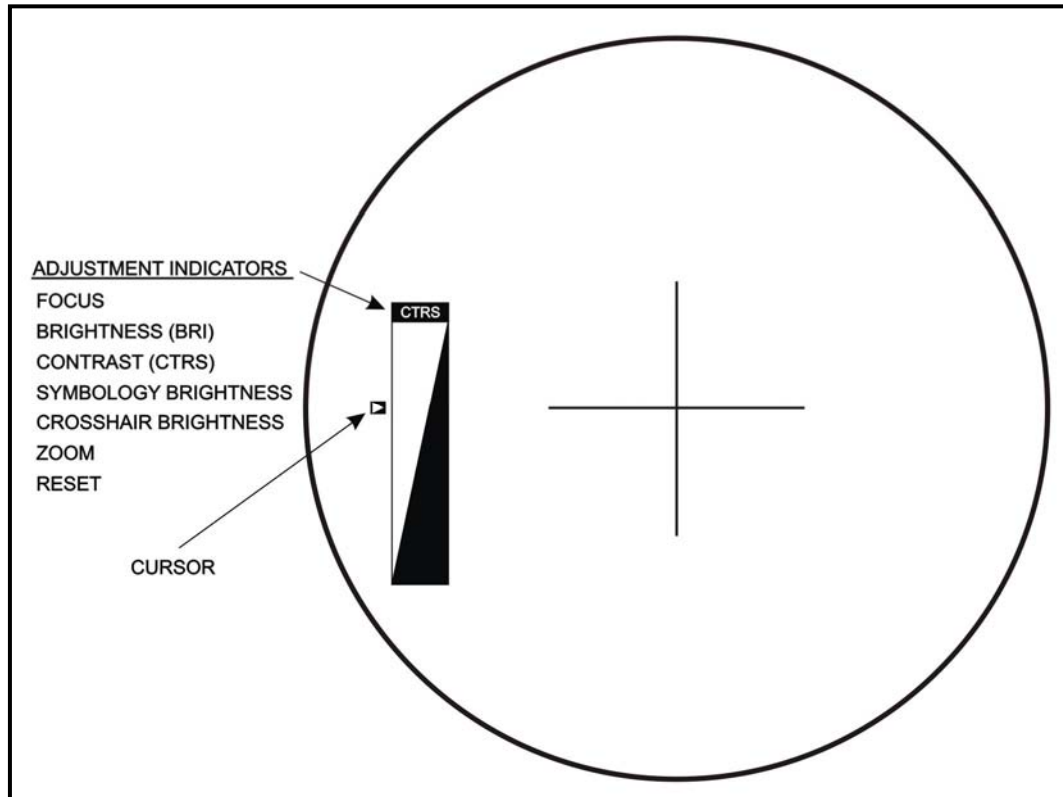
STATE INDICATOR	FUNCTION	LEFT HANDGRIP SWITCH	STATE BOX
SIGHT	DAY (daysight) NIGHT (NVS)	SGT SEL	DAY or NIGHT
FOV	WFOV or NFOV	FOV	WFOV or NFOV
LASER	FIRST or LAST RETURN	FIRST/LAST *	FIRST or LAST
FLTR 1	FILTER	FLTR	FLTR 1
ZOOM	DOUBLES MAGNIFICATION OF FIELD OF VIEW	BCF <sup>1</sup>	2X

\* Right handgrip control

<sup>1</sup> Selected BCF menu

Table 2-1. State indicators and corresponding left handgrip switch.

(3) **Adjustment Indicators.** These indicators give the gunner an indication of what adjustments he is making to the brightness, contrast, and focus of the NVS image; the brightness of the crosshairs; and the brightness of the TAS display symbols (Figure 2-26). The gunner can change the adjustments by using the BCF switch on the left handgrip control. The BCF switch is only operational with the TAS power switch in the ON position. NVS adjustments cannot be made until after the NVS has cooled down. Any change to the adjustments will be shown in the adjustment indicator box on the TAS display. A small cursor on the left side of the adjustment indicator box will indicate to the gunner whether he is increasing or decreasing the function selected for adjustment.



**Figure 2-26. Adjustment indicators with cursor.**

(a) Focus indicator (FOCUS) adjusts the focus of the NVS to compensate for the range to the target. The depth of field on the daysight is large enough that it does not need a range focus.

(b) Brightness indicator (BRT) adjusts the level of the NVS signal going to the TAS display to compensate for the coldest object of interest in the field of view.

(c) Contrast indicator (CTRS) adjusts the amplitude (gain) of the NVS signal going to the TAS display to compensate for the hottest object of interest in the field of view.

(d) Symbol brightness indicator (S BRT) adjusts the intensity of the text and symbols in the TAS display.

(e) Crosshair brightness indicator (C BRT) adjusts the intensity of the daysight crosshairs when the daysight is selected and the intensity of the NVS crosshairs when NVS is selected.

(f) Zoom (ZOOM) doubles the magnification of the NVS when it is in surveillance mode. If the track gates are selected or the missile is armed, the zoom will automatically revert to the NVS FOV listed in the state box.

(g) Reset (RESET) returns all NVS adjustments to their preset positions before power up.

(4) **Malfunction Indicators.** These indicators are NOT normally on during system operation (Figure 2-27). If, however, one of the systems built-in-tests finds a faulty component, the appropriate indicator will light on the TAS display.

(a) TAS indicator turns on if a malfunction occurs in the TAS.

(b) TU indicator turns on if a malfunction occurs in the TU.

(c) FCS indicator turns on if a malfunction occurs in the FCS.

(d) NVS NOT COOL indicator is located on the lower right corner of the TAS display. Once the TAS power switch is set to ON this symbol will come on and remain on until the NVS has cooled down (within 10 minutes). This is normal and does not indicate a malfunction unless it stays on longer than 10 minutes

(e) TAS BIT LED indicator illuminates when the power switch is moved from STANDBY to ON and remains illuminated during system PBIT. (This is **not** a malfunction.)

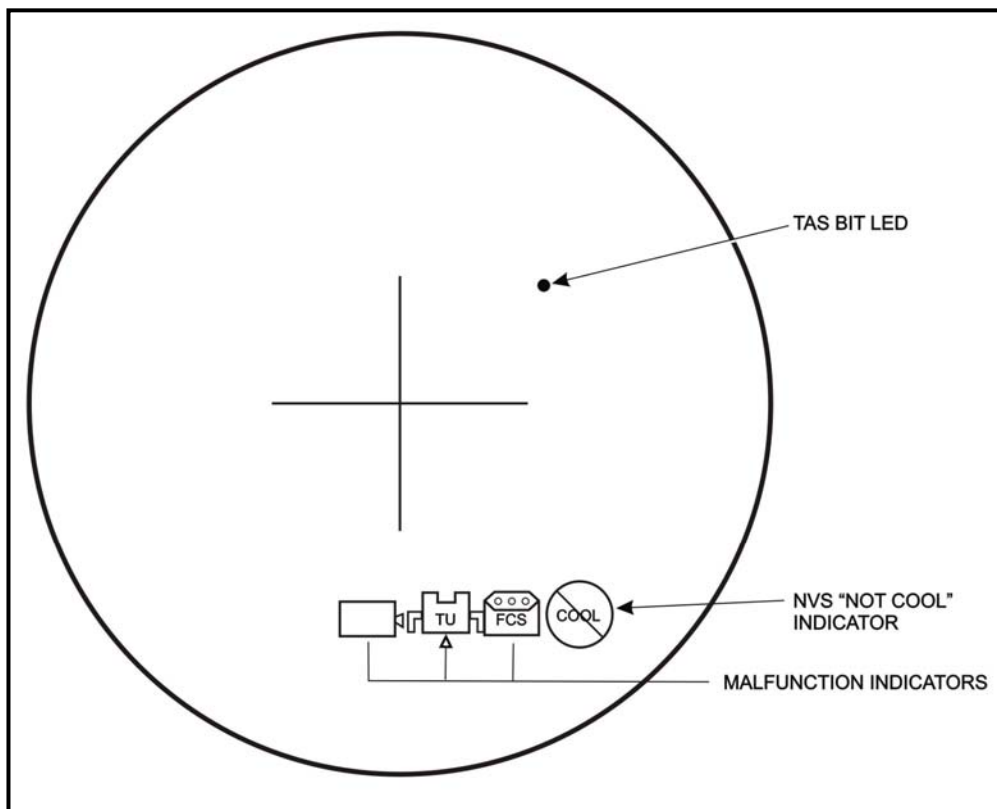
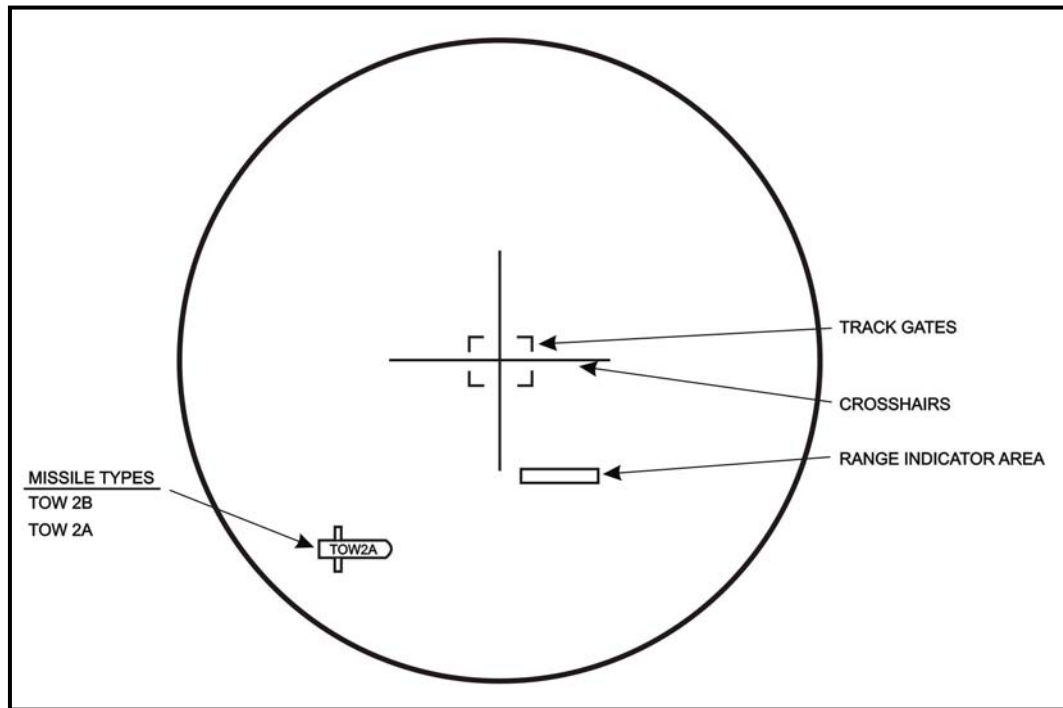


Figure 2-27. Malfunction indicators.



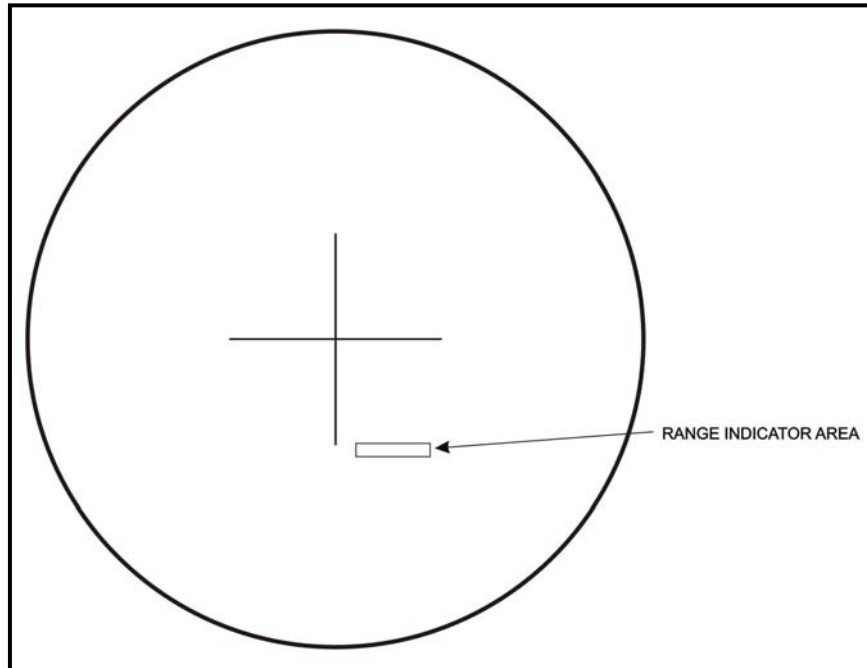
b. **Display Indicators.** The display indicators are used during target engagement both in manual and tracker mode. Display indicators for the TAS include missile types, range indicator area, crosshairs, and track gates (Figure 2-28).



**Figure 2-28. Display indicators.**

(1) **Missile Types Indicator.** This indicator tells the gunner what type of missile has been loaded and armed in the launch tube. A missile type indicator is displayed on the lower left side inside the TAS as a symbol of a TOW missile (Figure 2-28).

(2) **Range Indicator Area.** The range to the target (in meters) is displayed in this area whenever the gunner uses either active or passive ranging (Figure 2-29, page 2-22).

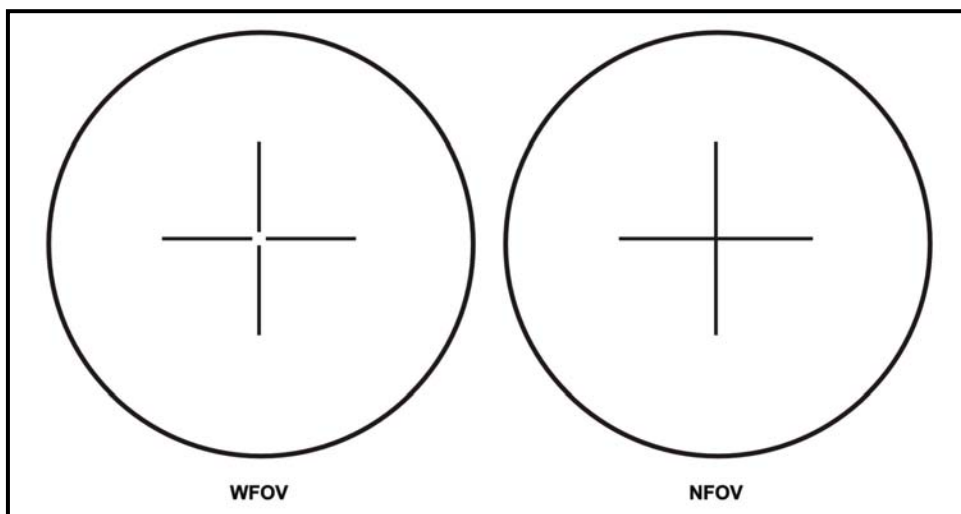


**Figure 2-29. Range indicator area.**

(3) **Crosshairs.** Crosshairs provide the gunner a reference point to align the TAS with a target. In the daysight, the crosshairs are generated using backlighting in the TAS. In NVS, the crosshairs are part of the symbols generated by the FCS.

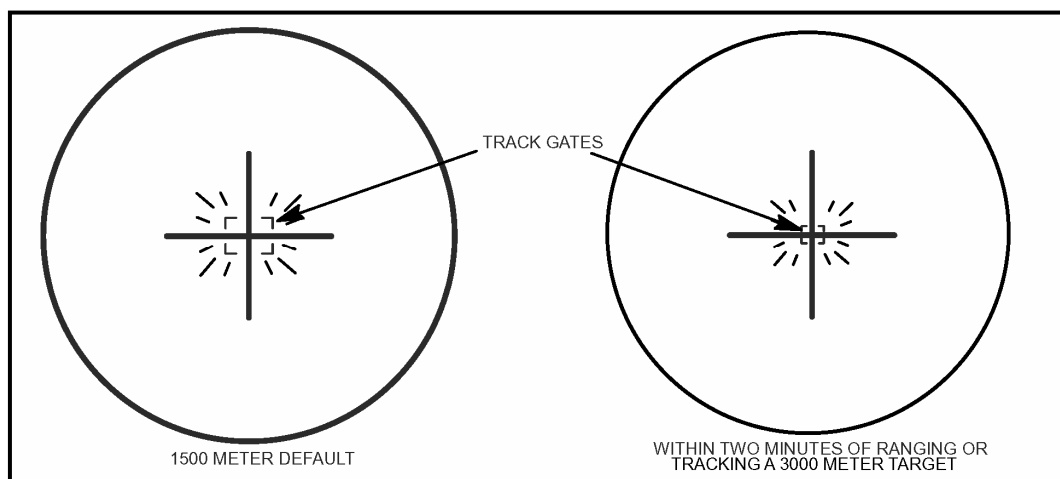
(a) **WFOV Crosshairs.** The WFOV crosshairs cover one third of the display and indicate the area that will be shown when the gunner switches to NFOV (Figure 2-30). The crosshairs intersect at the point where the missile will hit.

(b) **NFOV Crosshairs.** The NFOV crosshairs cover the whole display and intersect at the point where the missile will hit (Figure 2-30).



**Figure 2-30. Crosshairs.**

(4) **Track Gates.** When the gunner presses the TRK GTE switch, four box corners called track gates appear on the TAS display (Figure 2-31). The tracker located in the FCS generates the track gates. The gunner adjusts the track gates around the target and commands the tracker to lock onto the target. The track gates first come up flashing and sized for a tank at 1,500 meters unless a target has been ranged or tracked within the past two minutes. The track gates will stop flashing and become solid after the gunner commands lock on.

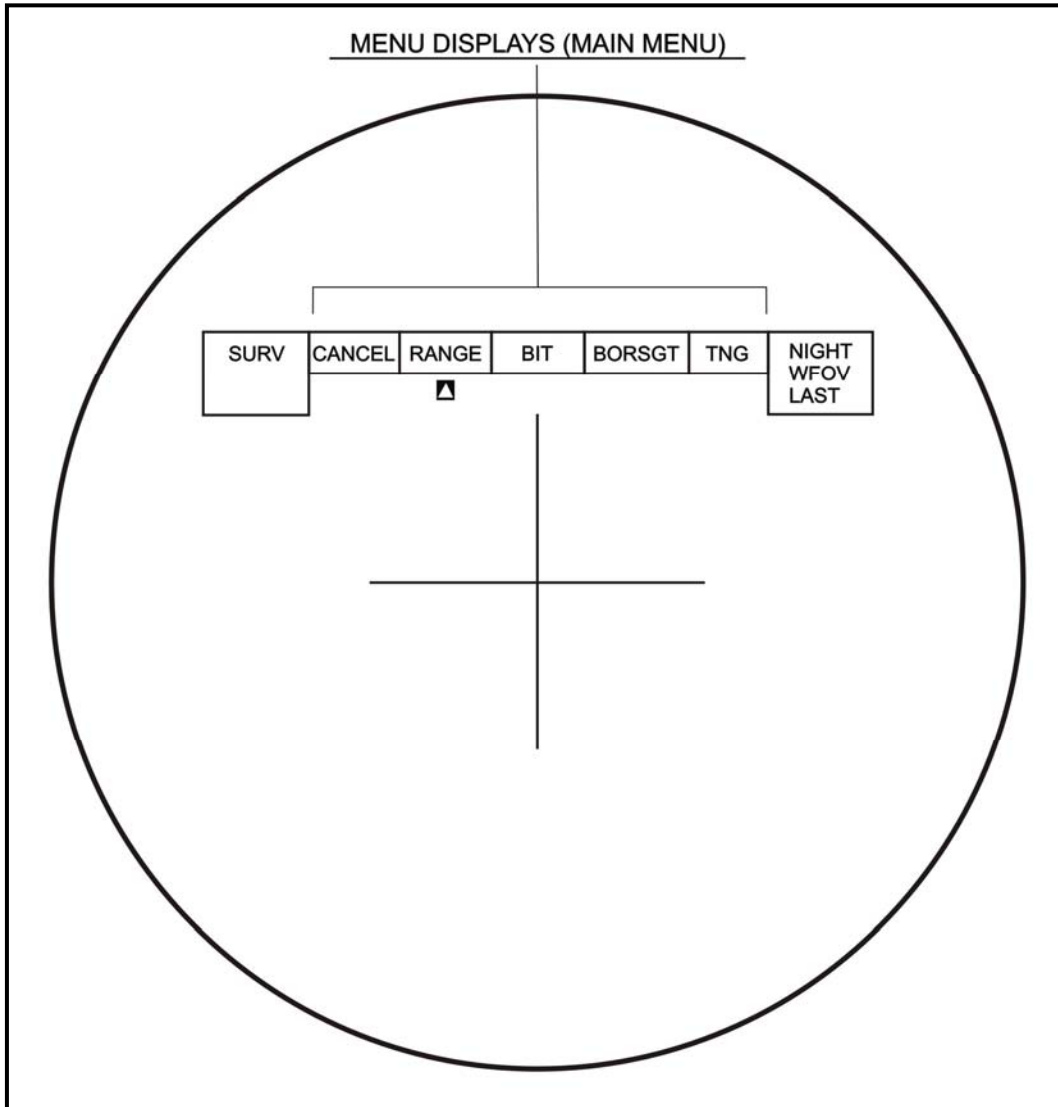


**Figure 2-31. Track gates.**

c. **Menu Display Area.** During system operations in combat or training, various menus can be displayed on the TAS display by pressing the MENU switch on the left handgrip control. After a menu is displayed (Figure 2-32, page 2-24), the gunner can select any of the options displayed by moving the menu switch left or right, causing a cursor to move to that function. The gunner then presses the MENU switch again to activate the function selected.

(1) **Main Menu.** The main menu is the first menu the gunner will see when he presses the MENU switch (Figure 2-32, page 2-24). The main menu has five options:

- CANCEL. Selecting cancel will remove the main menu from the TAS display.
- RANGE. Selecting RANGE brings up the range menu, which allows the gunner to determine range to a target without using the LRF.
- BIT. Selecting BIT brings up the BIT menu.
- Boresighting (BORSGT). Selecting BORSGT brings up the boresight menu.
- Training (TNG). Selecting TNG brings up the training menu.

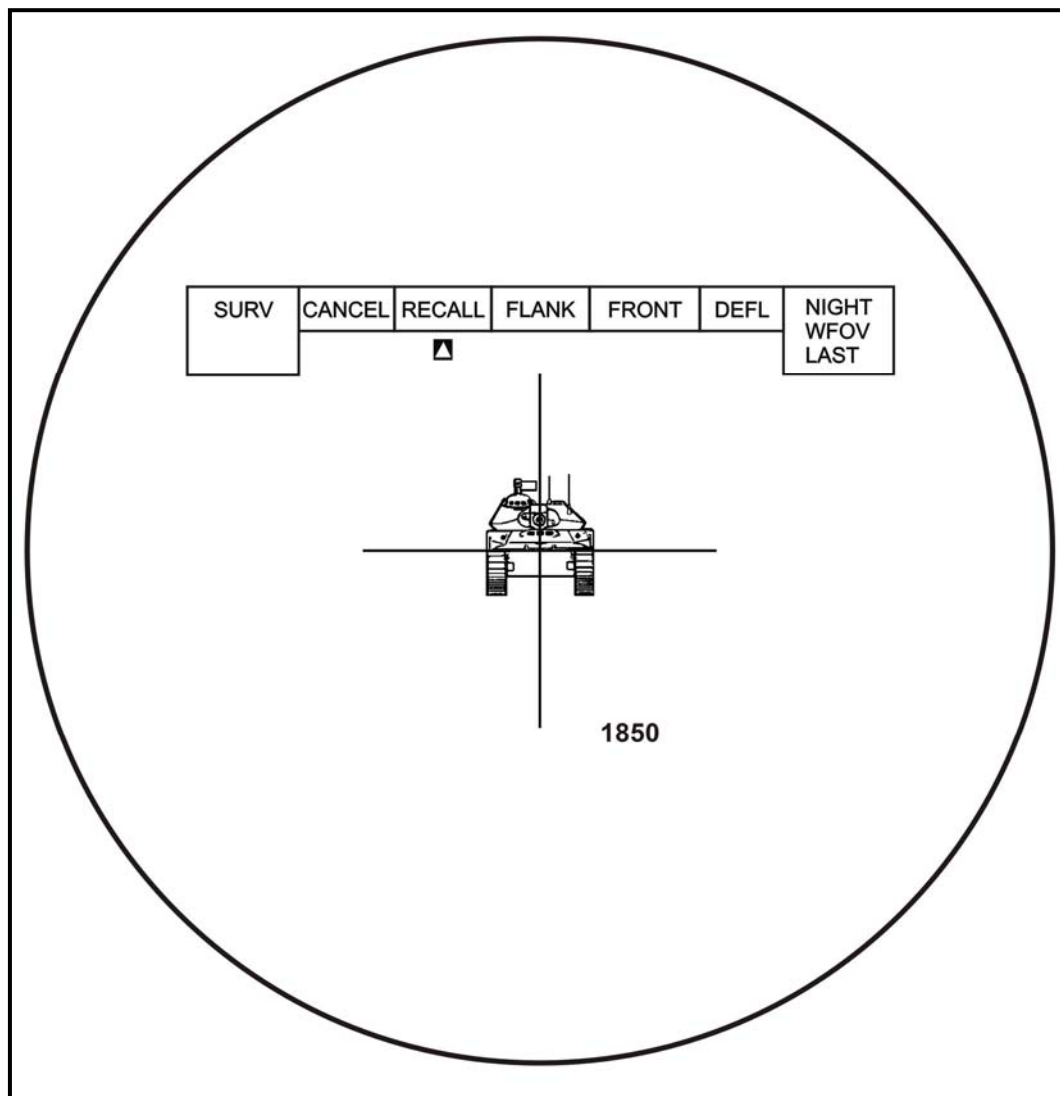


**Figure 2-32. Menu display area/main menu.**

(2) **Range Menu.** The range menu is displayed when the gunner selects RANGE from the MAIN MENU. The primary purpose of this menu is to give the gunner the capability to passively determine range to a target without using the LRF (Figure 2-33). The gunner can determine the range for flank, front/rear, and hull defilade targets. The range menu has five selections:

- CANCEL. Selecting CANCEL will remove the range menu from the TAS display.
- RECALL. Selecting RECALL recalls the last LRF ranging in meters (active) stored in the FCS memory (for example, 1,850 meters as in Figure 2-33). If more than two minutes have passed since the last ranging, the range indicator area will display zero (0).
- FLANK. Selecting flank determines range to a flank target.

- FRONT. Selecting front determines the range to a frontal or rear view target.
- DEFIL. Selecting DEFIL (defilade) determines the range to a target in a hull defilade position.

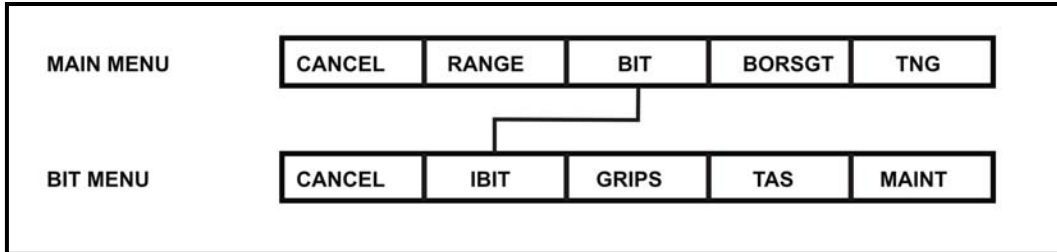


**Figure 2-33. RANGE menu selections.**

(3) **BIT Menu.** The BIT menu displays when the gunner selects BIT from the MAIN MENU. The primary purpose of this menu is to conduct the initiated built-in test (IBIT) during system checkout procedures (Figure 2-34, page 2-26). The BIT menu has five selections:

- CANCEL. Selecting CANCEL will remove the BIT menu from the TAS display.
- IBIT. Selecting IBIT will run the initiated built-in test.
- GRIPS. Selecting GRIPS will display on-screen instructions for the gunner to follow in testing selected ITAS components.

- TAS. Maintenance personnel use this selection.
- MAINT. Selecting MAINT will bring up a maintenance menu. The gunner uses this selection when entering mission critical and non-mission critical faults on DA Form 2404 (Equipment Inspection and Maintenance Worksheet).



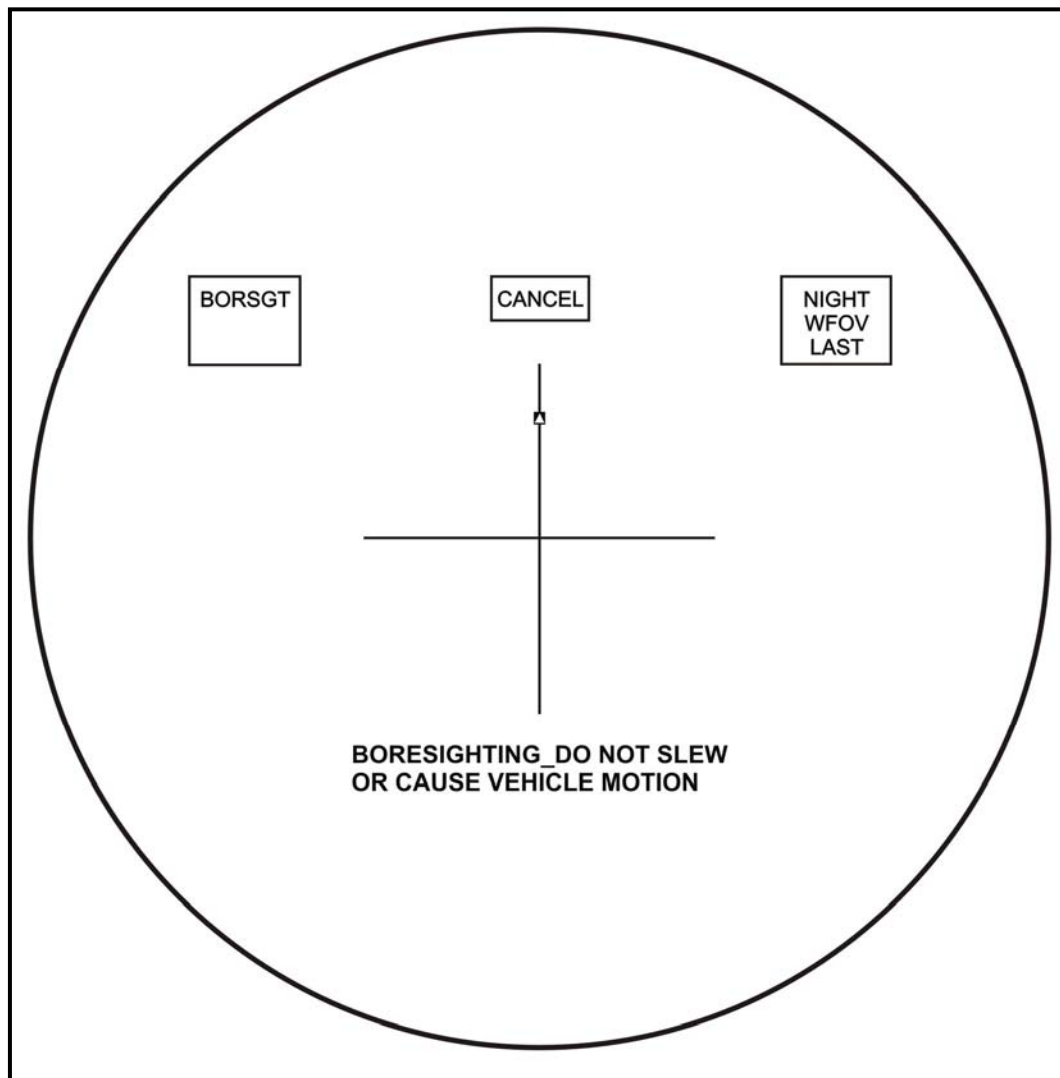
**Figure 2-34. BIT menu tree.**

(4) ***BORSGT Menu.*** Automatically boresight the daysight, the NVS, and the LRF when BORSGT is selected from the main menu.

**NOTE:** Boresighting is normally done during system checkout. However, during extreme temperature changes,  $\pm 18$  degrees Fahrenheit, the message TAS TEMP HAS CHANGED - PERFORM BORESIGHT may appear requiring the gunner to boresight the ITAS again.

(a) Selecting BORSGT from the main menu initiates the automatic boresighting. Once the gunner selects the boresight procedure, the word BORSGT will appear in the mode box, and the boresighting process starts.

(b) While boresighting is in progress, the message BORESIGHTING - DO NOT SLEW OR CAUSE VEHICLE MOTION is displayed in the TAS system message area (Figure 2-35).



**Figure 2-35. BORS GT message.**

(c) When boresighting is completed, the message BORESIGHT COMPLETE will be displayed for five seconds and the TAS display will return to the FOV being used before boresighting was initiated.

(d) If excessive motion is detected, the message REDO BORESIGHT EXCESSIVE MOTION will be displayed.

(e) If the system cannot boresight itself, the message UNABLE TO BORESIGHT - MAINTENANCE REQUIRED will appear. The gunner turns notifies his chain of command so that the ITAS can be turned in for maintenance as soon as possible.

**NOTE:** The CANCEL menu box remains up to allow the gunner to abort at any time during the boresighting procedures.

(5) **TNG Menu.** The training menu is displayed when the gunner selects TNG from the main menu. This menu displays and provides access to the built-in ITAS training

modes. The training menu consists of CANCEL and four other selections (Figure 2-36). From left to right they are: SAO, ET, TES, and BIT.

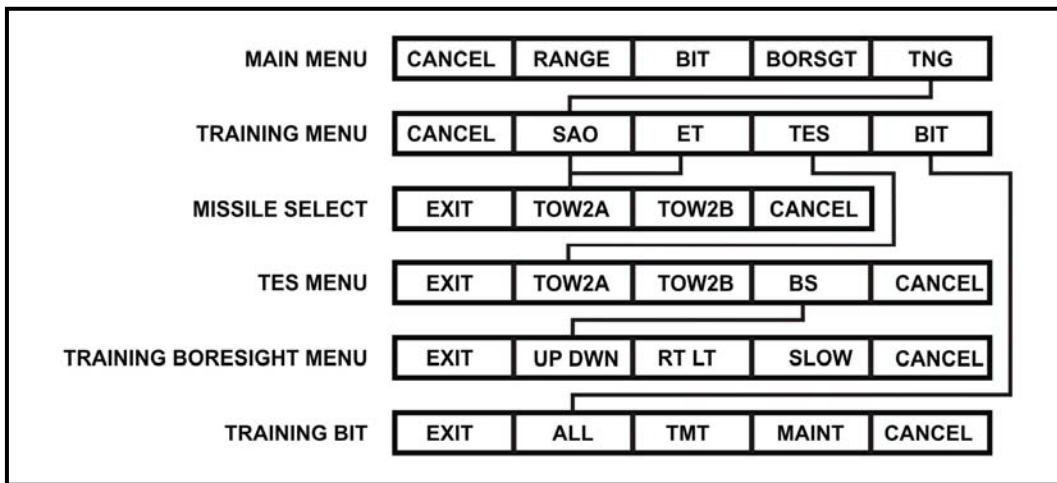


Figure 2-36. Training menu tree.

(a) *CANCEL*. Selecting CANCEL removes the training menu and cancels the training mode.

(b) *SAO*. The SAO mode allows training without a missile simulation round in the launch tube. The selection of SAO from the training menu calls up a lower-level menu, missile select, with the following options: EXIT, TOW2A, TOW2B, and CANCEL (Figure 2-37).

- EXIT will return the gunner to the training menu and cancel the SAO mode selection.
- TOW2A or TOW2B will initiate the SAO mode, remove the training menu, and place SAO in the mode box (Figure 3-38).
- CANCEL will remove the missile select menu from the TAS display.

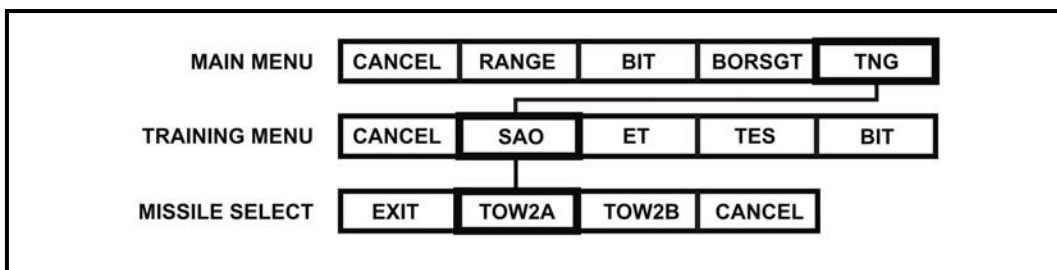
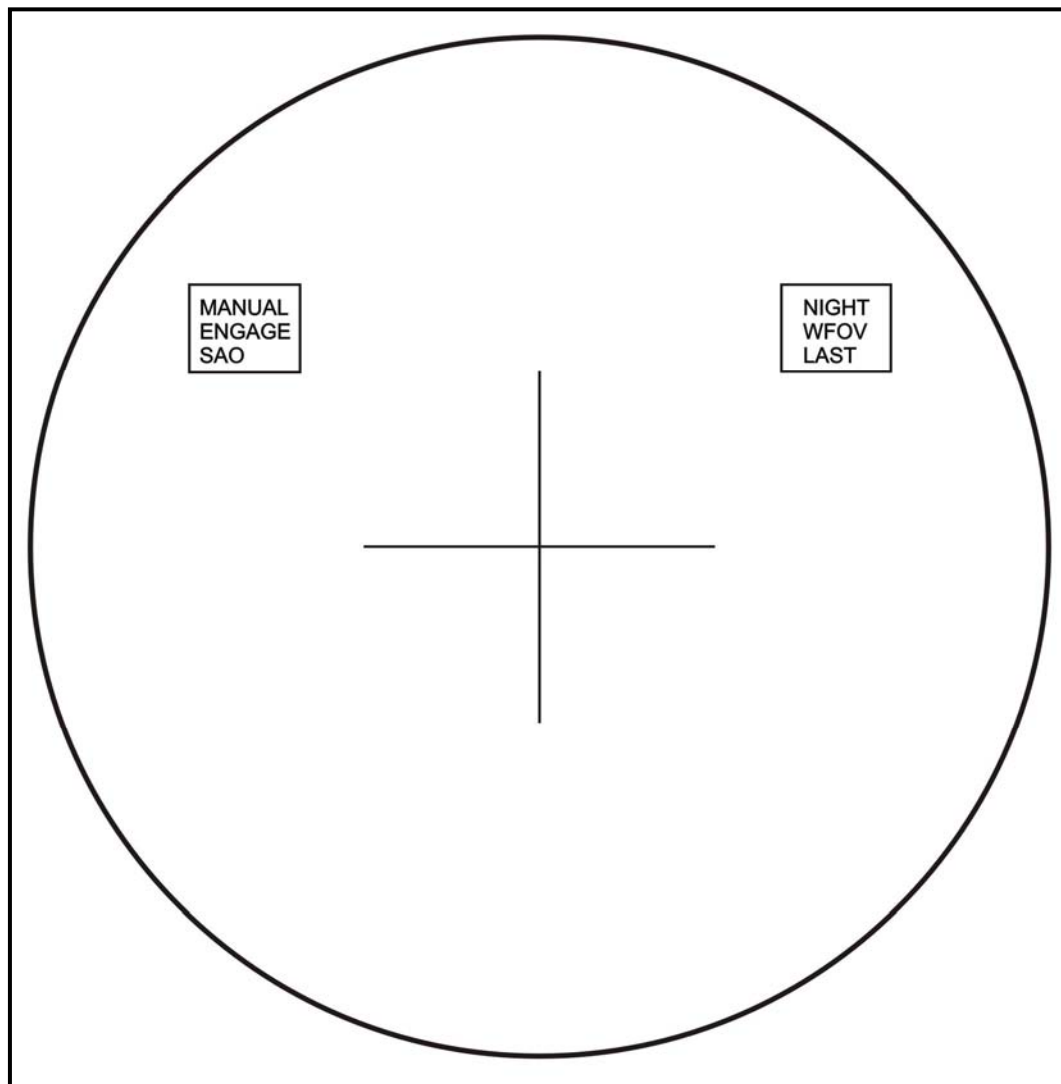


Figure 2-37. SAO training menu selections.





**Figure 2-38. SAO display.**

(c) *ET*. This mode allows training with a missile simulation round in the launch tube. The selection of *ET* from the training menu calls up a lower-level menu, missile select, with the following options: *EXIT*, *TOW2A*, *TOW2B*, and *CANCEL* (Figure 2-39, page 2-30).

- *EXIT* will return the gunner to the training menu and cancel the *ET* mode selection.
- *TOW2A* or *TOW2B* will initiate the *ET* mode, remove the training menu, and place *ET* in the mode box (Figure 2-40, page 2-30).
- *CANCEL* will remove the missile select menu from the TAS display.

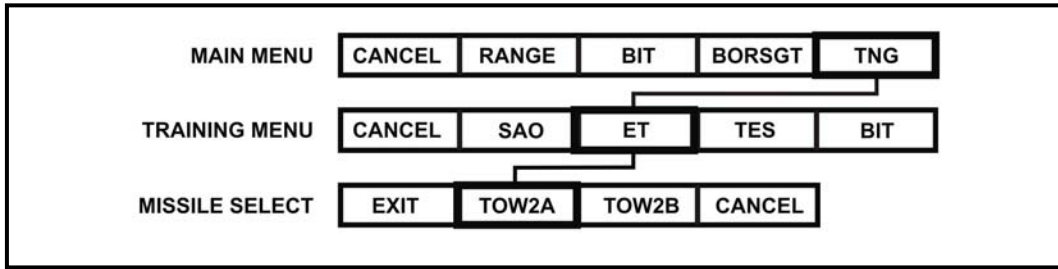


Figure 2-39. ET training menu selections.

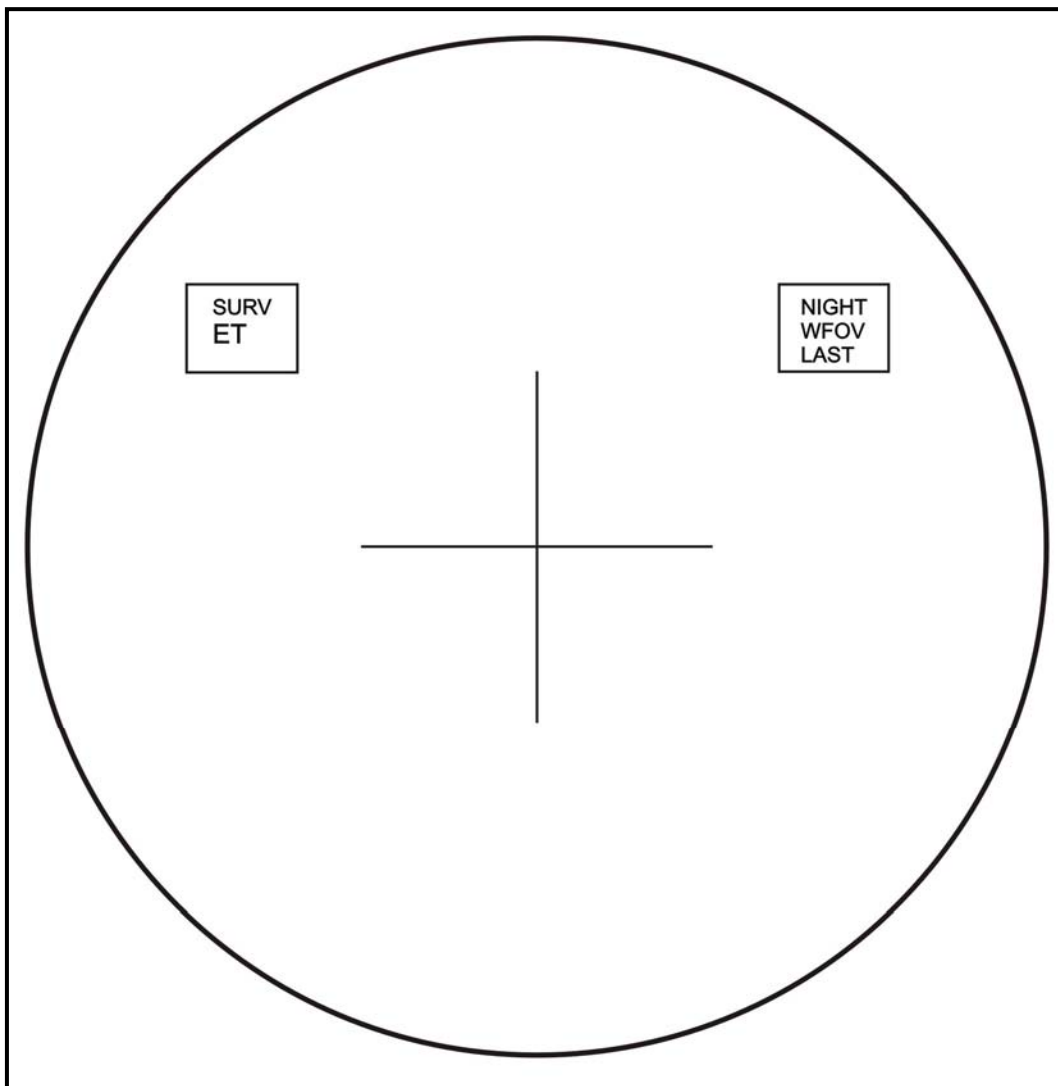


Figure 2-40. ET display.

(d) *TES*. This mode allows force-on-force training with the use of a training missile tube in the launch tube. The selection of *TES* from the training menu calls up a

lower-level menu, TES, consisting of EXIT, TOW2A, TOW2B, BS (boresight), and CANCEL (Figure 2-41).

- EXIT will return the gunner to the training menu and cancel the training BIT mode selection.
- TOW2A or TOW2B will initiate TES, remove TES menu, and cause TES to appear in the mode box (Figure 2-42).
- BS calls up the training boresight menu, a lower level menu consisting of EXIT, UP DWN, RT LT, SLOW, and CANCEL.
- CANCEL will remove the TES menu from the TAS display.

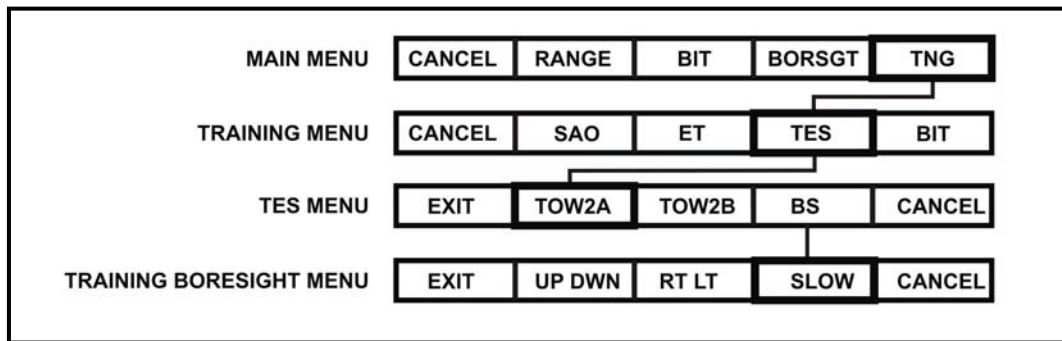


Figure 2-41. TES training selections.

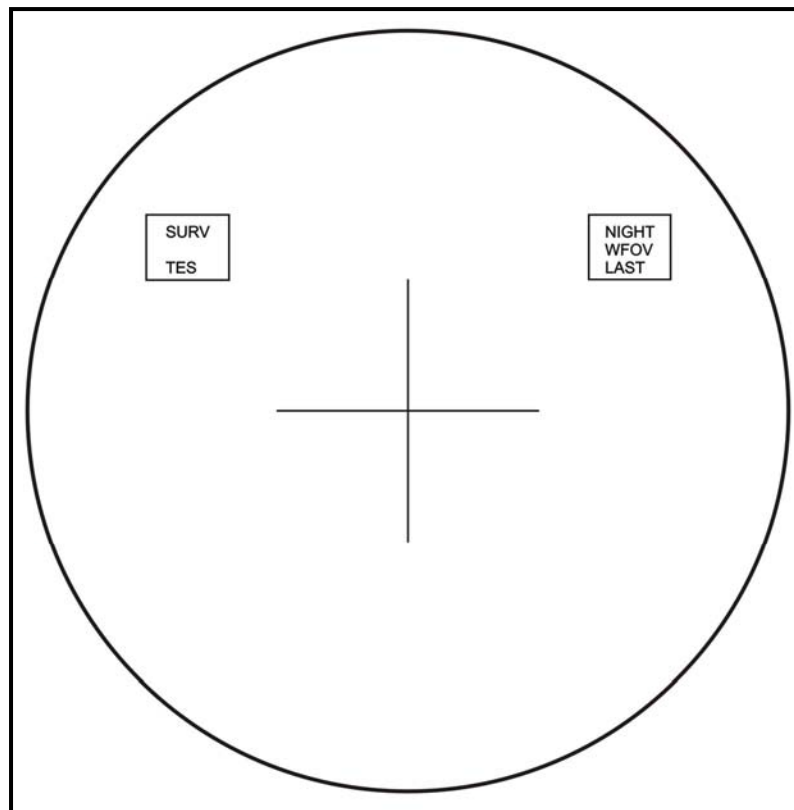
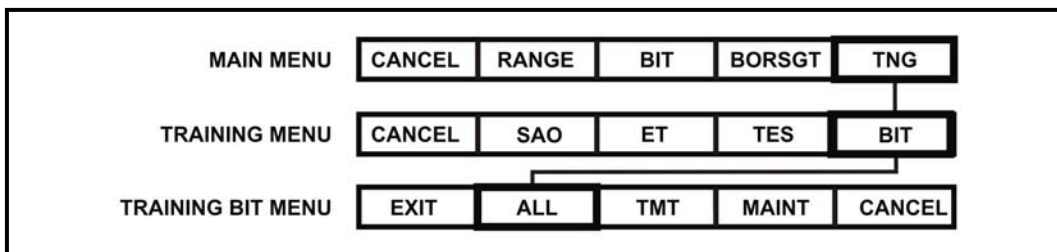


Figure 2-42. TES display.

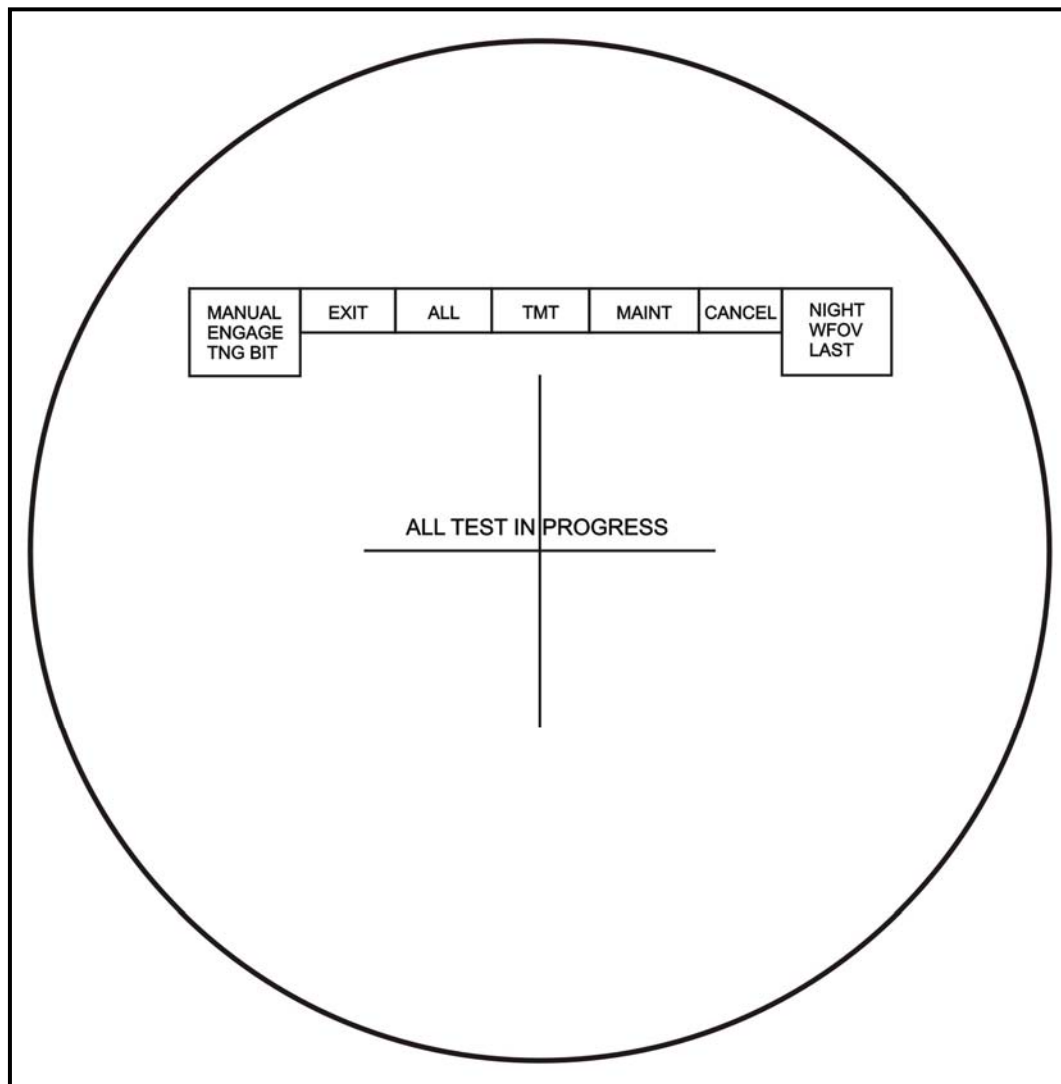
**NOTE:** See TM 9-6920-721-10 for detailed information on use of the TES mode in conjunction with force-on-force training.

(e) *BIT*. This mode allows built-in checks of the training missile tube (TMT) when installed in the launch tube. This mode is used before placing the FTT into operation. The selection of BIT from the training menu calls up a lower-level menu, training BIT, consisting of EXIT, ALL, TMT, MAINT, and CANCEL (Figure 2-43).

- EXIT will return the gunner to the training menu and cancel the TES BIT mode selection
- ALL or TMT will initiate FTT BIT check, highlight the appropriate BIT menu box, and place TNG BIT in the mode box (Figure 2-44). If BIT passes, the menu transitions to the training menu and TNG BIT is removed from the mode box. If either BIT fails, the BIT menu is retained, the highlight is removed, and the cursor is positioned at the MAINT box
- MAINT is not to be selected by the gunner or crewmembers.
- CANCEL will remove the training BIT menu from the TAS display.



**Figure 2-43. Training BIT menu selections.**



**Figure 2-44. TAS display.**

(6) **Message Display Area.** The TAS display shows two types of messages: system and training.

(a) **System Messages.** At the lower center of the TAS display is a line for messages that are generated by the FCS. The ITAS has instructions loaded into its computer that can be sent to the gunner as operational and maintenance messages that indicate information or actions to take. An example of a message the gunner may receive during a target engagement is SELECT NVS BEFORE SELECTING TARGET TRACKER (Figure 2-45, page 2-34).

(b) **Training Messages.** The gunner can also receive training messages. Training messages are in a separate area to prevent a training message from overwriting a system message; however, training messages can only appear if the training mode has been selected (Figure 2-46, page 2-34).

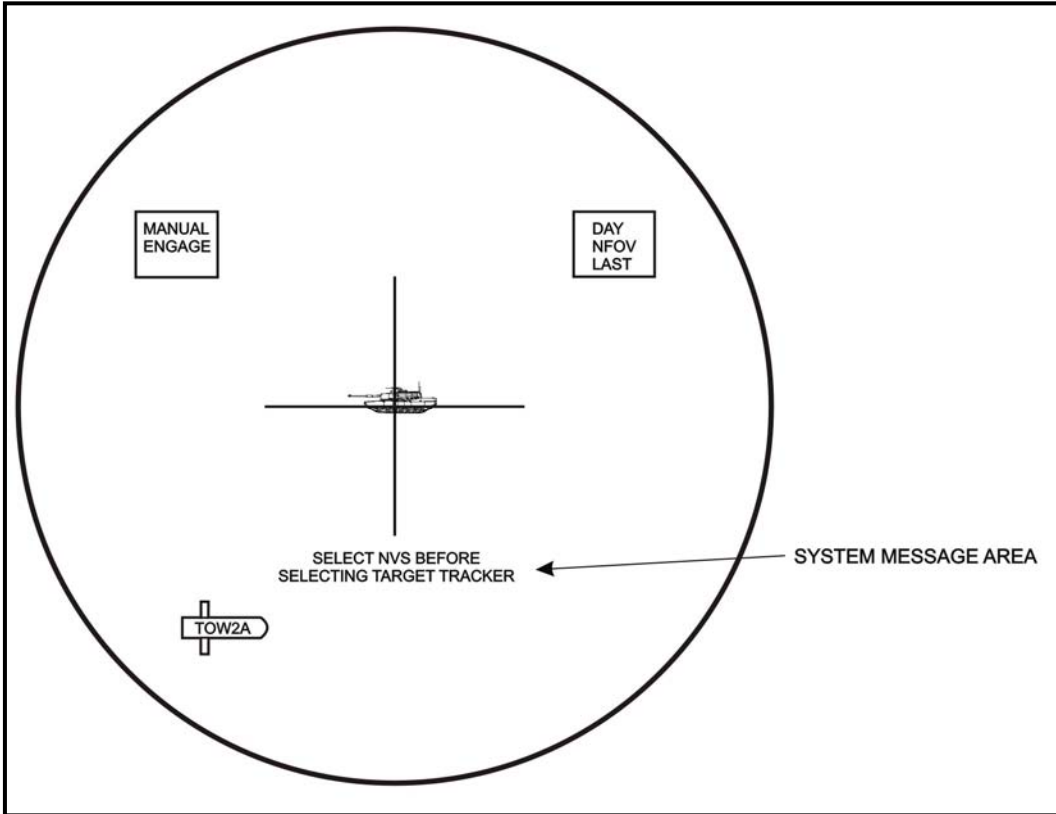


Figure 2-45. System message display area.

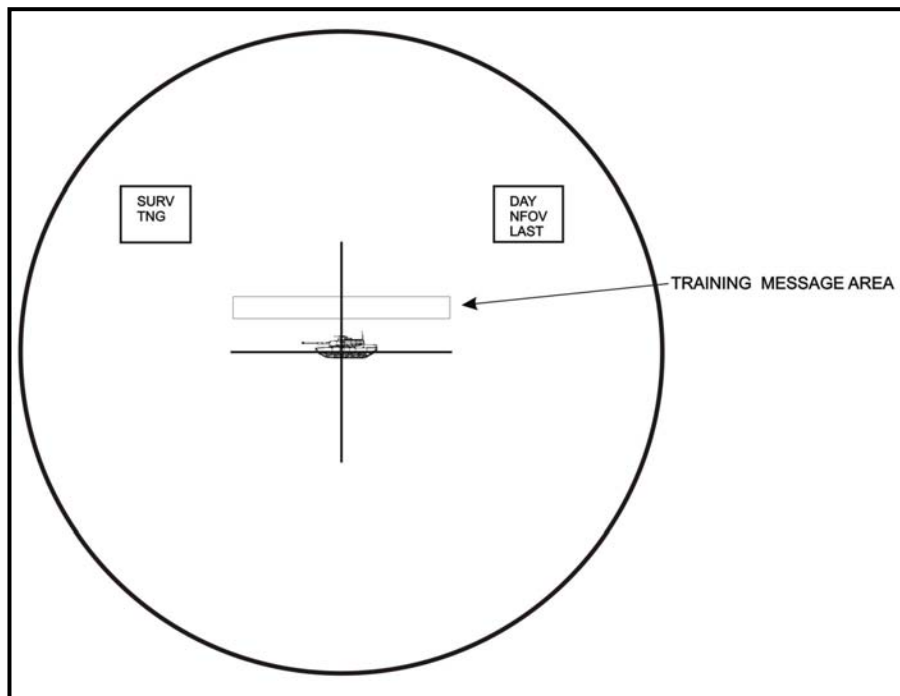


Figure 2-46. Training message display area.

## 2-5. FIRE CONTROL SYSTEM CONTROLS AND INDICATORS

The FCS contains the ITAS computer and associated control electronics (Figure 2-47).

a. **FCS Power Switch.** The power switch is located under a cover to protect it from being accidentally turned off. The FCS power switch is turned on after the BPS power switch in the ITAS power-up procedures.

b. **FCS BIT Indicator Lamp.** The FCS BIT indicator lamp will come on if the FCS malfunctions. Turning the lamp bezel controls the brightness of the lamp.

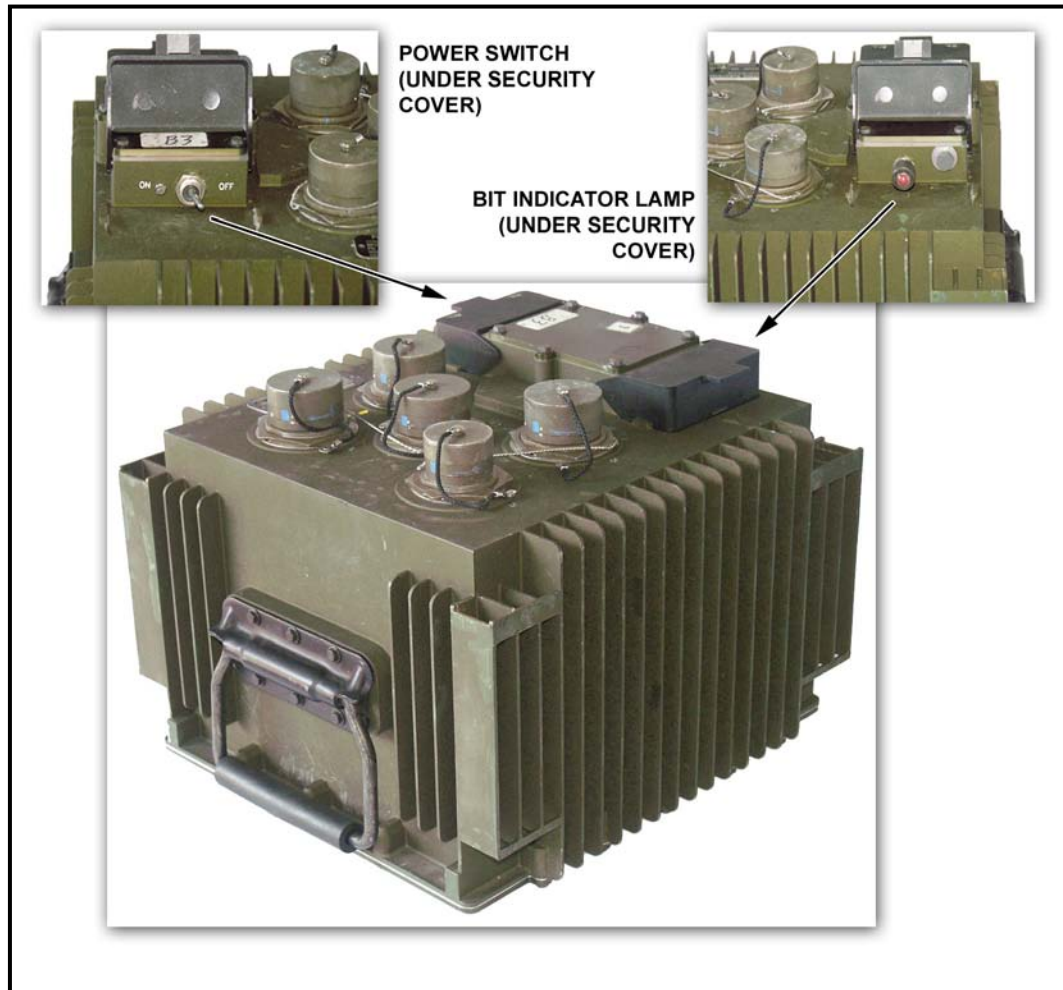


Figure 2-47. FCS power switch and BIT indicator lamp.

## 2-6. BATTERY POWER SOURCE CONTROLS AND INDICATORS

The BPS operates the ITAS when it is mounted on a tripod, and acts as a power conditioner for the vehicle power when mounted on the M1121 HMMWV. When vehicle power drops below 23.5 volts BPS internal power, the TAS and BPS INTERNAL will be displayed inside the TAS.

a. **BPS Display.** The BPS display is located in the lower right corner of the BPS. This display provides readouts for operator and maintenance personnel. The display brightness is varied by pressing the INCR switch to increase the brightness and the

DECR switch to decrease the brightness when the function switch is in any position except SET or BIT (Figure 2-48).

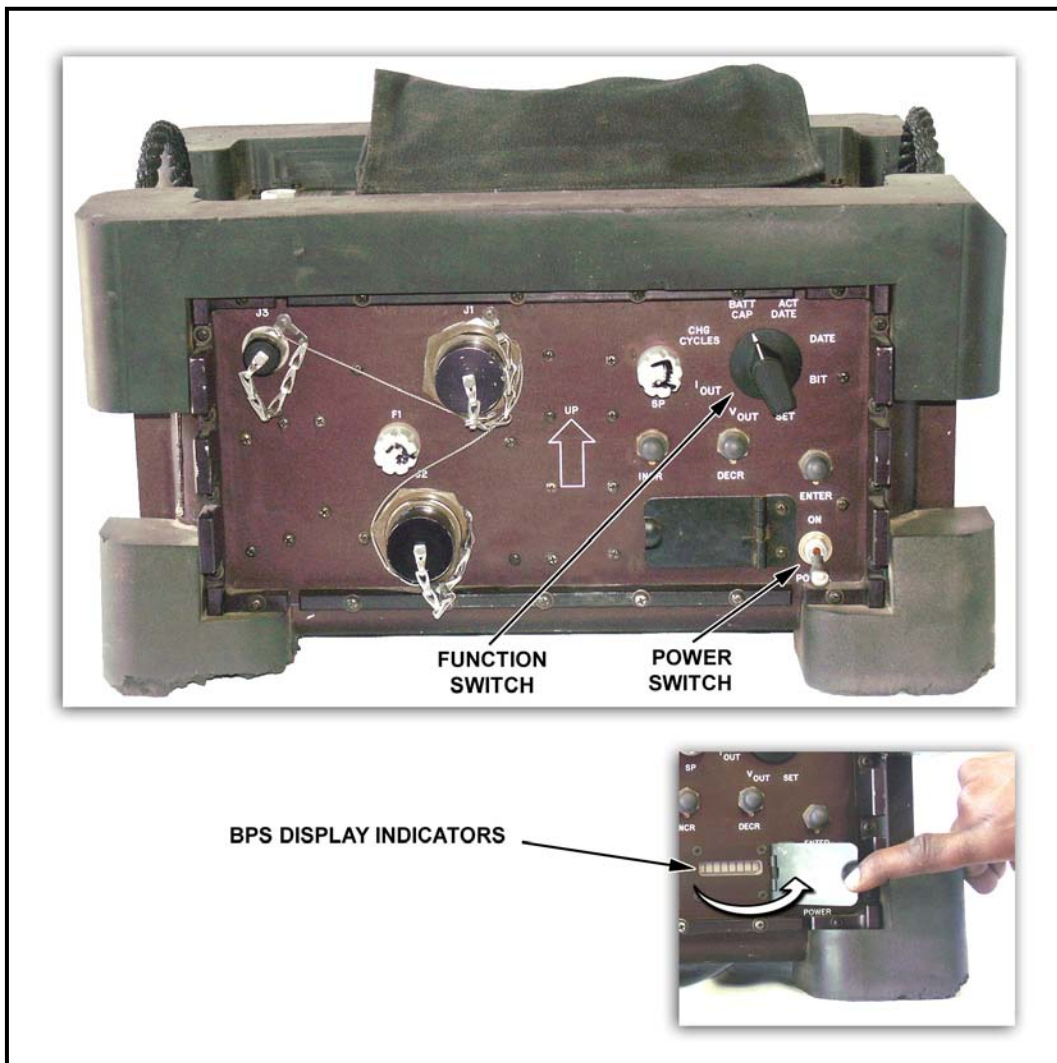


Figure 2-48. Battery power source controls and indicators.

**CAUTION**

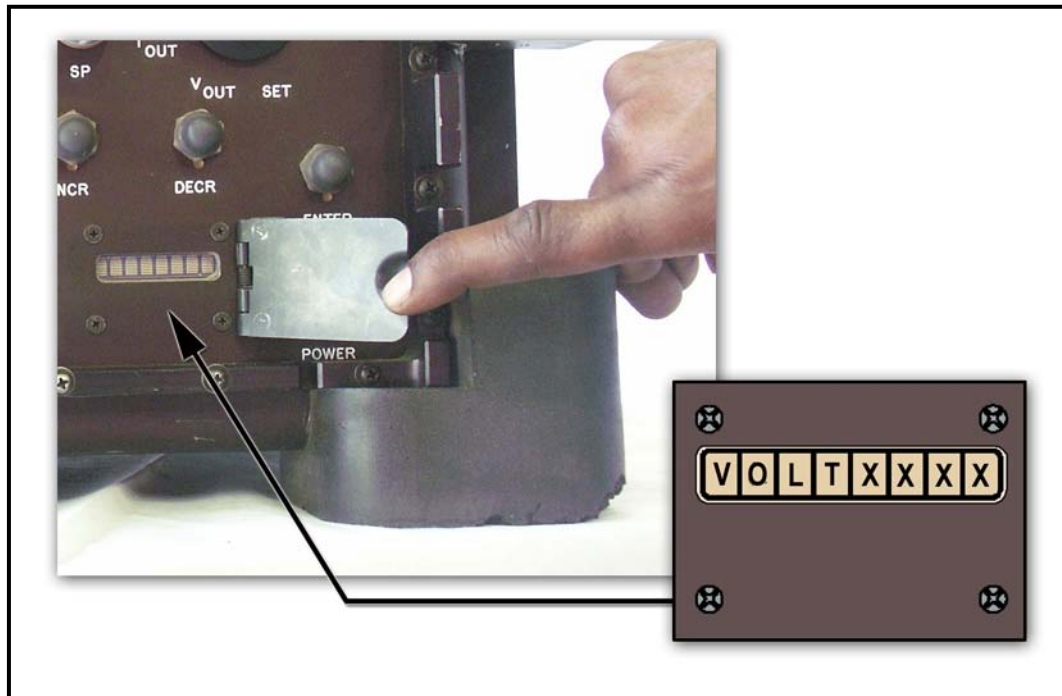
Setting the BPS in any orientation other than that indicated by the UP arrow may cause the battery electrolyte to leak out causing injury to personnel and damage to equipment.

b. **BPS Controls.** Located on the front of the BPS are five control switches. The operator uses these controls to determine the status and capacity of the batteries within the BPS.



(1) **Function Switch.** The function switch controls what is displayed on the BPS display. The function switch is an eight-position rotary switch located in the upper right corner of the BPS (Figure 2-48).

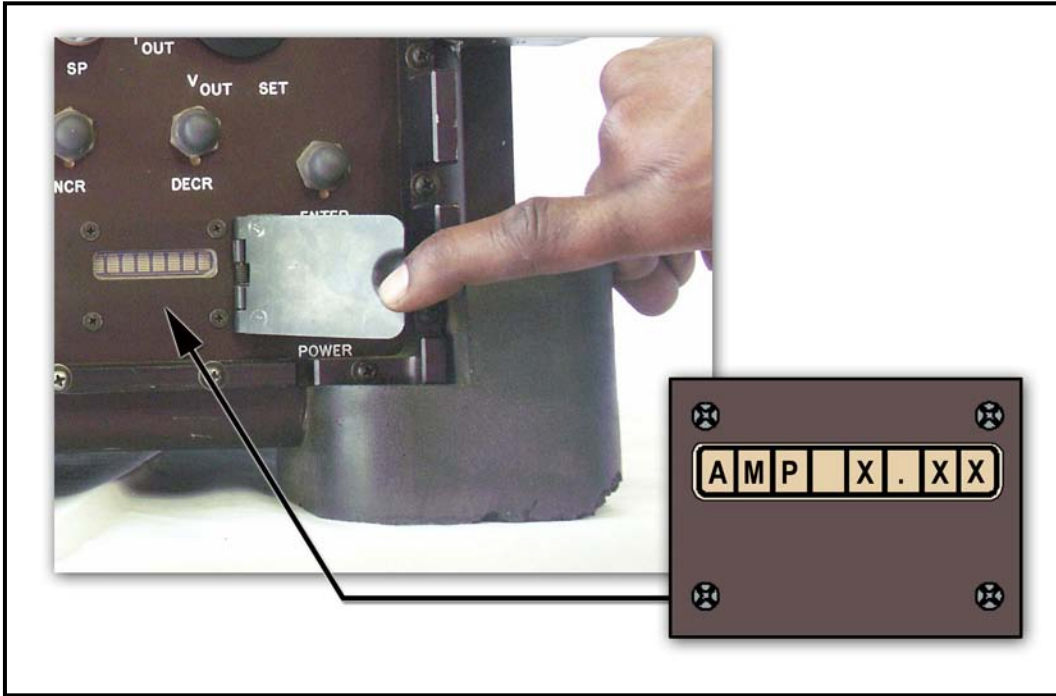
(a)  $V_{OUT}$ . When the function switch is placed in the  $V_{OUT}$  position, the amount of output voltage available can be checked.  $V_{OUT}$  should read between 24 to 31 VDC when the BPS batteries are charged. The BPS display window will display the current voltage of the BPS (Figure 2-49).



**Figure 2-49. BPS displays current voltage.**

(b)  $I_{OUT}$ . When the function switch is placed in the  $I_{OUT}$  position, the amount of current being supplied to the ITAS can be checked. The BPS display window will display the current power output to the ITAS (Figure 2-50, page 2-38).

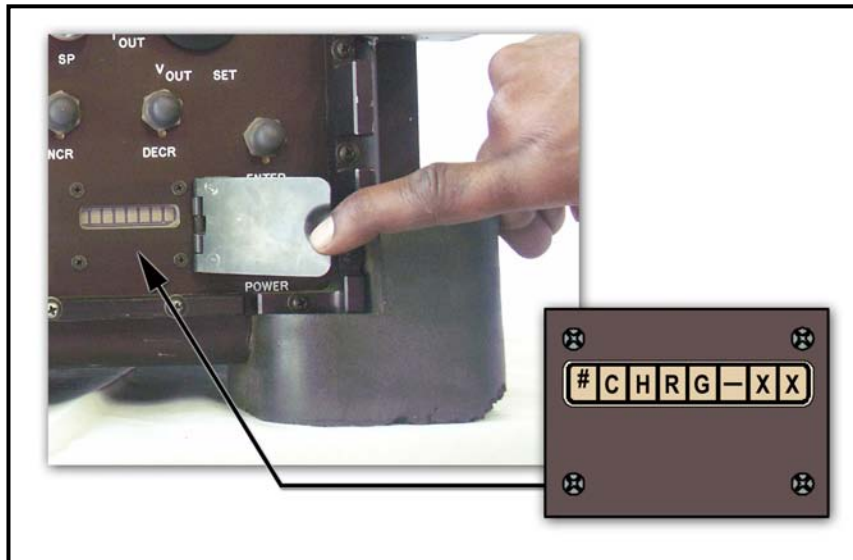
**NOTE:**  $I_{OUT}$  is a maintenance function check.



**Figure 2-50. BPS displays current power output.**

(c) *CHG CYCLES*. Only battery maintenance personnel use this setting. When the function switch is placed in the CHG CYCLES position, the number of times the BPS has been charged using AC power can be checked. The BPS display window will display the number of times (Figure 2-51).

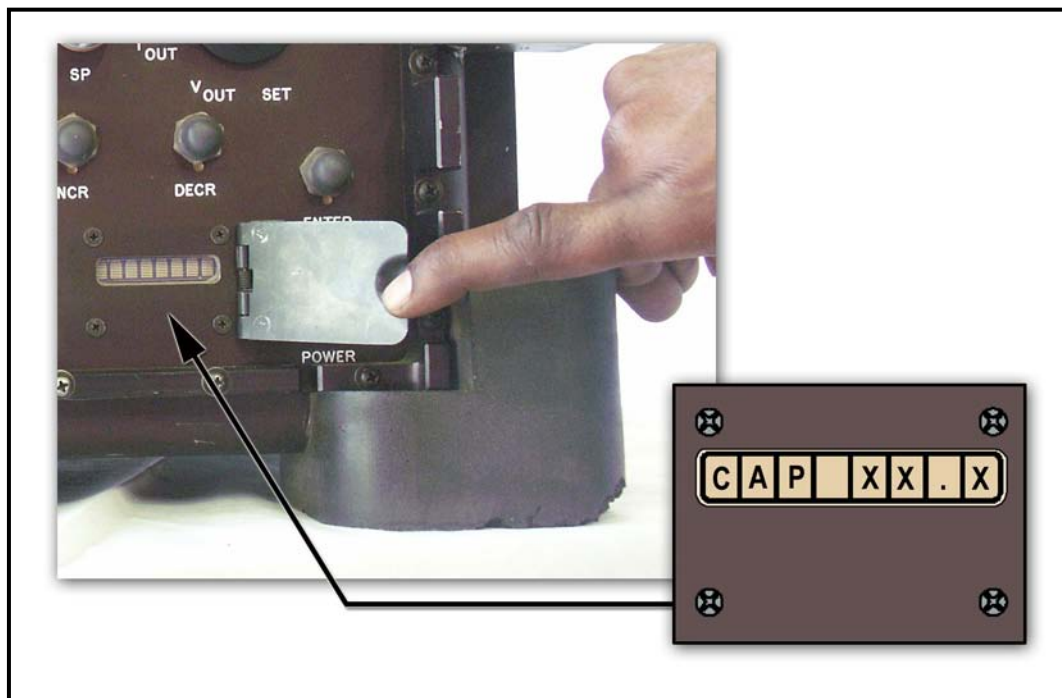
- The count increases every time the recharge cable is plugged in.
- Replacing the BPS battery resets this number to zero automatically.



**Figure 2-51. BPS displays number of charges.**

(d) *BATT CAP*. When the function switch is placed in the BATT CAP position, the capacity of the BPS INTERNAL batteries can be checked. The BPS display window will display the current internal batteries ampere (amp) hours (Figure 2-52). Every 10 amps is one hour of operating time. When 100 is shown, the batteries have the capability to deliver 10 amps for 10 hours.

- The higher the number, the longer the battery should last under normal operation.
- Older batteries will achieve less than 80 amp hours capacity when they are fully charged
- When a full 20-hour charge only achieves a capacity of 40 amp hours or less, turn the BPS in for maintenance.



**Figure 2-52. BPS displays current internal batteries ampere hours.**

(e) *ACT DATE*. When the function switch is placed in the ACT DATE position, the activation date of the BPS can be checked (Figure 2-53, page 2-40). The BPS display window will display the date the BPS batteries were installed. An eight-digit letter code is used:

- First and second digits = activation date.
- Third and fourth digits = month of the year.
- Fifth and sixth digits = days of the month.
- Seventh and eighth digits = year installed.

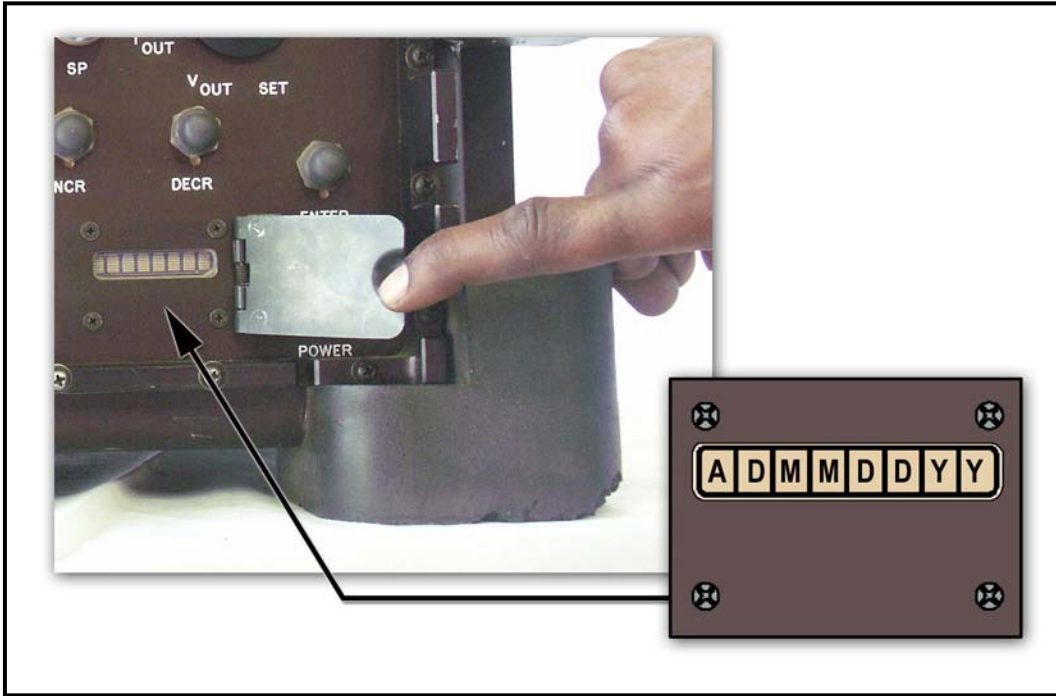


Figure 2-53. BPS displays date batteries were installed.

(f) *Date*. This is used by maintenance personnel only (Figure 2-54).

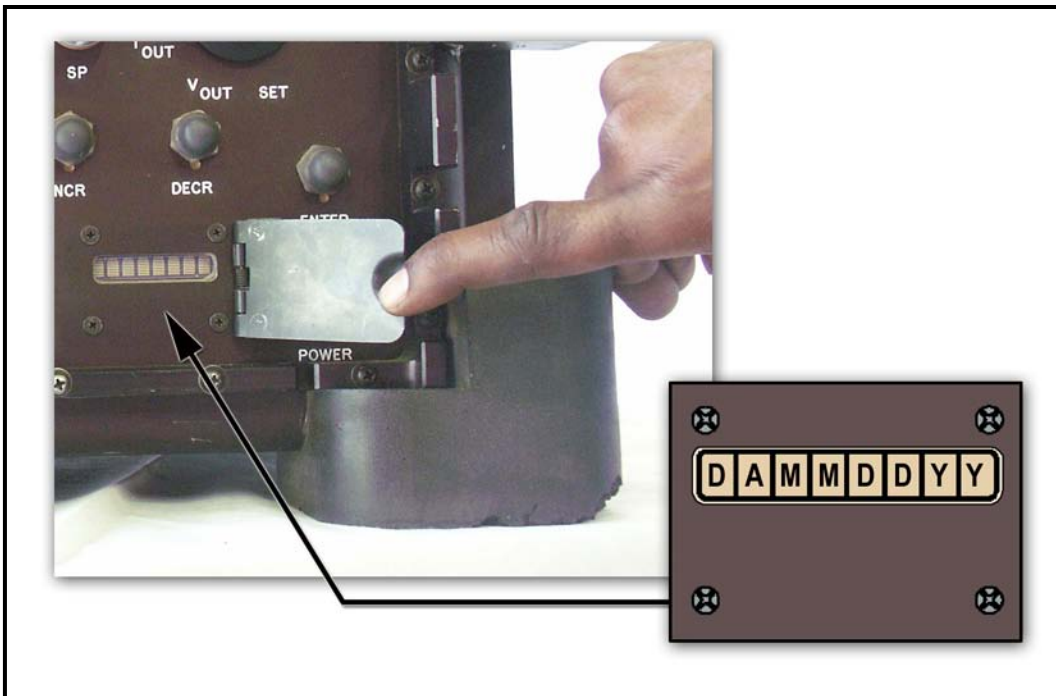


Figure 2-54. BPS displays date.

(g) *BIT*. When the function switch is placed in the BIT position, internal BPS software checks can be conducted. The BPS display window will display the results of any internal BPS BITs (Figure 2-55).

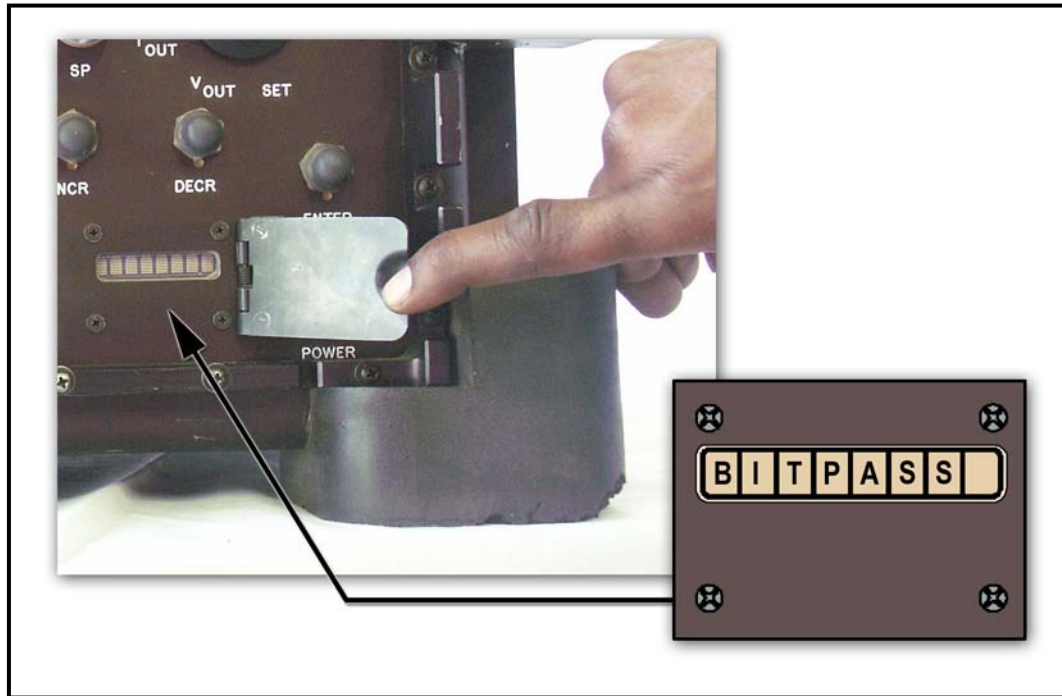


Figure 2-55. BPS displays BIT results.

(h) *SET*. This is used by maintenance personnel only (Figure 2-56).

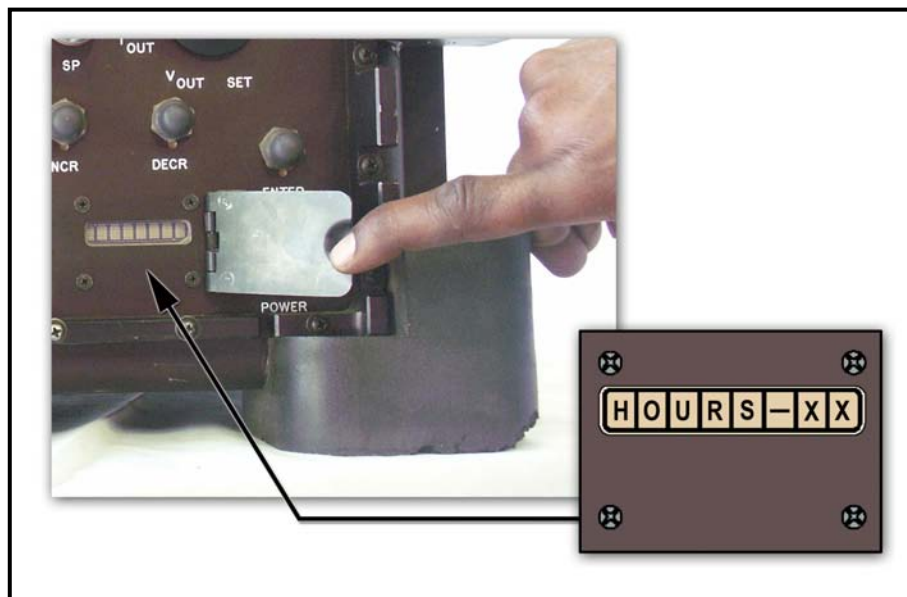
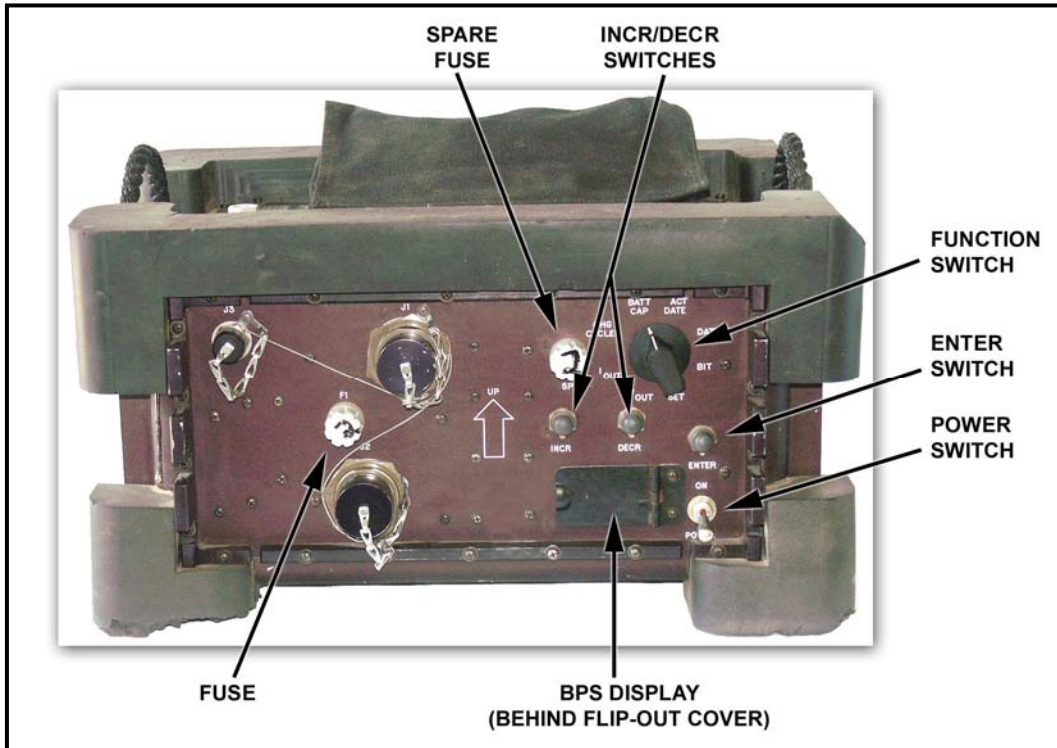


Figure 2-56. BPS displays SET.

c. **INCR and DECR Switches.** The increase (INCR) and decrease (DECR) push-button switches are located just below and to the left of the function switch (Figure 2-57). The two switches provide the capability to change three functions on the BPS:

- Setting the date information (minutes, hours, days, month, year).
- Selecting the BPS BIT fault codes for maintenance.
- Setting the battery activation date.



**Figure 2-57. BPS controls and indicators.**

d. **ENTER Switch.** The ENTER switch is a push button located on the right side of the BPS front panel (Figure 2-57). When the function switch is placed in the BIT position, pushing ENTER will initiate the BPS BIT. Results of this test are shown on the BPS display indicator as fault codes for maintenance personnel.

e. **POWER Switch.** The power switch, located in the lower right corner of the BPS, turns on the BPS (Figure 2-57). It is the first switch turned on in the ITAS power-up procedures.

f. **Fuse.** The fuse protects the BPS from damage caused by a short in the cables or ITAS components (Figure 2-57).

g. **Spare Fuse.** The spare fuse can be exchanged with a faulty fuse to restore operation (Figure 2-57).

---

## CHAPTER 3

# MOUNTED AND DISMOUNTED OPERATIONS

*The M41 ITAS is primarily a mounted system that utilizes the M1121 HMMWV as the carrier vehicle. Current doctrine demands a highly mobile antiarmor weapons system that incorporates the latest technology for the modern battlefield. The M1121 HMMWV is a one-vehicle (1 1/4-ton truck) combat system that is air transportable, versatile, maintainable, and survivable (Figure 3-1, page 3-2). Its 16-inch ground clearance, four-wheel independent suspension, steep approach and departure angles of 60-percent grade, side slope of 40 percent, and 30-inch water-fording capability (without fording kit, 60-inch with kit) provides the off-road mobility and speed needed in combat. The vehicle carries one complete launcher system, seven encased missiles, and a three-man crew. The tactical or training situation may demand that the crew dismount the carrier and employ the ITAS in the dismounted or tripod configuration. This chapter discusses the operation of the ITAS while mounted on the M1121 HMMWV and dismounted in tripod configuration.*

### Section I. MOUNTED OPERATIONS

Advancing technology demands mobility on the battlefield, and the mounted M41 ITAS provides this capability. The mounted configuration is the primary method of employment for the M41 ITAS.

#### 3-1. PREVENTIVE MAINTENANCE CHECKS AND SERVICES

Always conduct preventive maintenance checks and services (PMCS) using the technical manual (TM 9-1425-923-12). These checks and adjustments are normally made immediately after complying with before-operations PMCS or after assembling the M41 ITAS, either in the mounted or dismounted configuration. Conduct a system checkout to ensure that the system is working properly before engaging targets, if time permits. System checkout consists of PBIT, IBIT, boresight, GRIPS test, and operator's checks. (See TM 9-1425-923-12 for complete details.)

#### 3-2. MOUNT THE ITAS ON THE M1121 HMMWV

The three-man crew prepares the M1121 for ITAS firing as follows:

- a. The gunner, driver-loader, and squad leader release the latches securing the hatch cover (Figure 3-1, page 3-2).



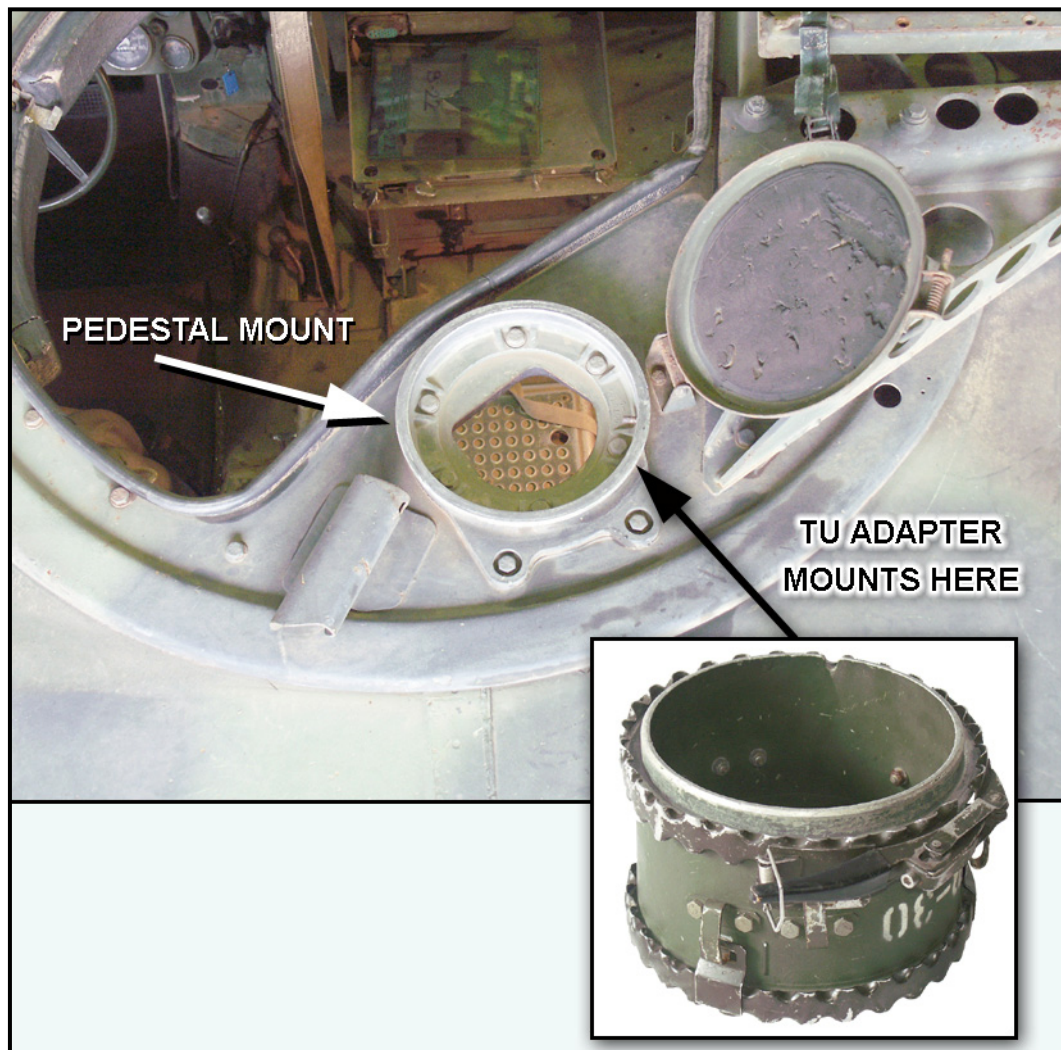
**Figure 3-1. Hatch cover latches.**

b. From the loader's position in the cargo hatch, the driver-loader stows the BPS and secures it with straps, and connects the J1 and J2 connectors. He turns the BPS power switch to the ON position, turns the function switch to BIT, and checks the results of the BPS PBIT. He also checks battery capacity and voltage (TM 9-1425-923-12).

c. The squad leader places the tripod in the stow position on the vehicle. He fits the tripod body over the mounting bracket and secures the tripod with a coupling clamp. He straps the tripod in place using the retention straps.

d. The gunner attaches the TU adapter to the pedestal mount (Figure 3-2).





**Figure 3-2. TU adapter attaches to pedestal mount.**

- d. The driver passes the TU up through the weapon station to the gunner.

**CAUTIONS**

1. Do not lift the TU by the handgrips. The weight of the TU will cause them to break and the equipment will be inoperable.
2. Do not set the TU on the coil cable. Doing so may damage the coil cable connector.

(1) The gunner places the TU next to the pedestal mount. He passes the coil cable down through the hole in the pedestal mount (Figure 3-3). He mounts the TU on the TU adapter and secures it with the coupling clamp.



**Figure 3-3. Coil cable passes through pedestal mount.**

(2) The driver passes the launch tube to the gunner (Figure 3-4).



**Figure 3-4. Launch tube passed to gunner.**

- e. The gunner mounts the launch tube into position, placing the launch tube latch into the launch tube catch, and presses down until locked.
- f. The gunner removes the TAS mount connector cover.

**CAUTION**

Ensure that the electrical connector on the TAS mount is free of dirt or foreign material fully seated before installing the ITAS on the TU. Failure to do so could cause damage to the connector pins.

- g. The driver passes the TAS to the gunner.
- h. The gunner places the TAS onto the TAS mount with the window facing forward (Figure 3-5). He rotates the TAS until the index lug slot fits over the index lug on the TAS mount and locks the TAS into position with the coupling clamp.



**Figure 3-5. TAS being placed on TAS mount, window forward.**

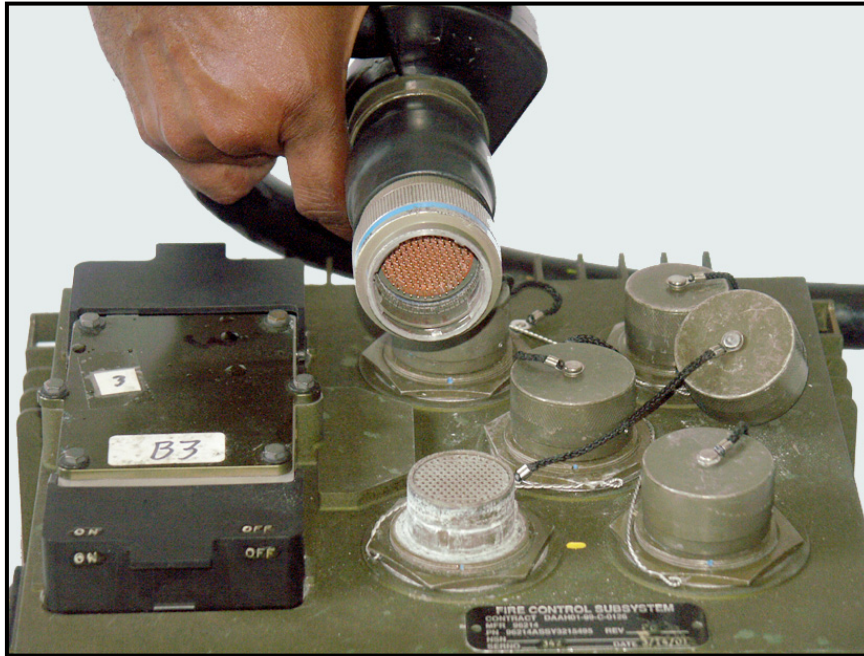
- i. The driver passes the FCS to the gunner on the left side of the HMMWV. The gunner mounts the FCS in the FCS mounting bracket with the power switch facing the weapon station opening. He secures the FCS with the four straps attached to the FCS mounting bracket.

- j. The gunner connects the coil cable to the FCS.
- (1) He removes the J1 and J2 connector covers on the FCS.
  - (2) He connects the coil cable, with the pin-saver adapter attached, to the FCS J2 connector (Figure 3-6).
  - (3) He connects HMMWV interface cable (HIC) to the FCS J1 connector.

**CAUTION**

Ensure that no dirt or foreign material is in the end of the coil cable connector. Failure to do so could cause damage to the connector pins.

**NOTE:** The coil cable can be connected without the pin saver adapter in a combat situation only.



**Figure 3-6. Coil cable connects to FCS J2 connector.**

### 3-3. MOUNTED FIRING POSITIONS

When the ITAS is assembled for M1121, the vehicle must be level for effective operation of the weapon. If the vehicle is not level, lateral (azimuth) movement of the TU produces a change in the elevation angle of the launch tube; therefore, acquiring and tracking the target may be difficult. An unlevelled vehicle can cause an electronic control error during the final tracking operation (while the command-link wire is guiding the missile to its target). When the vehicle is properly positioned, the leveling bubble in each level will be between the marks on the level indicators. The ITAS is not fired from a position where the TU has a lateral cant of more than 10 degrees. The ideal firing position is as level as

possible. However, the missile can be fired from a position where the tripod is canted as much as 30 degrees directly downhill or uphill. After the site is selected and the weapon emplaced, the squad leader and gunner make a range card for the position. (For detailed information on making a range card, see Appendix D.)

**NOTE:** Range card preparation applies to mounted and dismounted operations.

### 3-4. PREPARATION OF MISSILE FOR FIRING

The TOW missile requires complete attention to detail when preparing it for firing missions. Missile identification, inspection, and correct handling procedures eliminate safety hazards to personnel and equipment. (See TM 9-1425-923-12 for complete details.)

### 3-5. LOADING, ARMING, AND UNLOADING

The procedures for loading, arming, and unloading the M41 while mounted on the M1121 HMMWV are as follows:

a. **Load.** The forward handling ring, preformed packing, electrical connector cap, and quick-release clamp are saved in case the missile is not fired. If missile diaphragms are damaged while loading, the missile can still be fired. The following procedures are performed to load the M41 ITAS while mounted on the M1121 HMMWV.

(1) Using the azimuth and elevation locks on the TU, the gunner ensures that the system is locked in the 8-degree down position. The gunner locks the system down by pulling the elevation locking handle towards the rear of the system and pushes the azimuth locking handle towards the left side of the system.

(2) The gunner opens the bridge clamp to load the missile.

(a) Hold encased missile with aft end raised at 45 degrees with the electrical connector facing up. Insert indexing lugs on encased missile into missile guide slots on launch tube.

(b) Slide encased missile forward into launch tube until indexing lugs are firmly in place.

(c) Lower aft end of encased missile ensuring it is fully seated in TU.

(d) Lock bridge clamp by pushing down on a bridge clamp and pulling bridge clamp handle down to lock encased missile in launch tube.

b. **Arm.** The following procedures are performed to arm the M41 ITAS while mounted on the M1121 HMMWV.

#### **WARNING**

**Cargo shell door must be closed and securely latched at both ends before firing the missile. Firing the missile with the door unsecured will cause injury to personnel and damage to equipment.**

(1) The driver-loader closes the cargo shell door and ensures that it is securely latched.

**DANGER**  
**SERIOUS INJURY TO PERSONNEL COULD RESULT IF THE CREWMEMBERS ARE IN THE FIRING DANGER ZONES (BACKBLAST AREA) WHEN THE MISSILE IS LAUNCHED. MAKE SURE THE CREW IS OUT OF THE FIRING DANGER ZONES BEFORE PULLING THE FIRE TRIGGER.**

(2) The gunner checks the backblast area; announces, “BACKBLAST AREA CLEAR,” and then arms the missile by raising the arming lever.

c. **Unload.** After the missile has impacted, the gunner locks the TU in the 8-degree down position.

**NOTE.** If a missile is not fired after being prepared for firing, it must be immediately tagged to show the time, date, and using unit. If the missile is not used within 90 days of initial preparation, it must be turned in to the ammunition supply point.

(1) Raise the bridge clamp handle and open the bridge clamp. (This action will cut the command-link wires and turn off the xenon tracker in the TAS.)

(2) Remove empty missile container.

(a) Lift the aft end of the launch container and remove the launch container from the launch tube.

(b) Dispose of empty launch container in accordance with unit SOP.

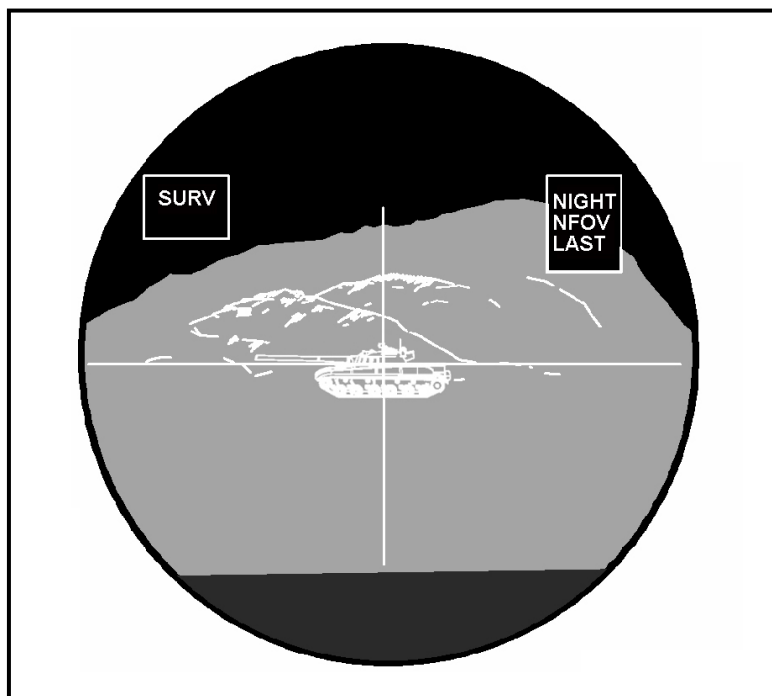
### **3-6. TARGET ENGAGEMENT**

The crewmembers perform the following target engagement procedures.

a. When the squad leader issues the fire command, the gunner releases the azimuth and elevation locks on the TU, if not already released.

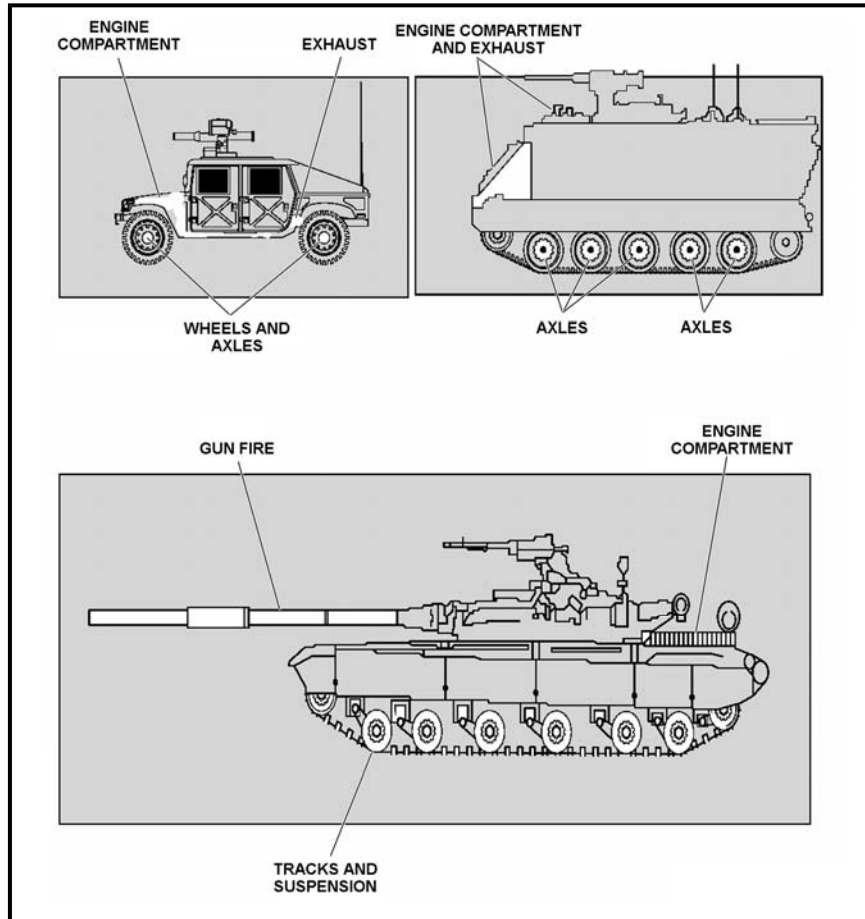
**CAUTION**  
If crewmembers other than the gunner are in, or leaning on, the M1121 HMMWV, they must be completely still while the gunner is tracking. Even small movements can cause the vehicle to move and adversely affect the gunner’s aim.

- b. The gunner acquires and begins to track the target.
- (1) If the target cannot be acquired in the sight, he announces, "Lost." He presses SGT SEL switch to activate the NVS WFOV and scans the sector of fire for targets. After detecting a target, he presses the FOV switch to select NFOV (Figure 3-7).
  - (2) When the target has been acquired, he identifies it as friendly or enemy.
  - (3) If the target cannot be identified, he announces, "Cannot identify."
  - (4) If the target is identified as enemy, he proceeds with a manual or tracker engagement.



**Figure 3-7. NVS NFOV selected.**

- c. During a tracker engagement, the gunner uses the aided target tracker. Using the track gates will keep the missile on line with the target even if the gunner drifts off the target for a short period of time and reacquires the target before impact.
- d. The gunner determines if the target is a wheeled or track vehicle. If it is a track vehicle, he determines if it is an APC or a tank (Figure 3-8, page 3-10).



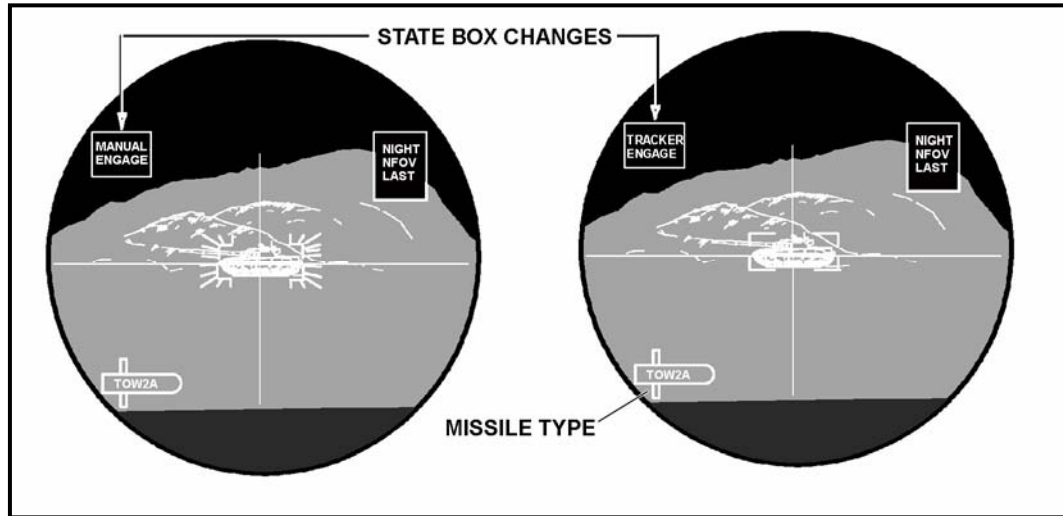
**Figure 3-8. Determine type of target.**

e. The gunner determines target engageability (NFOV) using passive ranging or LRF.

**NOTE:** The gunner must use active ranging to determine the actual range to targets other than tanks beyond ranges of 3,500 meters. Passive ranging is based on main battle tank (MBT) at 1,500 meters.

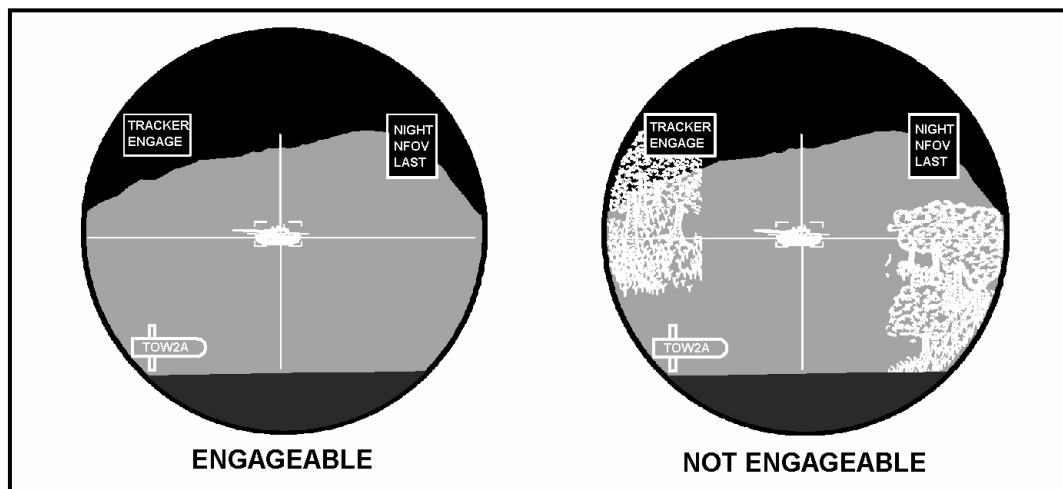
(1) If in range, the gunner arms the missile. The mode box will change from SURV to MANUAL ENGAGE and the missile type symbol will come up. He locks on the target (Figure 3-9), by pressing the TRK GATE switch to activate the track gates, and uses the GATE ADJ switch to adjust the track gates around the target. He presses the TRK GATE switch again to lock the track gates on the target.





**Figure 3-9. Target lock-on.**

(2) If the target is moving, the gunner determines the exposure time (NFOV) (Figure 3-10).

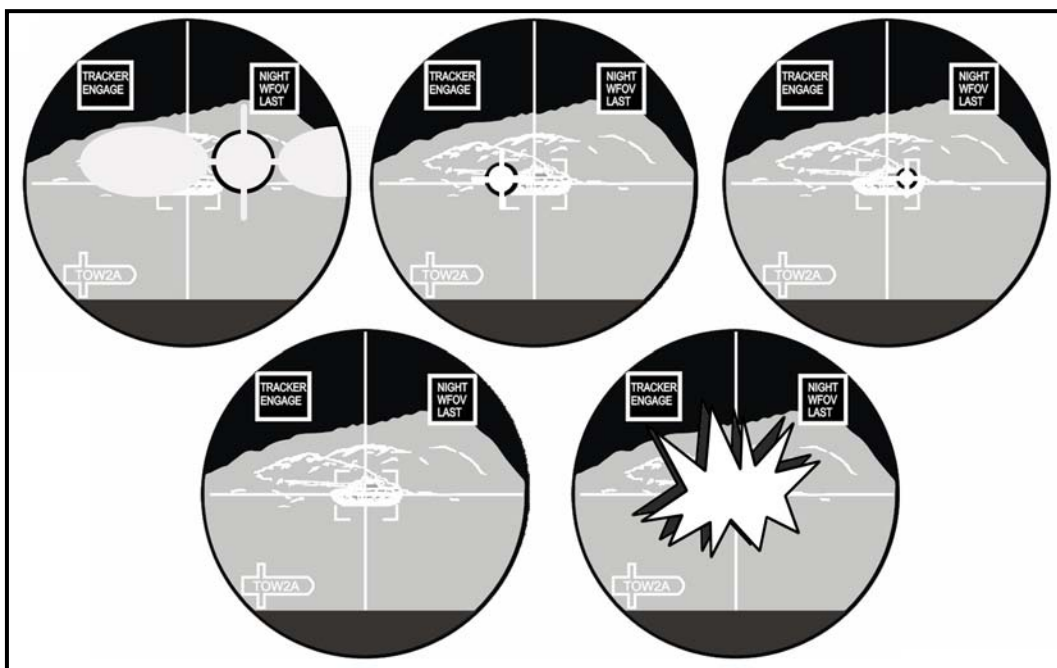


**Figure 3-10. Target exposure time.**

- f. The gunner launches the missile.
- (1) He checks the crosshairs and track gates. The crosshairs must be centered on the target, and the track gates must be around the target and solid (not flashing).
  - (2) The gunner takes a deep breath and lets part of it out. Proper breath control is especially important during the first and last 400 meters of missile flight. Improper breathing will cause poor tracking.
  - (3) The gunner presses the trigger. A 1.5-second delay will occur before the missile is launched. This delayed firing of the launch motor can cause flinching or jerking of the handgrips if the gunner is not prepared for it.

- NOTE:** The gunner should be prepared for two noises after pressing the trigger:
1. The first noise is the gyro being activated. This is not loud, but it may cause the gunner to think a hangfire has occurred and he may not be prepared for the next noise.
  2. The second noise is the launch motor firing. This is a loud noise similar to the AT4 firing and may cause the gunner to flinch.

(4) When the missile appears in the TAS display (Figure 3-11), the gunner ignores it. **He never tries to guide the missile.** If he is distracted, his tracking becomes poor and his chances of hitting the target are reduced.



**Figure 3-11. Missile impact.**

### 3-7. TROUBLESHOOTING A TRACKER ENGAGEMENT

Use the following procedures to troubleshoot a tracker engagement.

a. **Tracker Will Not Lock on Target.** Two things happen to indicate that a good lock has occurred. The track gates become solid, and TRACKER ENGAGE appears in the mode box of the TAS display.

(1) Conditions that could cause the ITAS not to lock on the target are:

- Poor range focus. A poor range focus will make it hard for the tracker to identify the target.
- The target is in an area of high IR clutter. The tracker cannot distinguish between the target and the background clutter.
- Low Delta-Ts/IR crossover occurring.

(2) Various corrective actions can be taken.

(a) In the case of poor range focus, the gunner must focus the NVS and readjust the track gates to place as much of the center of the target inside the track gates as possible

and still have the track gates touching the edges of the target. If the tracker still does not lock onto the target, the gunner readjusts the track gates slightly smaller on the center of the target.

(b) In the case of high IR clutter, the gunner can decrease the size of the track gates and attempt to lock on, or wait until the target leaves the area of high IR clutter.

(c) In the case of low Delta-Ts, the gunner must wait until the Delta-Ts in the target scene change. This occurs if the target scene warms due to solar heating, if the target cools from a lack of solar heat, or if the target warms itself from movement and or running the engine.

(d) If NONE of the above actions correct the problem, the gunner reverts to a manual engagement.

**b. Track Gates are Too Large.** When the track gates are set too large (A, Figure 3-12, page 3-14), they include part of the surrounding terrain, which is undesirable because the tracker may lose the target during missile flight and impact on the “ground” part of the target instead of the “vehicle” part of the target. Various corrective actions can be taken.

(1) The gunner breaks the lock, adjusts the track gates so they are smaller, and relocks onto the target.

(2) The gunner may also move the position of the target within the track gates and attempt lock-on again.

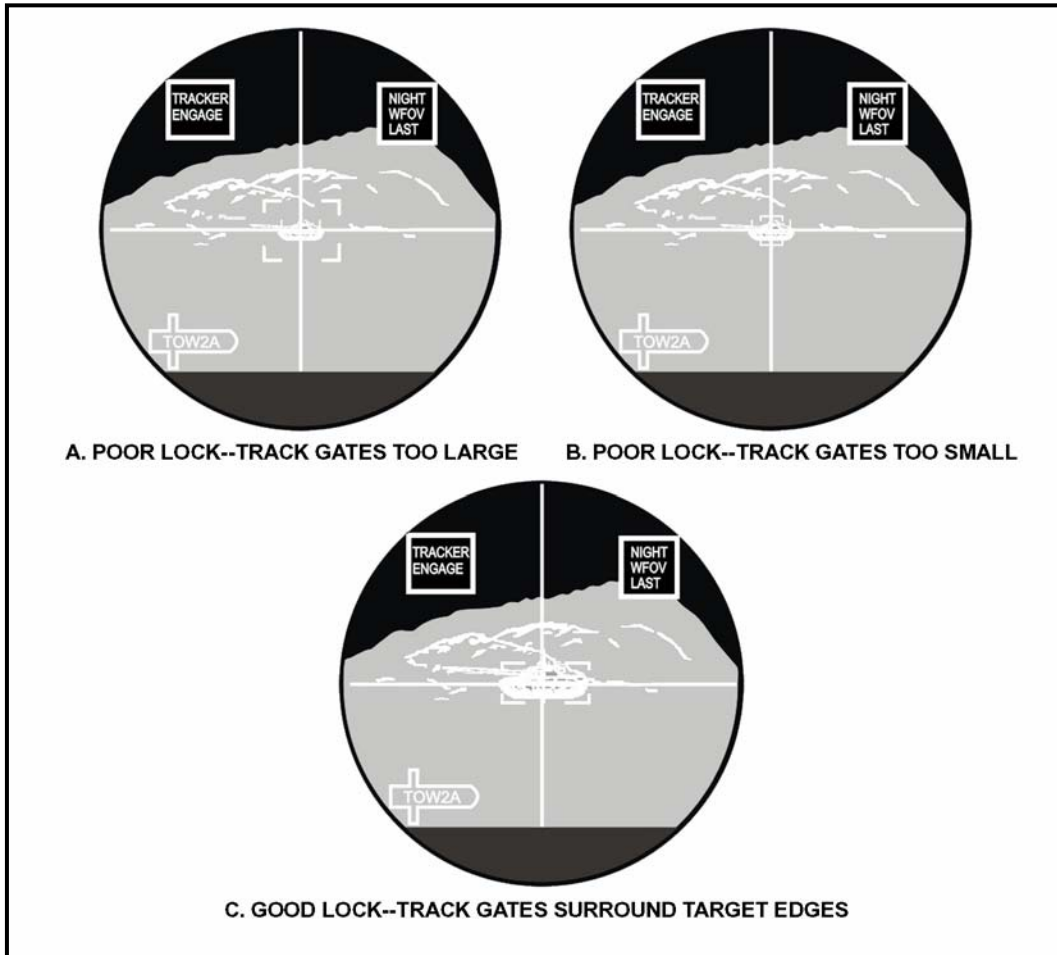
(3) The gunner performs these actions until he achieves a good lock quality (C, Figure 3-12, page 3-14).

**c. Track Gates are Too Small.** When the track gates are set too small, they only surround a portion of the target instead of the complete target (B, Figure 3-12, page 3-14). Various corrective actions can be taken.

(1) The gunner breaks the lock, adjusts the track gates so they are larger, and relocks onto the target.

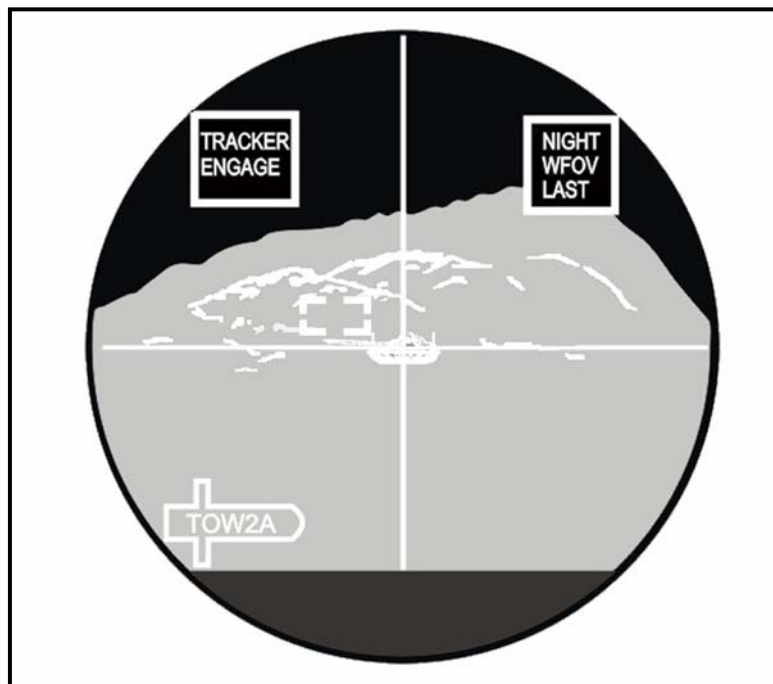
(2) The gunner may also move the position of the target within the track gates and attempt lock-on again.

(3) The gunner performs these actions until he achieves a good lock quality (C, Figure 3-12, page 3-14).



**Figure 3-12. Proper track gate size.**

d. **Track Gates are Unstable.** The tracker does not have a good lock on the target if the track gates seem to jump from one position to another at lock-on (unstable), which is caused by some feature (normally IR clutter) in the track gate that the gunner cannot see (Figure 3-13). However, the tracker **can** detect the feature and is trying to incorporate it into the lock-on solution. The gunner breaks the lock-on, decreases the size of the track gates, and attempts to lock onto the target again.



**Figure 3-13. Unstable track gates at lock-on.**

e. **Moving Targets.** If the target is moving, the gunner must slew the TU to keep the crosshairs centered on the visible mass. If the target is moving slowly, the gunner adjusts the track gates to the size of the target, no matter which direction the target is moving. However, if the target is moving quickly, the gunner must consider the direction of movement and how the movement affects the relative size of the target.

(1) **Tanks.** To ensure a good lock-on, the gunner concentrates on keeping the target's center of mass—the tank's body and turret but not the gun barrel—centered in the track gates and adjusts the track gates as close to the tank edges as possible.

(2) **Target Without Turrets.** The track gate adjustment for targets without turrets is the same as that for tanks except there is no turret to be included when adjusting the track gates.

(3) **Low Target Definition.** Conditions that can cause low target definition include low Delta-Ts (difference in temperature), IR clutter, and partial masking of selected target.

f. **Tracker Break-lock.** A break-lock occurs after lock-on when the track gates appear to jump from one point to another instead of moving smoothly. A break-lock situation can occur either before or after missile launch.

(1) While the break-lock situations before launch and after launch are the same, the corrective actions are different.

(a) Corrective actions for a tracker break-lock before launch are:

- The gunner should push the TRK GATE switch while the crosshairs are in the track gates to remove the track gates and attempt to relock on the target.
- If the gunner cannot lock on the target, he should attempt a manual engagement.

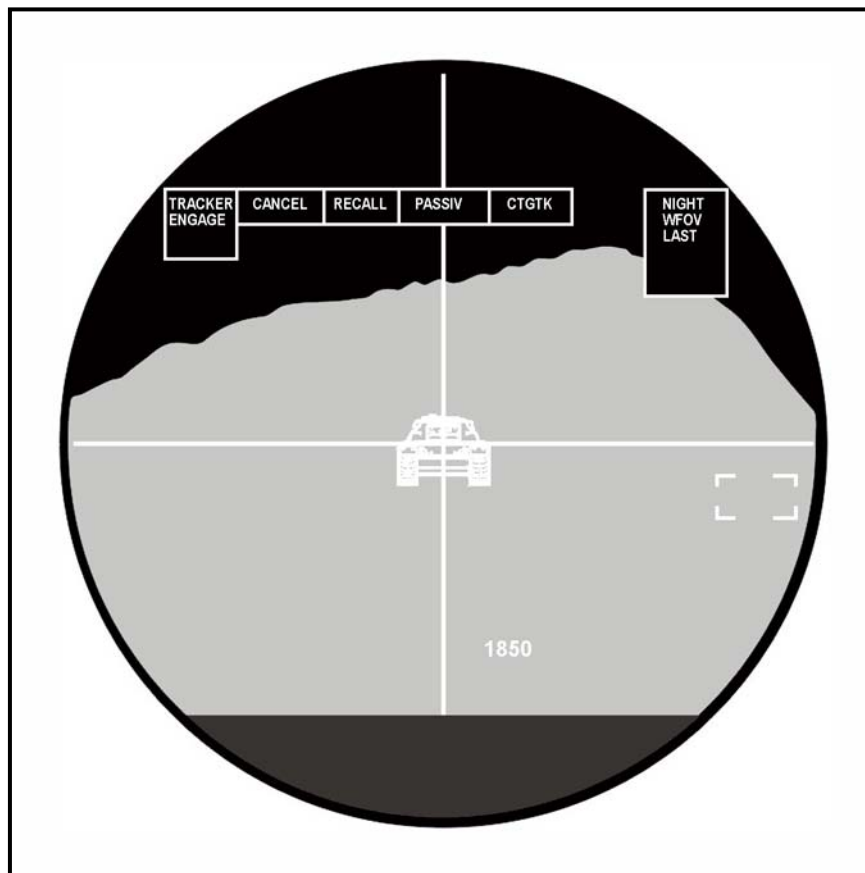
(b) Corrective actions for a tracker break-lock after launch are:

- The gunner keeps the crosshairs on the target. He does not attempt to relock on the target. The tracker will attempt to find the target at the crosshairs.
- After four seconds, if the tracker cannot relock on the target, the FCS will default to manual engage and the missile will be guided to the crosshairs.

(2) To cancel target lock-on, the gunner uses either of two methods.

(a) TRK GATE switch method—the gunner presses the TRK GATE switch again while the crosshairs are inside the track gates and the track gates will disappear.

(b) Menu method (Figure 3-14)—the gunner selects CTGTK (Cancel TarGet Tracker) from the menu to delete the track gates. If two track gates are present, CTGTK cancels the track gates farthest from the crosshairs. The steps must be repeated to remove the second set of crosshairs, if necessary.



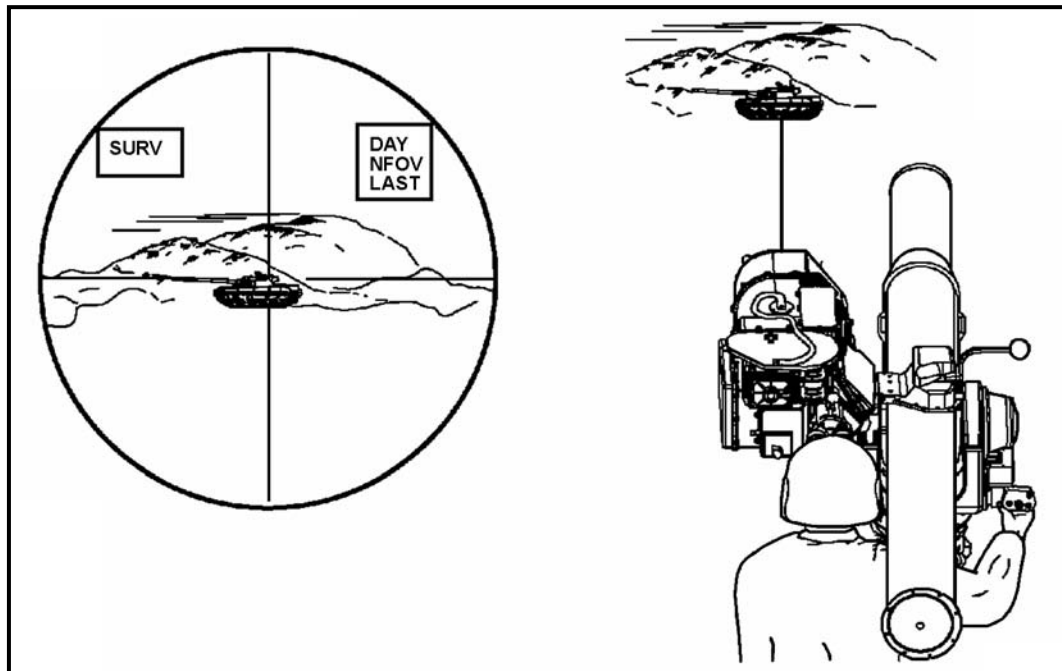
**Figure 3-14. Passive ranging/cancel target tracker menu**

**NOTE:** Manual target engagements can be achieved using either the daysight or the NVS.

### 3-8. MANUAL ENGAGEMENT

The following procedures detail using the daysight. To use the NVS, just press the sight select switch to activate it.

- a. Place the ITAS into operation.
  - (1) Assemble the system in the tripod- or HMMWV-mounted configuration.
  - (2) Perform system checkout procedures.
- b. Load an encased missile.
- c. Acquire target (WFOV) using the daysight.
  - (1) Scan sector of fire for targets.
  - (2) After detecting target, press FOV switch and select NFOV (Figure 3-15).



**Figure 3-15. Daysight NFOV selected.**

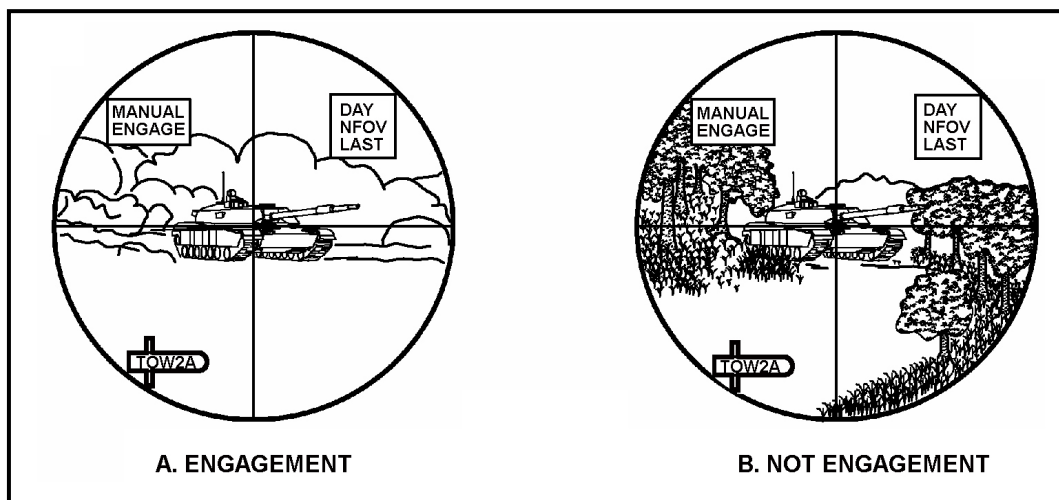
- d. The gunner determines if the target is a wheeled or track vehicle; if it is a track vehicle, he determines if it is an APC or a tank
- e. The gunner determines target engageability (NFOV) using the daysight.
  - (1) Use LRF or passive ranging.
  - (2) Arm the missile if target is engageable.

**NOTE:** When the target is in range, the gunner must determine exposure time of the target (moving) to make sure that it will not reach cover before missile impact.

(3) If moving, determine exposure time (NFOV). Exposure time requirements do not apply for stationary targets, only if the target starts to move before missile launch. The gunner can determine the exposure time for a moving target by using the crosshairs. The gunner first places the crosshairs on center of visible mass.

(a) If the area between the vertical crosshair and the edge of the field of view in the direction of travel is clear of obstructions, the target is engageable (A, Figure 3-16).

(b) If obstructions appear between the vertical crosshair and the edge of the field of view, the target is not engageable. The target will reach cover before the missile reaches the target (B, Figure 3-16).



**Figure 3-16. Target exposure.**

e. The gunner fires the missile.

(1) He takes a deep breath and lets part of it out. Proper breath control is particularly important during the first and last 400 meters of missile flight. Improper breathing will cause poor tracking.

(2) The gunner presses the trigger. A 1.5-second delay occurs before the missile is launched. This delayed firing of the launch motor can cause him to flinch or jerk the control handgrips if he is not prepared for it.

**NOTES:** The gunner should be prepared for two noises after pressing the trigger:

1. The first noise is the gyro being activated. It is not loud, but it may cause the gunner to think a hangfire has occurred and he may not be prepared for the next noise.
2. The second noise is the launch motor firing. This is a loud noise similar to the AT4 firing and may cause the gunner to flinch.

(3) When the missile appears in the sight picture (Figure 3-17), the gunner ignores it. **He never tries to guide the missile.** If he is distracted, his tracking becomes poor and his chances of hitting the target are reduced. The gunner keeps the crosshairs on the center of visible mass of the target until impact.



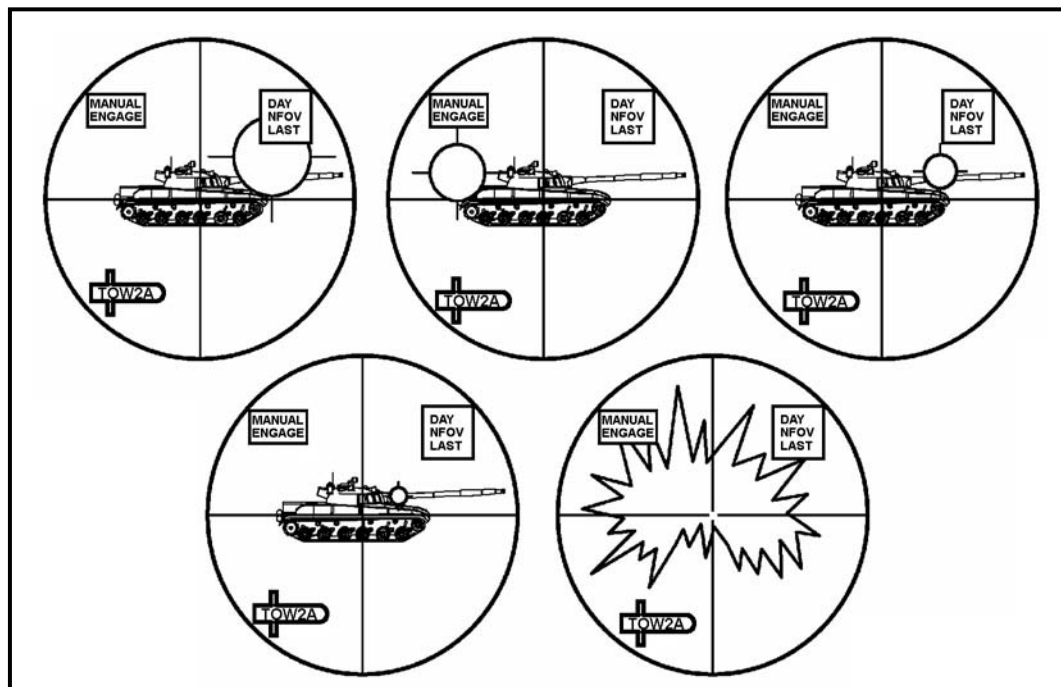


Figure 3-17. Missile impact.

### 3-9. MOUNT THE ITAS FROM THE DISMOUNTED (TRIPOD) CONFIGURATION

The following actions occur at the same time when the squad leader commands, CEASE TRACKING, OUT OF ACTION.

a. **Firing Position Actions.** The following actions take place at the firing position before returning to the vehicle.

(1) **Squad Leader's Actions.** The squad leader—

(a) Removes the launch tube and places it on the ground.

(b) Folds the tripod legs and commands, MOVE OUT. (The squad leader remains at the firing position until the driver-loader returns and all equipment is en route to the vehicle.)

(c) Carries the tripod and launch tube back to the vehicle. Places the launch tube on the ground on the driver's side of the vehicle and the rest of the equipment on the ground behind the vehicle.

(2) **Gunner's Actions.** The gunner—

(a) Powers down the system and disconnects and stows the coil cable and interface cable.

(b) Replaces the TAS lens cover and removes the TAS from the TU

(c) Picks up the FCS; carries the TAS and the FCS to the vehicle.

(d) Places the TAS and the FCS on the ground and enters the gunner's station.

(3) **Driver-Loader's Actions.** The driver-loader—

(a) Removes the encased missile (or empty launch container if the missile was fired).

(b) Removes the TU from the tripod, carries it to the vehicle, and hands it to the gunner when the gunner reenters the gunner's station.

(c) Returns to the firing position to get the BPS. Carries the BPS to the vehicle where the squad leader straps it in the BPS mount.

(d) Returns to the firing position to get the encased missile (if a missile was not fired) and carries it to the vehicle. Hands the missile to the gunner.

b. **Remount Actions.** The following actions are performed to remount the vehicle.

(1) **Squad Leader's Actions.** The squad leader—

(a) Hands the TAS to the gunner and stows the tripod on the vehicle. Closes the tailgate and cargo shell door.

(c) Assists other crewmembers, as needed.

(2) **Gunner's Actions.** The gunner—

(a) Receives the TU from the driver-loader, installs it on the TU adapter, and secures it with the top coupling clamp.

(b) Installs the FCS in the FCS tray and secures it with the straps, connects the coil cable to the FCS J2, and takes the HIC from the squad leader and connects it to the FCS J1 connector.

(c) Installs the TAS on the TAS mount of the TU.

(d) If time permits, conducts the IBIT, boresight, and GRIPS test.

(3) **Driver-Loader's Actions.** The driver-loader—

(a) Hands the launch tube up to the gunner.

(b) Enters the right rear door, stows the BPS, and connects the vehicle power cable and HIC cable to the J1 and J2 connectors on the BPS.

(c) Hands the HIC and the coil cable to the gunner.

(d) Moves into the cargo area and places the unfired missiles in the missile rack (if necessary).

**NOTE:** If a missile was fired in combat, the empty launch container is destroyed IAW unit SOP. If a missile was fired in training, the empty launch container is turned in to the ASP.

### 3-10. STOW ITAS ON THE M1121 FROM DISMOUNTED POSITION

Crewmembers use the following procedures to stow the ITAS on the M1121 HMMWV.

a. Prepare ITAS for stowage. The gunner—

(1) Locks the ITAS in the 8-degree down position.

<p style="text-align: center;"><b>CAUTION</b></p>
---

<p>Failure to turn power off on TAS, FCS, and BPS may result in damage to components when electrical connectors are removed.</p>
--

(2) Powers down the ITAS by turning off the following power switches in sequence: TAS, FCS, and BPS.

(3) Unloads the encased missile, if one is loaded.

- (4) Disconnects the following cable connectors.
  - (a) The coil cable from the FCS J2 connector. Replaces the connector cover on the FCS J2 connector.
  - (b) The interface cable from the FCS and BPS. Replaces the connector cover on the FCS and BPS. Stows the interface cable in the FCS stow bag.
    - b. Remove and stow the launch tube in the HMMWV. The squad leader—
      - (1) Releases the launch tube latch on the TU.
      - (2) Raises the launch tube high enough to clear the launch tube brackets on the TU and removes the launch tube.
      - (3) Carries the launch tube to the HMMWV.

**WARNING**

**Before opening one end of the cargo shell door, ensure the opposite end is securely closed. Failure to do so will cause both ends to open at the same time, causing injury to personnel or damage to equipment.**

- (4) Opens the cargo shell door on the rear of the vehicle and stows the launch tube on the cargo shell door.
  - (a) Places the launch tube catch mating hole over the launch tube mounting bracket guide pin (Figure 3-18).

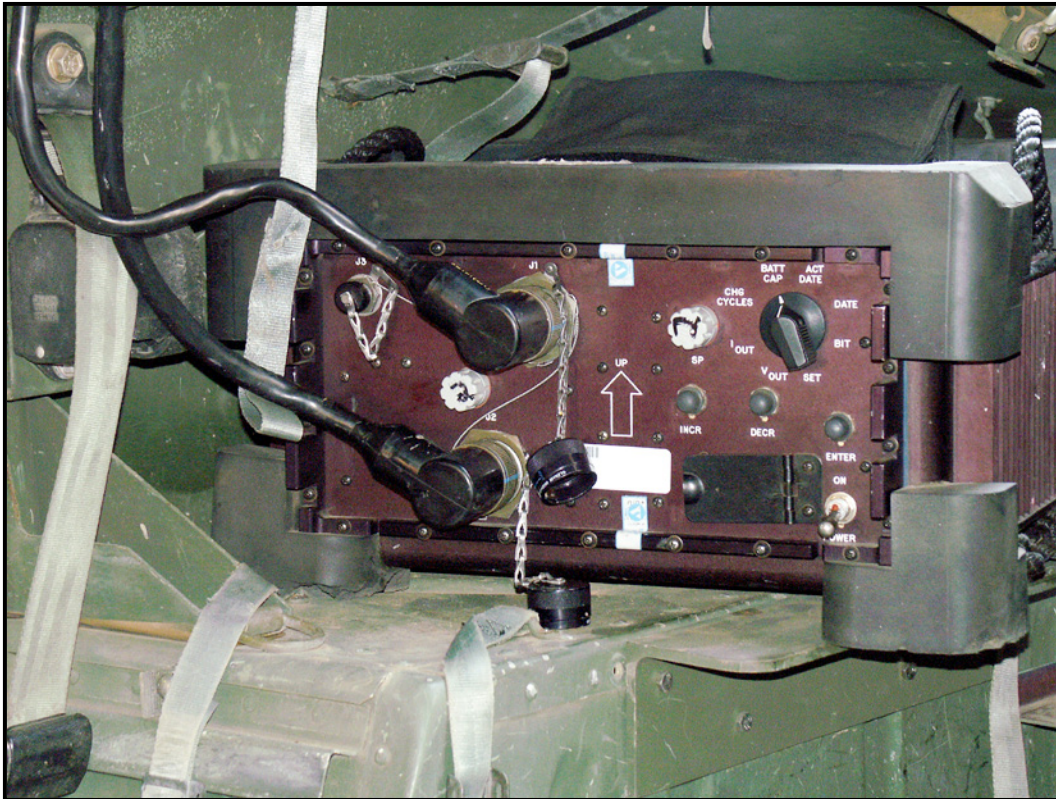


**Figure 3-18. Launch tube stowed on cargo shell door.**

- (b) Secures the launch tube nose to the mount with the strap.
- c. Stow the BPS on the HMMWV (Figure 3-19). The driver-loader—
  - (1) Carries the BPS to the HMMWV and stows it behind the rear passenger seat, facing forward.
  - (2) Secures the BPS in place with the straps.
  - (3) Connects the vehicle power cable to the BPS J1 connector and the HIC to the BPS J2 connector.

**NOTE:** Once the BPS power switch is placed in the ON position, do not change the setting unless dismounting the ITAS.

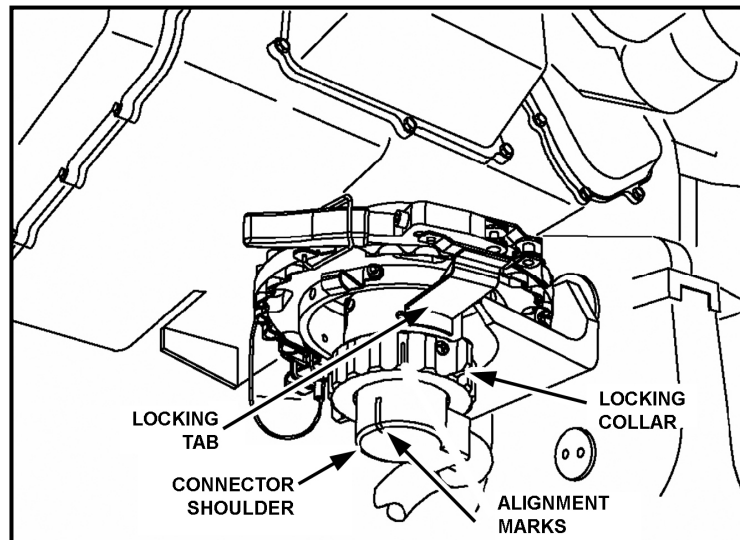
- (4) Places the BPS power switch in the ON position.
  - (a) Turns the function switch to BIT and checks the results of BPS PBIT.
  - (b) Turns the function switch to BATT CAP and checks the BPS internal battery capacity.



**Figure 3-19. BPS stow position.**

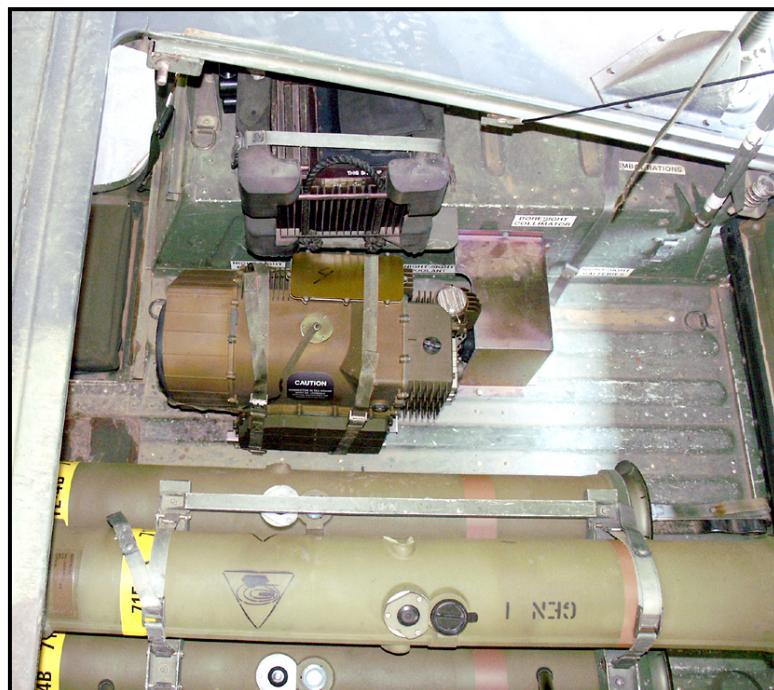
- d. Stow the TAS on the HMMWV. The gunner and the driver-loader perform the following procedures to stow the TAS on the HMMWV.
  - (1) The gunner—
    - (a) Replaces the TAS front window cover on the TAS front window.

- (b) Disconnects the TAS.
- (c) Opens the TAS mount coupling clamp.
- (d) Lifts the TAS from the TAS mount (Figure 3-20).



**Figure 3-20. TAS mount.**

- (2) The driver-loader—
  - (a) Stows the TAS in the HMMWV stowage cradle (Figure 3-21), strap side up.
  - (b) Secures the TAS with the two stowage straps.



**Figure 3-21. TAS stow position.**

e. Remove the TU from the tripod and stow it on the HMMWV. The gunner and the driver-loader perform the following procedures to remove the TU from the tripod and stow it on the HMMWV.

(1) The gunner—

(a) Replaces the TAS mount connector cover.

(b) Rotates the gunner handgrips to the stow position.

(c) Locks each limiter in the UP position.

(d) Closes the TAS mount coupling clamp.

(e) Releases the coupling clamp handle on the tripod to release the TU from the tripod.

(f) Removes the TU from the tripod by carefully lifting the TU from tripod while guiding the coil cable up through the body of tripod. (Figure 3-22).

**CAUTION**

Do not lift the TU by the gunner's handgrips.



**Figure 3-22. Removing the TU from the tripod.**

- (g) Sets the TU on its side on the ground ensuring the azimuth lock side is up.
- (h) Rolls the coil cable up tightly and secures it in the TU retainer cup.
- (2) The driver-loader—
  - (a) Carries the TU to the HMMWV.
  - (b) Stows the TU on the TU adapter (Figure 3-23).

**NOTE:** Install the TU adapter on the pedestal base, if not already installed.

- (c) Opens the upper coupling clamp handle on the TU adapter.

**CAUTION**

Do not lift the TU by the gunner's handgrips.

- (d) Picks up the TU, passes it through the rear door, holds it over the TU adapter, and carefully places it on the adapter.
- (e) Turns the TU so the bridge clamp handle is facing the rear of the vehicle.
- (f) Closes the upper coupling clamp handle and secures it with the locking spring on the TU adapter to secure the TU.



**Figure 3-23. TU stowed on the TU adapter.**

f. Stow the FCS on the HMMWV. The gunner opens the FCS stow bag; places the FCS inside, connector side down; and closes the stow bag. He picks up the FCS in the stow bag, carries it to the vehicle, and straps it to the gunner platform of the vehicle.

g. Stow the tripod in the HMMWV. The squad leader—

(1) Prepares the tripod for stowing (Figure 3-24).

(a) Removes any stakes from the tripod's anchor foot.

(b) Lifts the three lock handles all the way up to the release position.

(c) Lifts the tripod up so the legs fold into the body and locks the locking handles.



**Figure 3-24. Tripod.**

(2) Stows the tripod (Figure 3-25).

(a) Picks up the tripod and moves to the HMMWV.

(b) Places the tripod in the stow position on the vehicle.

(c) Fits the tripod head over the mounting bracket and secures the tripod with the coupling clamp.

(d) Straps the tripod in place.

(e) From rear of vehicle, raises and secures the tailgate and closes the cargo shell door.





**Figure 3-25. Tripod stow position.**

## **Section II. DISMOUNTED OPERATIONS**

Specific actions must be followed when dismounting the M41 ITAS and moving it to the firing site. All actions happen simultaneously.

### **3-11. DISMOUNT ACTIONS**

Each crewmember begins executing his assigned responsibilities as soon as the squad leader commands "DISMOUNT THE ITAS."

a. **Squad Leader's Actions.** The squad leader—

- (1) Turns the BPS to the OFF position.
- (2) Dismounts and goes to the rear of the vehicle; opens the cargo shell door using the rear latch; lowers the tailgate; removes the tripod and places it on the ground by the launch tube (on the left front side of the vehicle in front of the FCS and the TAS); and closes the tailgate and cargo shell door.
- (3) Receives the BPS from the driver-loader and places it on the ground to the left side of the vehicle.

(4) Carries the tripod and the launch tube to the firing site.

b. **Gunner's Actions** (assisted by driver-loader when needed). The gunner—

- (1) Disconnects the coil cable and the HIC from the FCS.
- (2) Removes the TAS and hands it to the driver-loader who places it on the ground on the left side of the vehicle.

(3) Removes the launch tube and hands it to the driver-loader who places it on the ground in front of the TAS.

(4) Unlocks the top coupling clamp on the TU adapter; removes the TU (minus the adapter) places the coil cable in its retaining cup on the TU; and hands the TU to the driver who places it on the ground behind the TAS.

(5) Unstraps the FCS and hands it to the driver-loader who places it on the ground beside the TAS.

(6) Unstraps a missile and hands it to the driver-loader who places the missile on the ground behind the TU. The gunner then closes the cargo shell door and dismounts the vehicle.

(7) Carries the TAS and the FCS to the firing site.

c. **Driver-Loader's Actions.** The driver-loader—

(1) Dismounts the vehicle removes the BPS and passes it to the squad leader through the cargo hatch door

(2) Removes the FCS container placing it beside the TAS, and waits to receive equipment from the gunner.

(3) Carries the TU on the first trip, the BPS on the second trip and the missile on the third trip.

### 3-12. DISMOUNTED FIRING POSITIONS

When the ITAS is assembled for ground emplacement, the tripod must be level for effective operation of the weapon. If the tripod is not level, lateral (azimuth) movement of the TU produces a change in the elevation angle of the launch tube; therefore, acquiring and tracking the target may be difficult. An unlevel tripod can cause an electronic control error during the final tracking operation (while the command-link wire is guiding the missile to its target).

a. For ground emplacement, proper adjustment of the tripod legs compensates for uneven ground up to a slope of 30 degrees. Therefore, the firing position must not slope more than 30 degrees. When the tripod legs are properly positioned, the bubble in each level will be between the marks on the level indicator.

b. The ITAS is not fired from a position where the TU has a lateral cant of more than 10 degrees. The ideal firing position is as level as possible. However, the missile can be fired from a position where the tripod is canted as much as 30 degrees directly downhill or uphill.

c. After the site is selected and the weapon emplaced, the squad leader and gunner make a range card for the position. (For detailed information on making a range card, see Appendix D.)

### 3-13. FIRING POSITION ACTIONS

Upon reaching the firing position, the crew proceeds with the following actions.

a. **Squad Leader's Actions.** The squad leader—

(1) Sets up the tripod with the coupling clamp handle facing the direction of fire and unlocked.

(2) Pulls the coil cable out of the traversing unit retaining cup, installs the launch tube, and observes downrange for enemy targets.

(3) Issues fire commands.

- b. **Gunner's Actions.** The gunner—
- (1) Places the FCS on the ground next to the tripod and installs the TAS on the TU.
  - (2) Connects the coil cable to the FCS J2 connector and the interface cable to the BPS J2 and the FCS J1.
  - (3) Conducts the system checkout IAW TM 1425-923-12.
  - (4) Engages the target upon receipt of the fire command.
- c. **Driver-Loader's Actions.** The driver-loader—
- (1) Installs the TU on the tripod.
  - (2) Returns to the vehicle for the BPS; places the BPS on the ground at the firing position to the left side of the weapon system.
  - (3) Returns to the vehicle for the missile and moves back to the firing position with it, where he loads it and arms it if commanded.

**This page intentionally left blank.**

---

## CHAPTER 4

# FIRING TECHNIQUES

*This chapter discusses the techniques and procedures of fire control, target engageability, and firing the ITAS under limited visibility and NBC conditions. These techniques and procedures greatly enhance the performance of the ITAS in combat and increase the chances of survival for the crew.*

### Section I. FIRE CONTROL MEASURES

The success of the antiarmor units in combat depends on how quickly and effectively they engage targets. All antiarmor fires must be controlled to ensure full coverage of the target area and to minimize multiple engagement of a single target. Effective control and distribution of fires is paramount to combat success. Fire control must become routine without need for detailed instructions. Some conditions may limit the firing and engagement capabilities of the ITAS. Consider the following information before engaging targets. (See TM 9-1425-923-12 for updated firing limitations.)

#### 4-1. FIRING OVER WATER

Firing across bodies of water wider than 1,100 meters can reduce the range of the ITAS. Signals being sent through the command-link wires are shorted out when a large amount of wire is submerged in water. If the range is less than 1,100 meters, the missile's range is not affected. Maximum and limited firing ranges over water vary according to missile type. An ITAS position should be as high above and as far back from the water as the tactical situation allows. The squad or section leader should analyze his sector as soon as the position is occupied to determine if water will affect the employment of the ITAS.

a. TOW missiles may be fired over water to a maximum range as shown in Figure 4-1.

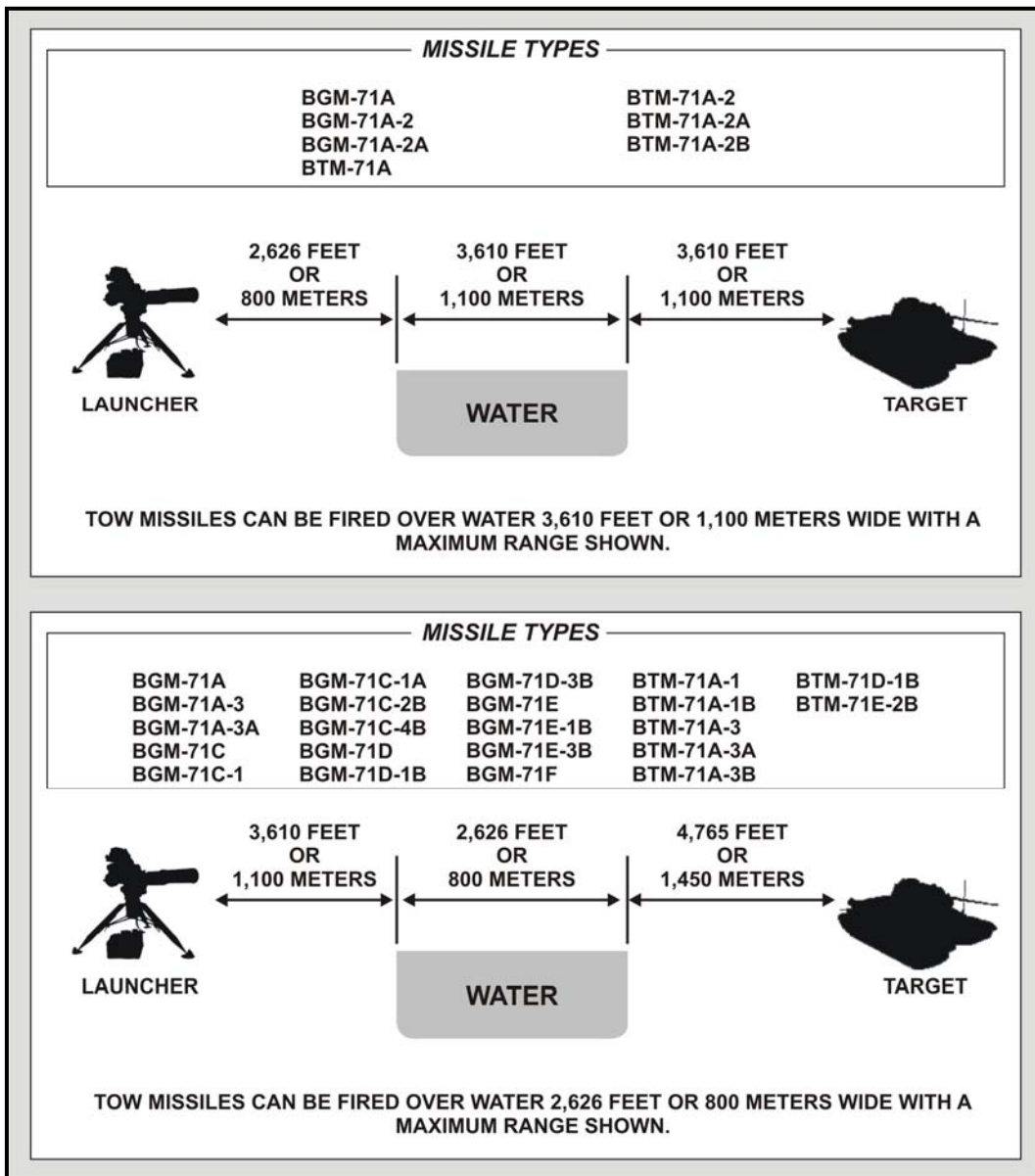


Figure 4-1. Maximum TOW range over water.

b. TOW missiles may be fired over water to a limited range as shown in Figure 4-2.

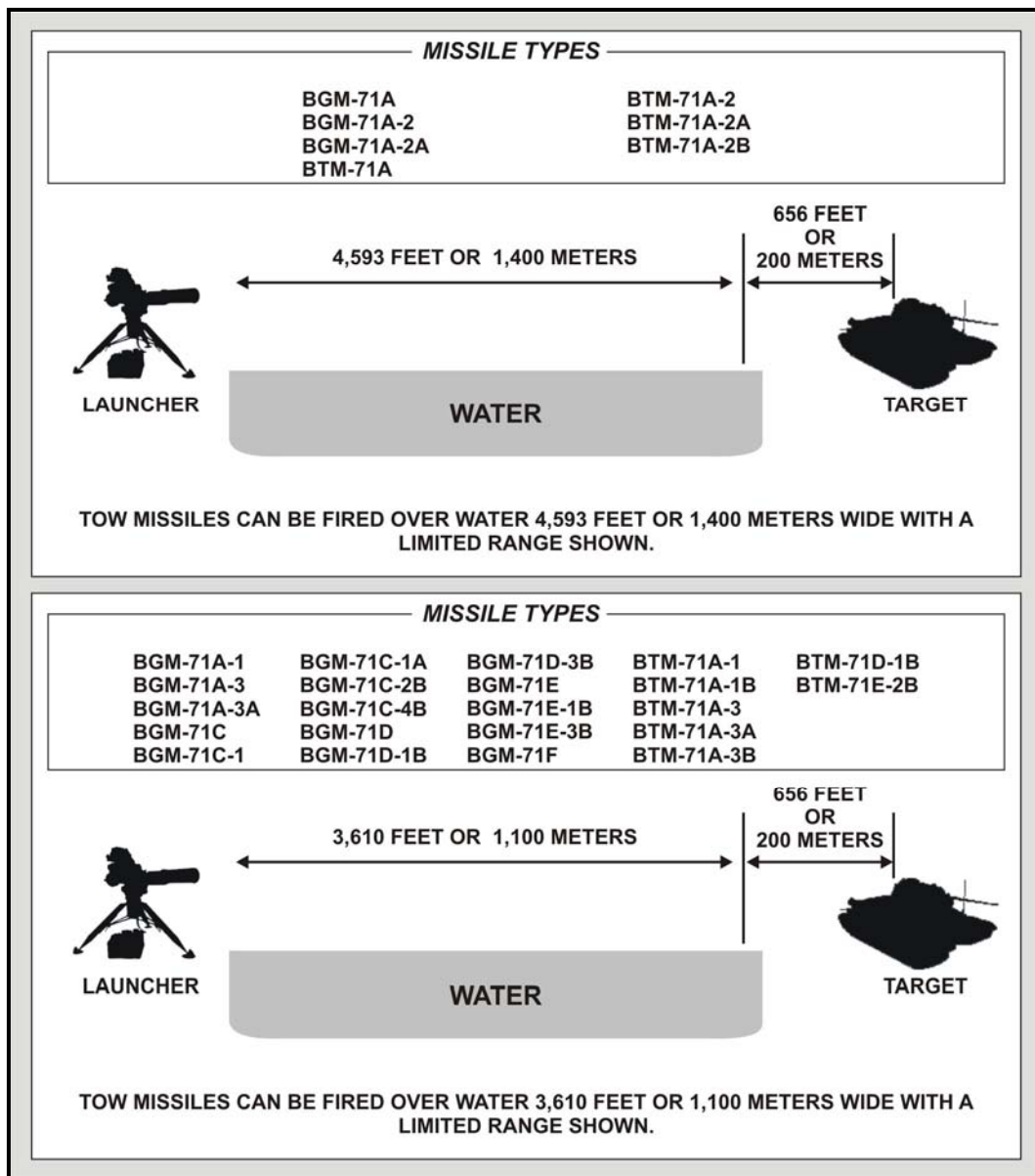


Figure 4-2. Limited TOW range over water.

c. To determine the extended range of missiles when firing over water (when ITAS launcher or target is above surface level of water), use Tables 4-1 through 4-4 (pages 4-4 through 4-7).

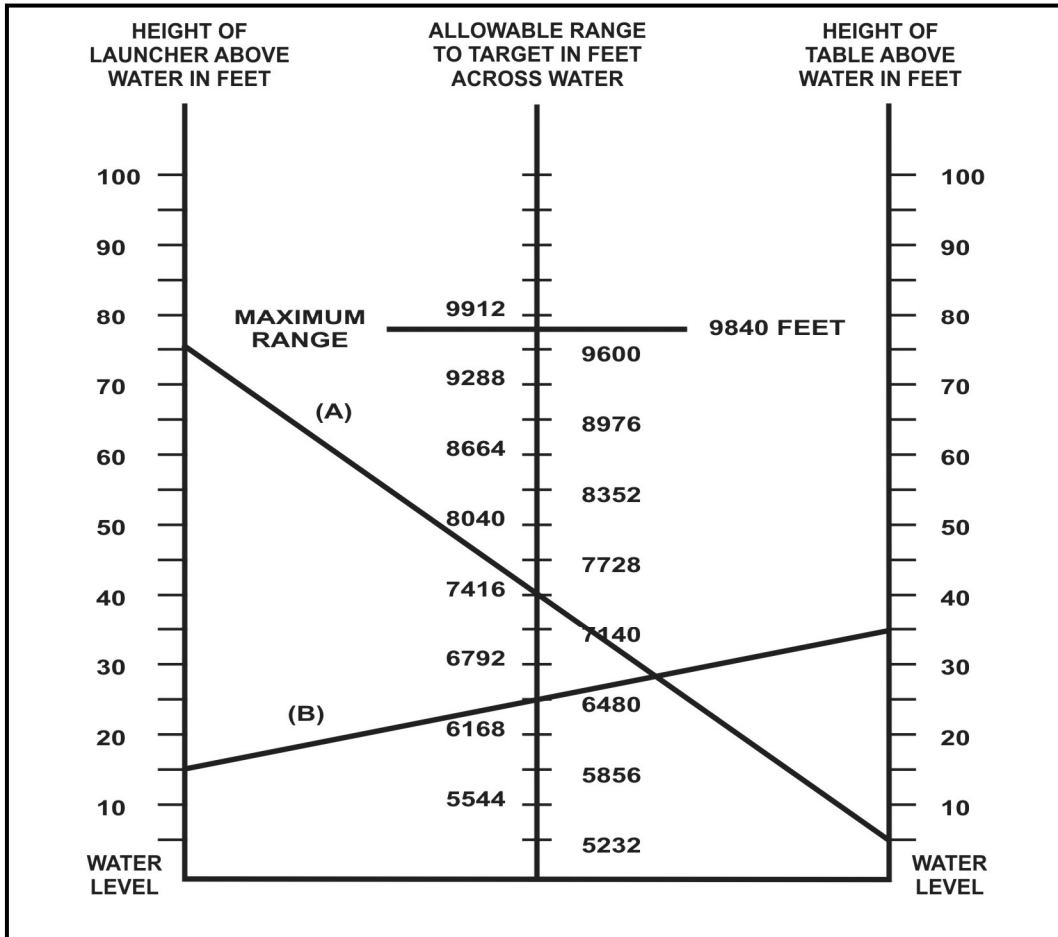


Table 4-1. Range per height above water for TOW missiles BGM-71A-2, BTM-71A, or BTM-71A-2.



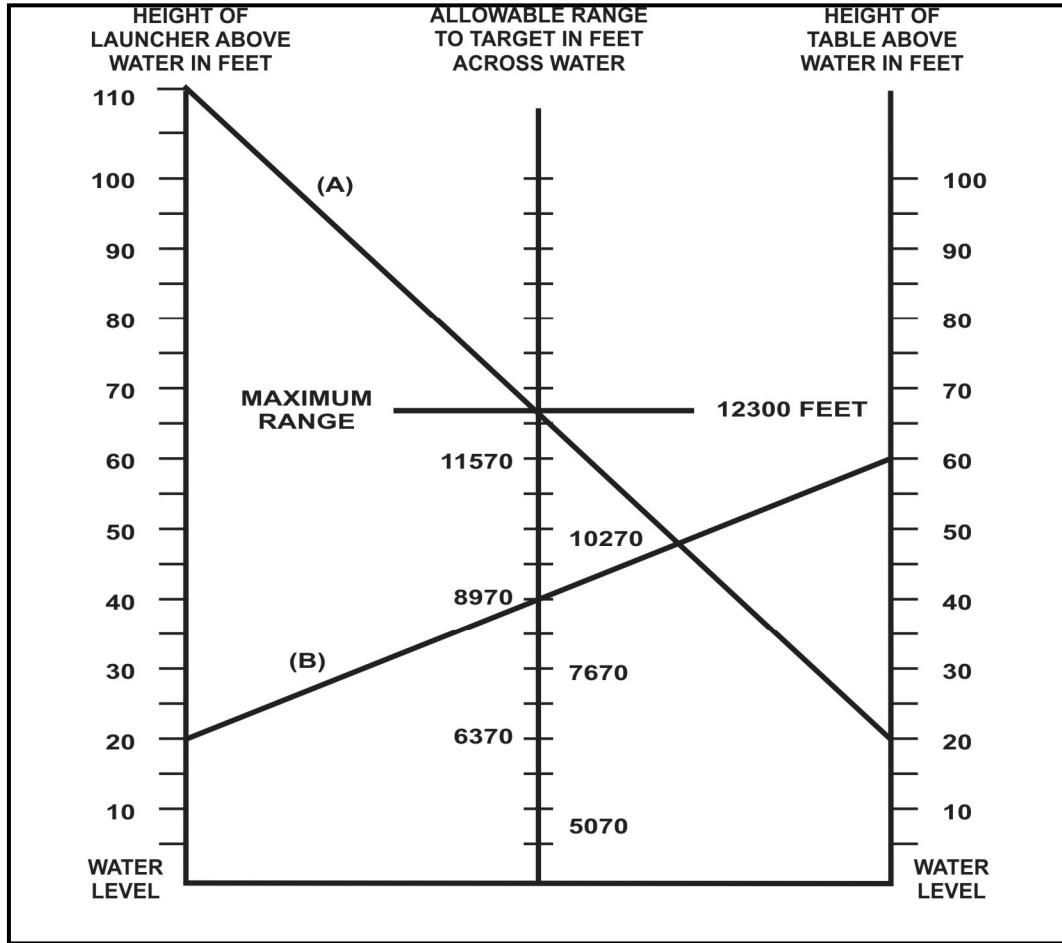


Table 4-2. Range per height above water for TOW missiles BGM-71A-1, BGM-71A-3, BTM-71C, BGM-71C, BGM-71D, BTM-71A-1, or BTM-71A-3.

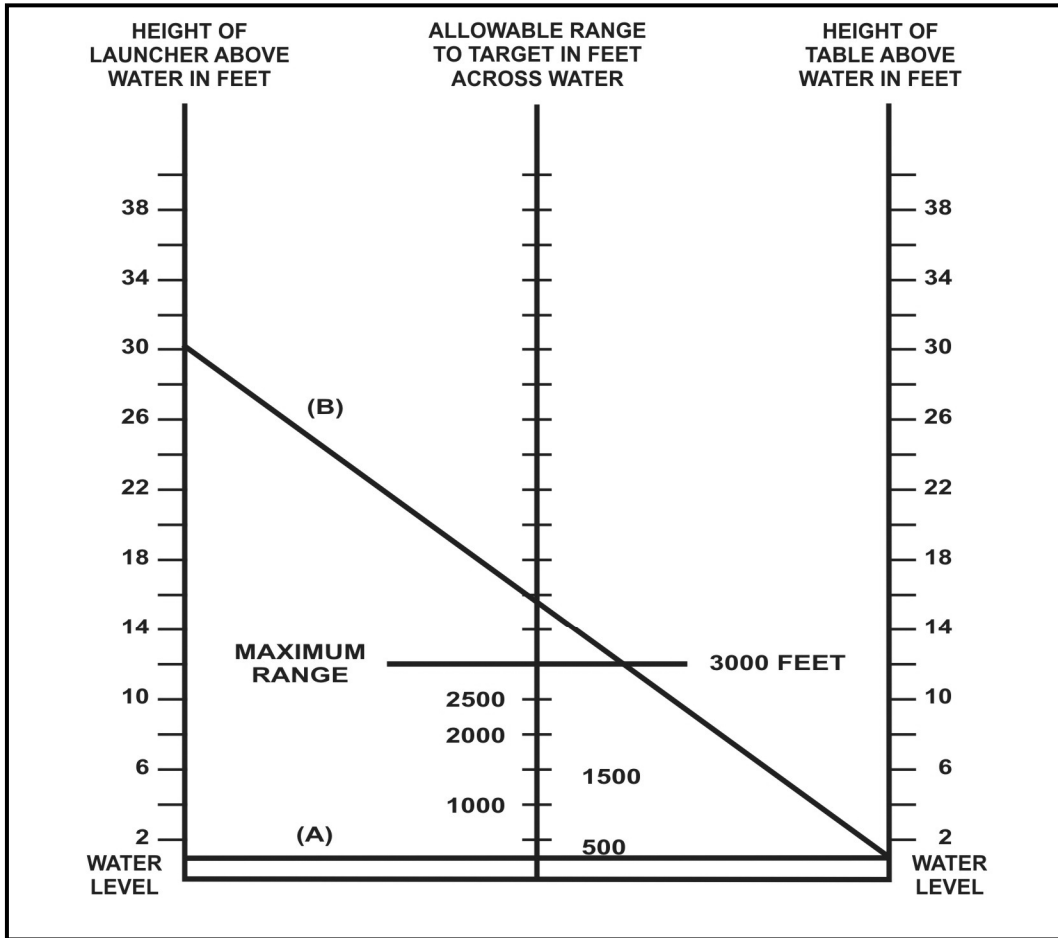
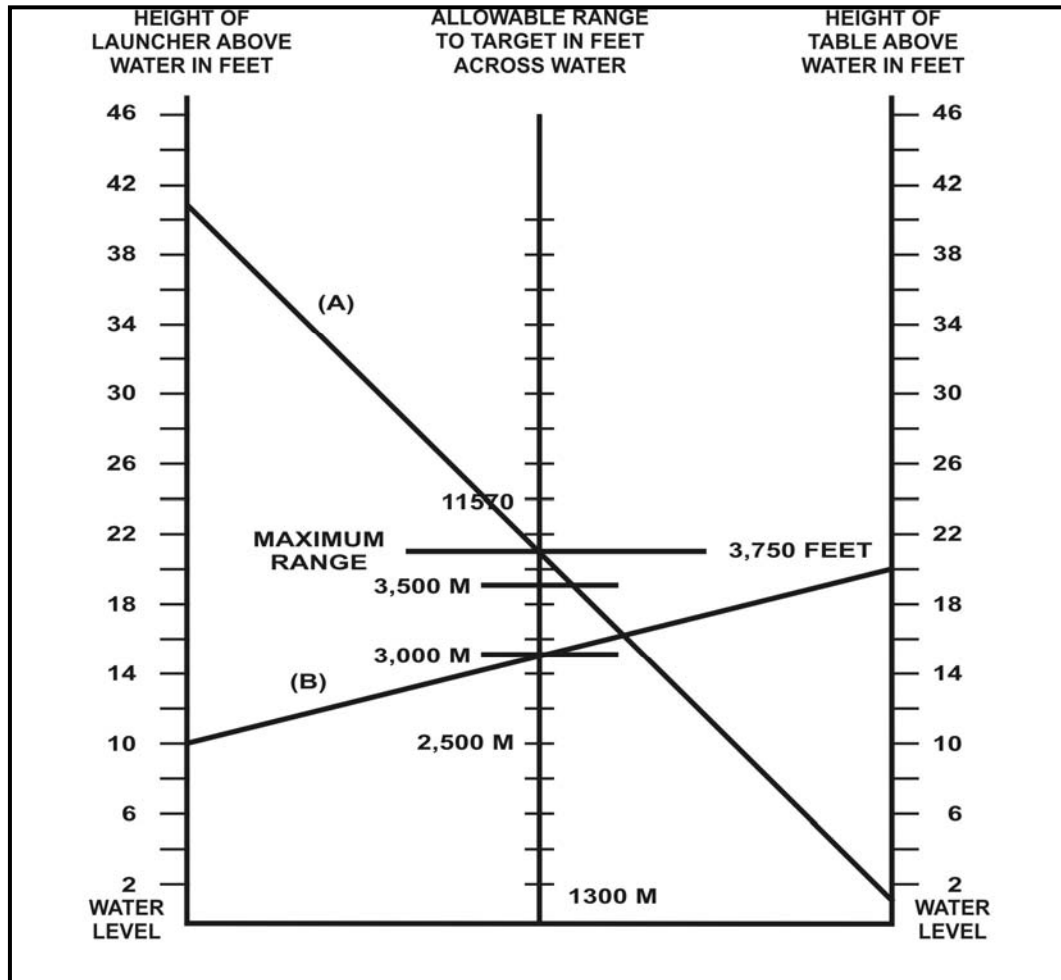


Table 4-3. Range per height above water for TOW missiles BGM-71A, BGM-71A-2, BTM-71A, or BTM-71A-2.



**Table 4-4. Range per height above water for TOW missiles BGM-71A-1, BGM-71A-3, BTM-71A, BTM-71C, BGM-71C-1, BGM-71D, BTM-71A-1, or BTM-71A-3.**

- (1) Determine the type of missile being used.
- (2) Determine the height above the water surface of the ITAS and place a tick mark at the corresponding height in the left-hand column of the table.
- (3) Determine the height above the water surface of the target. Place a tick mark at the corresponding height in the right-hand column of the table.
- (4) Connect the two tick marks with a straight line. The point where the lines intersect the center column is the maximum range the missile can travel without getting too close to the water.

#### **4-2. FIRING OVER ELECTRICAL LINES**

If the command-link wires contact a live high-voltage power line, personnel can be injured, control of the missile can be lost, and the launcher electronics may be damaged. In addition to power lines, other high-voltage sources include street cars, electric train ways, and some moving target trolleys on training ranges.

#### 4-3. FIRING IN WINDY CONDITIONS

Gusty, flanking, or quartering winds can cause the launch tube to vibrate and spoil the tracking performance. The effect is similar to driving in a strong crosswind. Erecting a windscreen next to the launcher helps to reduce this problem. Strong winds can move the missile around during flight, but as long as the crosshairs are kept on the center mass of the target, the weapon system itself can compensate for wind effects.

#### 4-4. FIRING THROUGH SMOKE AND AREA FIRES

Smoke can obscure the line of sight and hide the target when using the daysight. Whenever obscuration is encountered the gunner should switch to the NVS mode. Fire can burn through the command-link wire, causing loss of control of the missile. The gunner should avoid firing through fire and over fires if there is a possibility that the wires will contact the fire before missile impact.

#### 4-5. FIRING FROM BUNKERS AND BUILDINGS

TOW missiles will not be fired from buildings or bunkers, or within 100 meters of a vertical or nearly vertical backstop without the approval of the commanding general (IAW AR 385-63).

#### 4-6. CLEARANCE REQUIREMENTS

TOW missiles must have at least 9 inches of clearance at the end of the launch tube so the wings and control surfaces of the missile will not be damaged when they extend after clearing the launch tube. The muzzle of the launch tube must extend beyond any enclosure, windowsill, or aperture, and at least 30 inches of clearance must be between the line of sight and any obstruction from 500 to 900 meters downrange. A 30-inch line-of-sight clearance ensures a high probability the missile will not strike the ground on the way to the target (Figure 4-3). These clearance requirements, along with all TOW missile limitations, must be taken into account before engaging targets with the ITAS.

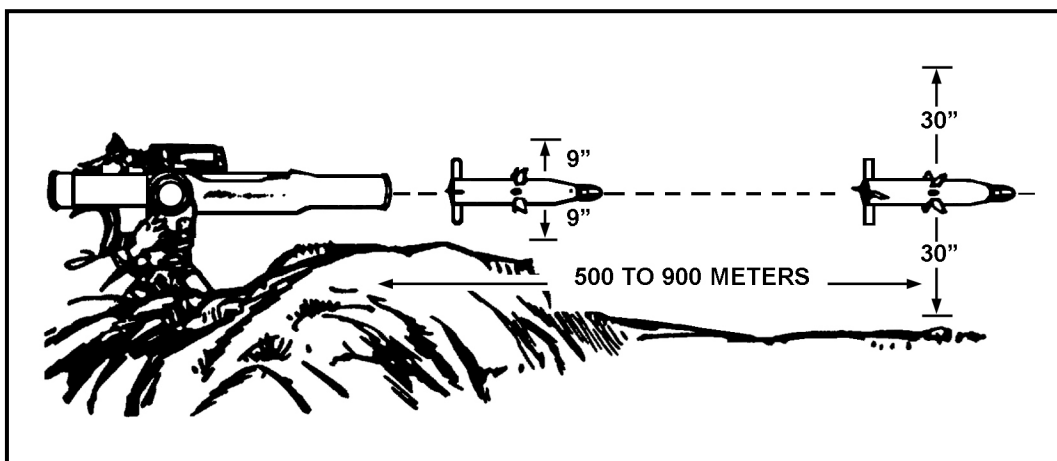


Figure 4-3. Clearance requirements.

## Section II. TARGET ENGAGEABILITY

Tanks and mechanized units are trained to use terrain-driving techniques to conceal movement, and drivers are taught to move vehicles quickly from one concealed position to another. ITAS gunners and squad leaders must determine the range to a target and determine if the exposure time (the time a vehicle is in a gunner's sight) is long enough to allow a missile to reach its target. Antiarmor crewmen must understand that many armored forces worldwide operate with a "wingman" concept whereby, at the first sign of an antiarmor missile launch, vehicles scan sectors and engage with whatever ammunition is loaded.

### 4-7. DETERMINE IF A TARGET IS WITHIN RANGE

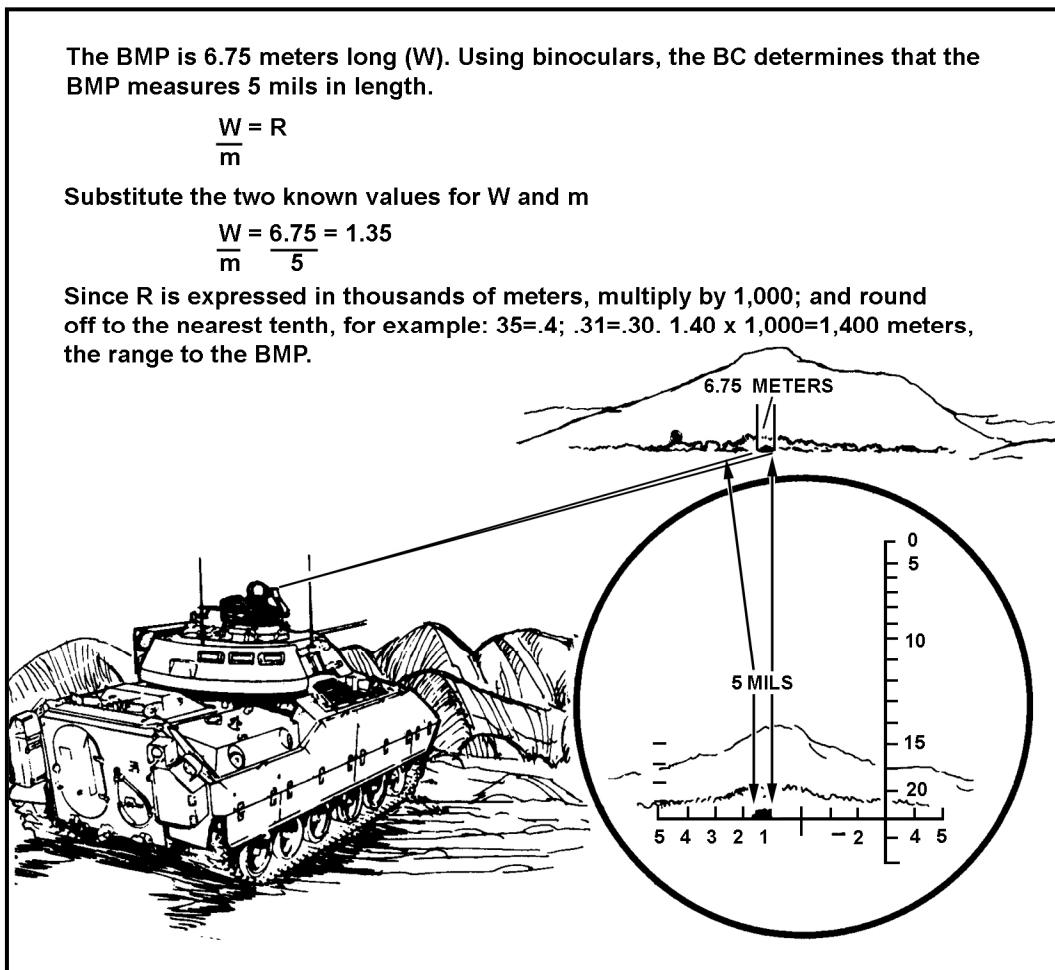
The ITAS gunner or squad leader can use the daysight, nightsight, or binocular method to determine if a target is within range.

a. **Daysight Method.** When in daysight mode, the ITAS gunner uses passive or active ranging to determine the range to a target. (See TM 9-1425-923-12 for more information on how to use passive and active ranging.)

b. **Night Vision Sight Method.** When in NVS, the ITAS has both an active and passive LRF. The passive mode is preferred because the active range finding mode emits a laser that may be detected by laser detection devices used on some modern armored vehicles. The passive method uses a box in the same manner as the ATT track gate.

c. **Binocular Method.** Use the reticle in binoculars to determine if a target is within range by looking at the length, width, or height of the vehicle. Follow the same procedures when using the M17 and M19 binoculars, even though the reticles differ slightly. The M17 tick marks are only 1.7 mils long while the tick marks on the M19 reticle are 5 mils long (2.5 mils on each side of the horizontal and vertical scales).

(1) To determine if a target is within range at 3,000 meters based on the length of the target, place the length of the target on the vertical scale. If one-third or more of the vehicle extends beyond the tick mark, the vehicle is in range (Figure 4-4, page 4-10). A vehicle 6.5 meters long will measure about 2.2 mils at 3,000 meters and about 1.7 mils at 3,750 meters.



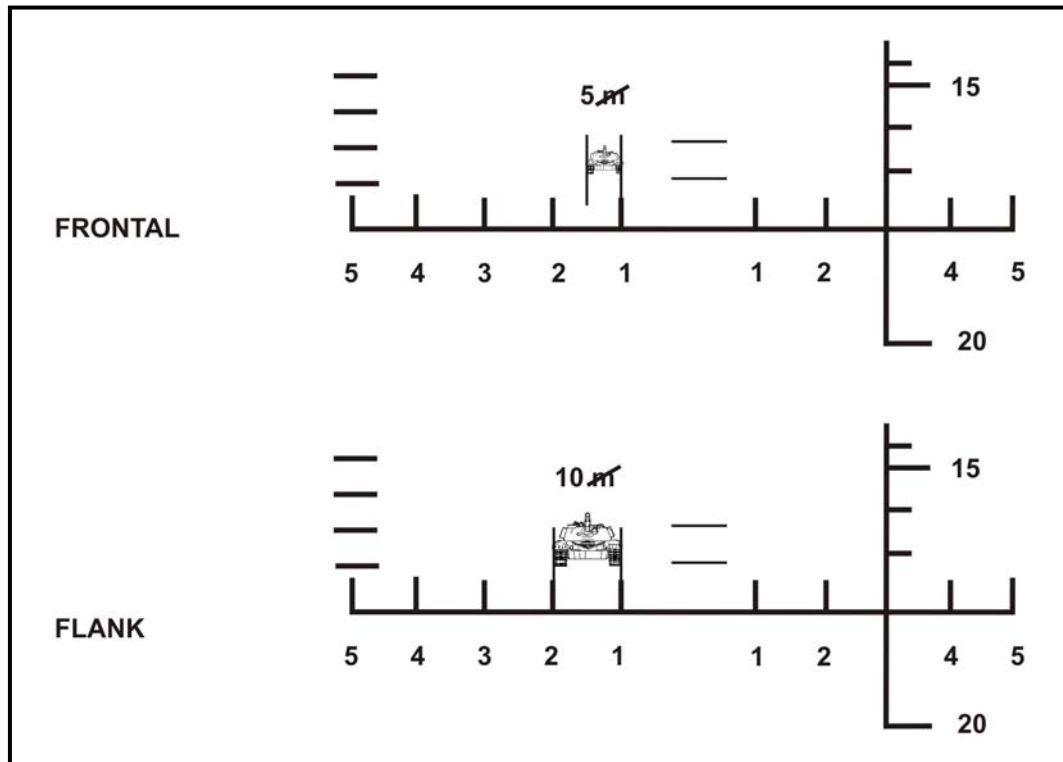
**Figure 4-4. Range determination using binoculars.**

(2) To determine if a target is within range at 3,000 meters based on the width of the target, place the target on the small tick mark on the vertical scale. If the target covers two-thirds or more of the tick mark, the vehicle is within range. A vehicle 3.4 meters wide will measure 1.1 mils at 3,000 meters and .85 mils at 3,750 meters. (Most former Warsaw Pact APCs are less than 3.4 meters wide and can be engaged at smaller mil values.)

(3) To determine if a target is within range at 3,000 meters based on the height of the target, place the target on one of the tick marks on the horizontal scale. If the height of the vehicle is one-half or more of the height of one of the tick marks, the vehicle is within range. A vehicle 2.4 meters high (the size of most former Warsaw Pact vehicles), will measure .8 mils at 3,000 meters and .6 mils at 3,750 meters.

(4) The mil-relation formula is: known target measurement (W) divided by the mil measurement equals the range factor (R). The range factor is then multiplied by 1,000 to determine the target range. To determine if a target is within range using the mil-relation formula, the gunner determines the known width, height, or length with the binocular's mil scale, substitutes the mil relation, and computes the range. When measuring frontal width, he measures only the vehicle's front slope (from left front corner to right front

corner). When measuring flank width, he measures the entire vehicle (Figure 4-5). Accuracy of this method depends on knowing the target dimensions and on the gunner's ability to make precise measurements with the binoculars.



**Figure 4-5. Target measurement using binocular reticle.**

(a) The mil is a unit of angular measurement equal to  $1/6400$  of a circle. There are about 18 mils in 1 degree. One mil equals the width, height, or length of 1 meter at a range of 1,000 meters. This relationship remains constant as the angle or range changes. Standard Army measurements use the metric system. Other units of measurement (yards, feet, or inches) may be substituted to express the target size or range; however, all information must be expressed in the same unit of measure.

(b) The relationship of the target width in mils and meters ( $W$ ) is constant at varying distances, which makes accurate range determination possible. The mil relation holds true whether the  $W$  factor is width, height, or length. Therefore, the range can be determined if the target dimensions are known. Target height may be the most consistent measurement, because length and width change as targets move on the battlefield. Also, target height is used to determine “battle carry” (the pre-indexed range and ammunition) used during offensive operations.

- NOTES:**
1. The distance between tick marks on the horizontal scale is 10 mils.
  2. If the weapon system is in an elevated firing position or if the lower portion of the target vehicle is hidden by foliage or terrain, the binocular method cannot be used.

#### 4-8. DETERMINE EXPOSURE TIME

The half-sight method of determining exposure time is based on a vehicle speed of 35 kilometers per hour (the expected top vehicle speed of armored vehicles on level or gently sloping dry terrain).

a. **Daysight Method.** Use the cross lines on the daysight tracker to determine the exposure time of a target.

(1) Place the cross lines of the daysight tracker on the center of the visible mass of the vehicle.

(2) In the NFOV, if the area between the vertical cross line and the edge of the field of view in the direction of travel is clear of obstruction, the target is engageable.

(3) If obstructions appear between the vertical cross line and the edge of the field of view, the time of exposure would not be long enough for the missile flight before the target moved out of sight.

b. **Nightsight Method.** The procedure to determine exposure time is the same for the nightsight as for the daysight, except the nightsight must be set on narrow field of view.

c. **Binocular Reticle Method.** Use the reticle in the binoculars to determine the exposure time of a target.

(1) Place the zero tick mark of the horizontal scale at the center of the vehicle.

(2) If the area between the vehicle and the 50-mil tick mark is clear of obstructions in the direction of travel, the target is engageable (Figure 4-6).

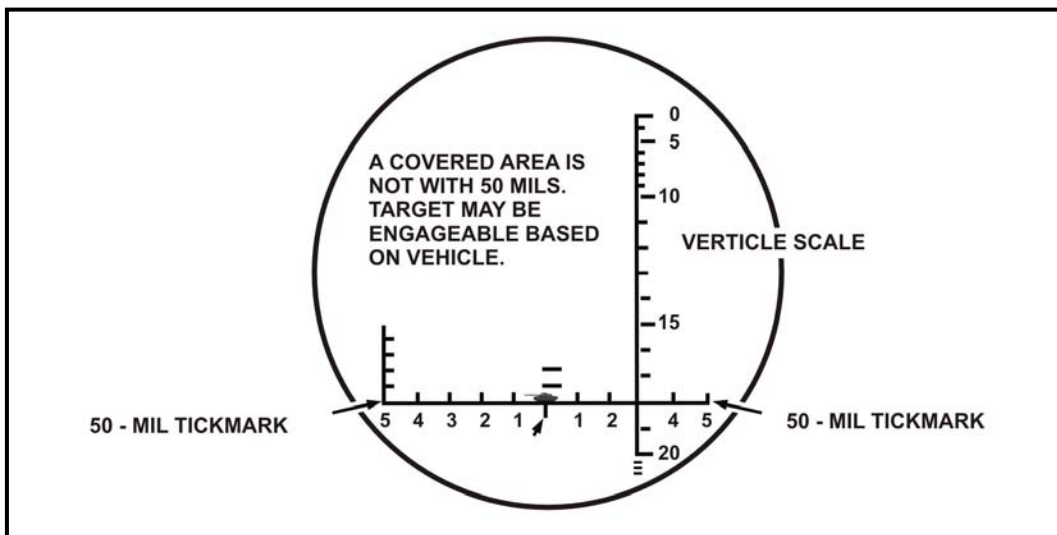


Figure 4-6. Binocular reticle method.

#### 4-9. FIRE COMMANDS

The six elements of a fire command are: alert, type of missile, target description, target direction, range, and execution. Additional commands may be used after execution, depending on the situation, to let crewmembers know what is to be done next. Whether



mounted or dismounted, the elements of the fire command are the same. (Figure 4-7 shows an example of a squad fire command.)

<b>SQUAD LEADER:</b>	SQUAD, TOW2B MISSILE; ONE TANK NORTH OF TRP 1; 2,000 METERS; AT MY COMMAND.
<b>GUNNER:</b>	IDENTIFIED.
<b>SQUAD LEADER:</b>	FIRE.
<b>SQUAD LEADER:</b>	CEASE TRACKING, OUT OF ACTION.

**Figure 4-7. Example of a squad fire command.**

a. **Alert.** The first element of the fire command alerts the crew for an immediate engagement. The squad leader commands, “Squad,” and the gunner begins observing the target area.

b. **Type of Missile.** Because a variety of TOW missiles are used and their capabilities vary, a particular type of missile must be specified. An ITAS crew in battle will probably have a mix of different missiles and a wide variety of target arrays to engage (see FM 3-22.34 [FM 23-34] for TOW missile types and configurations). For example, if the target is a BTR-60 or BMP-1, the squad leader may command, TOW 2; if the target is a T-80 with reactive armor, he may command, TOW 2B. All TOW missiles in production are line-of-sight missiles except the TOW 2B. The TOW 2B is normally a FOSD missile but, with the capabilities of the ITAS, can be changed to a line-of-sight missile.

c. **Target Description.** The second element identifies the target for the gunner. If several similar targets are present, this element tells the gunner which target to engage first. Most targets can be described using the terms listed in Table 4-5, page 4-14. Targets that are combinations of the ones listed in Table 4-5, such as a truck mounting a missile system, are identified by combining terms—for example, TRUCK MOUNTING ANTITANK. When the gunner sees the target, he announces, “Identified.” If multiple targets appear, the commander may specify which target will be engaged by the gunner—for example, FIRST TANK or RIGHT TRACK.

TARGET	ANNOUNCED AS
Any tank or tank-like vehicle	<b>TANK</b>
Several tanks	<b>TANK FORMATION</b>
Any unarmored vehicle	<b>TRUCK</b>
Any halftrack or armored personnel carrier	<b>TRACK</b>
Helicopters	<b>CHOPPER</b>
All fixed-wing aircraft	<b>PLANE</b>
Personnel	<b>TROOPS</b>
Any machine gun	<b>MACHINE GUN</b>
Any antitank gun or towed artillery piece	<b>ANTITANK</b>
Any other target	<b>A short word or phrase that clearly describes the target.</b>

**Table 4-5. Terms used to describe targets.**

d. **Target Direction.** If the target is moving, the direction of movement is given after the description to aid the gunner in locating the target. After the gunner is given the location of a target, he can search for the target in the direction of movement. A target reference point (TRP) can also be used to help the gunner locate the target. A TRP is an easily recognizable feature or point on the ground (either natural or man-made) used for identifying targets and controlling fires. They can be used to designate targets for companies, platoons, sections, and individual weapons. They can also be used to designate the center of an area where the commander plans to distribute or converge the fires of all his weapons. TRPs are usually designated by the company commander or platoon leaders. Weapons will engage targets from different directions, so compass points (for example, north, east), rather than “right” or “left,” are used when giving directions centered on a TRP.

e. **Range.** The range is given to help the gunner identify his target and to determine its engageability. The squad or section leader can determine the range to the target using the naked eye, binoculars (mil-relation formula), or reference materials (maps, range cards).

(1) **Naked Eye.** One method for using the naked eye to determine range is the football field method. The squad or section leader counts in 100-meter increments, estimating the number of football fields that could fit between the firing position and the target.

(2) **Binoculars.** Binoculars and the mil-relation formula can be used to determine range. To use this method, the squad or section leader must know the width, height, or length of the target. He determines the width, height, or length with the mil scale on the binoculars; substitutes the mil-relation; and computes the range.

(3) **Reference Materials.** Maps can be used to determine range by counting the grid lines between the firing position and the target or by adjusting from a known point. Range cards can also be used to determine the range to the target.

f. **Execution.** Two commands are necessary for execution: a preparatory command and a command of execution.

(1) AT MY COMMAND is a preparatory command that warns the gunner not to fire until given the command of execution.

(2) FIRE is the only command of execution used to fire a missile.

g. **Additional Commands.** In addition to the six elements of the fire command, some other commands are needed.

(1) The command CEASE TRACKING or CEASE TRACKING, OUT OF ACTION is issued after seeing the round detonate or when the squad or section leader wants to halt firing.

(a) CEASE TRACKING tells the crew the squad or section leader intends to stay in position and engage another target immediately or when one appears.

(b) CEASE TRACKING, OUT OF ACTION tells the crew the squad or section leader intends to move to another position.

(2) To determine the method of engagement, the section leader (or above) selects a fire pattern depending on the opposing force's formation. The section leader directs, FRONTAL, DEPTH, or CROSSFIRE when the gunner is faced with multiple targets.

(3) When the target is identified, the gunner announces, "Identified."

(4) If the gunner cannot see the target, he announces, "Lost."

(5) If the gunner cannot identify the target, he announces, "Cannot identify."

(6) The loader announces, "Backblast clear," before the command of execution is given.

h. **Repeating Commands.** When a crewmember fails to hear or understand any element of a fire command, he announces the element in question. For example, if the gunner asks, "Location?" the squad leader repeats the location element such as, "From hill seven six two, west two hundred."

i. **Correcting Errors.** To correct an error in a fire command, the squad leader announces, "Correction," and corrects only the element in error. He completes the command by announcing all elements after the corrected element. He does not try to correct an element that has been needlessly included, such as the direction element. He corrects the omission of an element by announcing "Correction" and then the omitted element. After announcing the omitted element, he completes the command.

j. **Commands for the Driver.** Although directions to the driver are not part of the fire command, the squad leader or gunner gives them in short terms.

#### 4-10. TARGET TRACKING

To track a target, the gunner visually acquires the target through the TAS

a. **Manual Engagement.** To track the target, after target engageability has been determined, the gunner operates the hand controls on the traversing unit to keep the reticle in the launcher sight aligned with the target. The TAS is attached to and aligned with the launch tube. The launch tube stabilizes the exit of the missile from the launcher for alignment during initial missile flight. On achieving target alignment, the gunner fires the missile by manually depressing the trigger switch. Thereafter, all operations are automatic and the gunner's only task is to maintain alignment of the sight reticle and the target until missile impact.

b. **Aided Target Tracker Engagement.** After target engageability has been determined, the gunner activates the ATT (adjust, size, and lock). If the ATT will not

lock after the second attempt, the gunner must engage in the manual mode. All actions are the same as described in the daysight method of engagement.

c. **Deviations.** Deviations of the missile from the line-of-sight trajectory are sensed in the launcher sight by infrared means that receive information from infrared radiators attached to the missile. This information is processed in the form of electrical signals to produce error signals proportional to the azimuth and elevation displacements of the missile from the intended trajectory. Correction commands are derived from these error signals and are sent to the missile over the command-link wires, which are dispensed from the missile. The missile performs corrective maneuvers using aerodynamic control surfaces that deflect in response to the command signals from the launcher. On target impact, a high-explosive, shaped-charge warhead is detonated.

#### **4-11. HELICOPTER ENGAGEMENT**

Enemy armor is the primary threat to friendly ground forces employed in forward areas. The primary mission of the ITAS is the destruction of these tanks at the greatest possible range. However, ITAS gunners can also successfully engage attacking enemy helicopters, which are a significant threat to ground forces. Engaging helicopters with the ITAS should be considered primarily as a means of self-defense. ITAS crews should not consider helicopters as a routine target of opportunity, but should leave them to conventional ADA assets when possible. Launch warning receiver technology available worldwide makes engagement of rotary-wing aircraft potentially a dangerous action.

a. ITAS positions are selected to cover armor avenues of approach, but these long-range fields of fire also facilitate the engagement of aircraft. The section leader's, squad leader's, and crew's observation from these positions can provide the early warning required to successfully engage aircraft.

b. The engagement of attacking helicopters should be done by ITAS sections, not individual weapon systems. ITAS sections should automatically engage helicopters that are attacking their positions. If one squad in a section is being attacked by a helicopter, the other squad should engage the helicopter while the first squad seeks cover. ITAS crews and sections should be trained to automatically respond to helicopter attacks in this manner.

## CHAPTER 5

# TACTICAL CONSIDERATIONS

*This chapter discusses tactical considerations, capabilities, and limitations of the TOW weapon system in conjunction with the ITAS. To integrate the ITAS into tactics and techniques, the leadership from the company commander down to the squad leader must be familiar with the field manuals appropriate to the organizations and to the organizational level (FMs 3-21.9, 7-7, 3-21.71, 7-8, 7-10, or 3-21.91).*

*This chapter also discusses how to construct a fighting position that provides the crew with good cover and concealment while allowing for the best possible engagement of the enemy.*

### Section I. PURPOSE AND FUNDAMENTALS

The purpose of the TOW is to destroy enemy armored vehicles out to 3,750 meters. The ITAS has replaced the TOW's M220A2 sight system in selected infantry units. Commanders may use the TOW and ITAS in various roles from supporting fire to conducting surveillance. Commanders must understand the unique capabilities and limitations of the TOW and the ITAS to enhance the unit's combat power.

#### 5-1. FUNDAMENTALS OF EMPLOYMENT

Using the fundamentals of antiarmor employment increases the probability of destroying targets and enhances the survivability of the antiarmor elements.

a. **Mutual Support.** Units provide mutual support to each other by their relative positions (with respect to each other and the enemy) and their inherent capabilities. Mutual support is established by employing the ITAS by section and by overlapping sectors of fire between sections.

(1) **Employment.** Employment of the ITAS by section establishes mutual support. If one section is attacked or forced to displace, the other section can continue to cover the assigned sector. To achieve this, sections position themselves so that fires directed at one section do not suppress the other section.

(2) **Overlapping Sectors.** Overlapping the sectors of fire is essential to mutual support. It must be accomplished with primary, secondary, and alternate sectors of fire.

b. **Security.** Antiarmor units are vulnerable to attack by dismounted infantry. To protect antiarmor units, position them near friendly infantry units. Antiarmor squads do not need to be collocated with infantry, but the infantry should be able to cover dismounted avenues of approach to the antiarmor positions. When moving with infantry, antiarmor units provide their own local security.

c. **Flank Engagements.** Antiarmor units should be positioned to engage enemy armored vehicles from the flank. Frontal shots at enemy armor are less desirable because—

- An armored vehicle's protection is greatest in the front.
- An armored vehicle's firepower and crew are normally oriented to the front.
- Frontal engagements increase the chance of detection and suppression.
- Target Identification is more difficult from the front.

d. **Standoff Range.** The TOW in conjunction with the ITAS has an advantage of accuracy over most tanks' main guns at extended ranges (beyond the 2,000-meter range of tanks' main guns). The accuracy of a tank's main gun decreases with increased range while that of an TOW does not. Positioning ITAS to exploit its maximum range decreases vulnerability to detection and return fire. This range advantage, called standoff, is the difference between the tank's maximum effective range and the ITAS maximum range. With its maximum range of 3,750 meters, an ITAS has the standoff advantage against a tank with a maximum effective range of 2,000 meters.

e. **Cover and Concealment.** Cover and concealment are critical to the survivability of antiarmor weapons systems. Cover is protection from the fire of enemy weapons and from enemy observation. It may be natural or man-made. Concealment is protection from observation only. Concealment hides a soldier, vehicle, position, or unit from ground and aerial observers and gunners. It includes not only camouflage but also light, noise, movement, and odor discipline. With recent improvements in night vision and other detection devices, darkness alone no longer constitutes concealment.

f. **Depth.** Antiarmor fire should be employed in depth. In the offense, routes and firing positions should be selected to support the forward movement of attacking units. In the defense, antiarmor positions may be either forward initially and moved to in-depth positions as the enemy closes, or they may be positioned initially in depth.

g. **Combined Arms Team.** Skillful integration of infantry, armor, engineer, and artillery assets will significantly improve the survivability and lethality of antiarmor units.

h. **Aided Target Tracker versus Manual Engagement.** The ITAS affords the gunner the option of choosing an ATT engagement or a manual engagement. An ATT engagement is usually the preferred method because it increases the probability of a hit by minimizing gunner error. It may not be the preferred method in a quick-reaction scenario because track gate adjustment may take longer than the time available.

## 5-2. EMPLOYMENT CAPABILITIES AND LIMITATIONS

The TOW and ITAS have capabilities and limitations that the commander must be aware of to effectively employ the weapon system.

a. **Capabilities.** The TOW is mainly an antitank weapon used for long-range engagement of armored targets. It can be employed in all weather conditions as long as the gunner can see the target through the ITAS. The TOW also provides a long-range assault capability against heavily fortified bunkers, pillboxes, and gun emplacements.

(1) The TOW missile can destroy targets at a minimum range of 65 meters and a maximum range of 3,750 meters. The TOW 2B missile can destroy targets at a minimum range of 200 meters and a maximum range of 3,750 meters.

(2) The automatic missile tracking and control capabilities of the ITAS provide a high first-round-hit probability. To operate the system, the gunner places the track gates on the target, fires the missile, and centers the crosshairs on the target image until missile impact. The optical tracking and command functions within the system guide the missile to the target as long as the gunner keeps the crosshairs on target.

b. **Mobility.** The ITAS can be vehicle-mounted or ground-emplaced (tripod-mounted) for operation. Missiles can be launched from either operational mode. (Detailed operating procedures for each configuration are provided in Chapters 3 and 4.)

(1) The entire system can be carried by a single crew for short distances. Moving it over long distances without the vehicle will require two crews, which causes two systems to be out of operation at the same time.

(2) The vehicle-mounted launcher is more mobile and can be quickly prepared for use. The launcher can be assembled and disassembled without the use of tools.

(3) Built-in self-test circuits can be used to check the operational condition of the assembled launcher, whether ground- or vehicle- mounted.

## Section II. EMPLOYMENT IN OFFENSIVE/DEFENSIVE OPERATIONS

The TOW is the antiarmor weapon system organic to most infantry battalions that provides a heavy antiarmor capability in the offense and defense. This section covers basic antiarmor fundamentals, capabilities, limitations and employment considerations, which must become routine operation as a result of battle-focused training. The ITAS is a battalion level asset that will support companies (depending on their mission) and the armor threat within their area of operation. At times, an ITAS section may support lower echelons such as a rifle platoon. Operational control is assigned at battalion level and is paramount to mission success. It is a command and control requirement that ensures accountability and responsibility. However, leaders should acknowledge the antiarmor section leader's technical and tactical proficiency to ensure that the ITAS and TOW are employed in accordance with current doctrine.

### 5-3. OFFENSIVE OPERATIONS

The TOW contributes to offensive operations by providing long-range fires that destroy enemy armor and protect the force from armored counterattacks. In the absence of armored targets, the TOW can engage enemy fortifications and hovering helicopters. The TOW is normally used in a support-by-fire role during offensive operations. The primary consideration for such employment is the availability of appropriate fields of fire and the armored threat. TOW crews can, however, effectively protect flanks against armored threats and can also provide overwatch for unit movement (Figure 5-1).

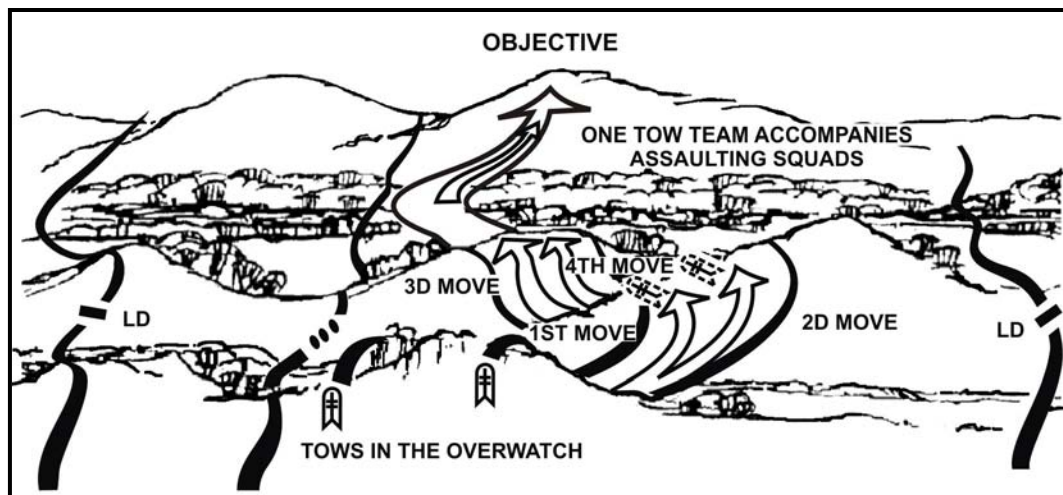


Figure 5-1. TOW supporting offensive operations.

#### 5-4. ANTIARMOR AMBUSH ROLE

Antiarmor ambushes are usually conducted to destroy small groups of armored vehicles, force the enemy to move more slowly and cautiously, or force the enemy into a choke point. Any unit conducting an antiarmor ambush can use the TOW for this purpose. The TOW has a relatively slow rate of fire, so other weapons systems must be prepared to engage the vehicles while the TOW gunners load new rounds. The 3,750-meter range of the TOW missile allows some flexibility in choosing ambush positions. In addition to fires into the kill zones, the TOW can be employed in a security role to guard high-speed avenues of approach, to slow or stop enemy reinforcements, or to destroy vehicles attempting to flee the kill zone (Figure 5-2).

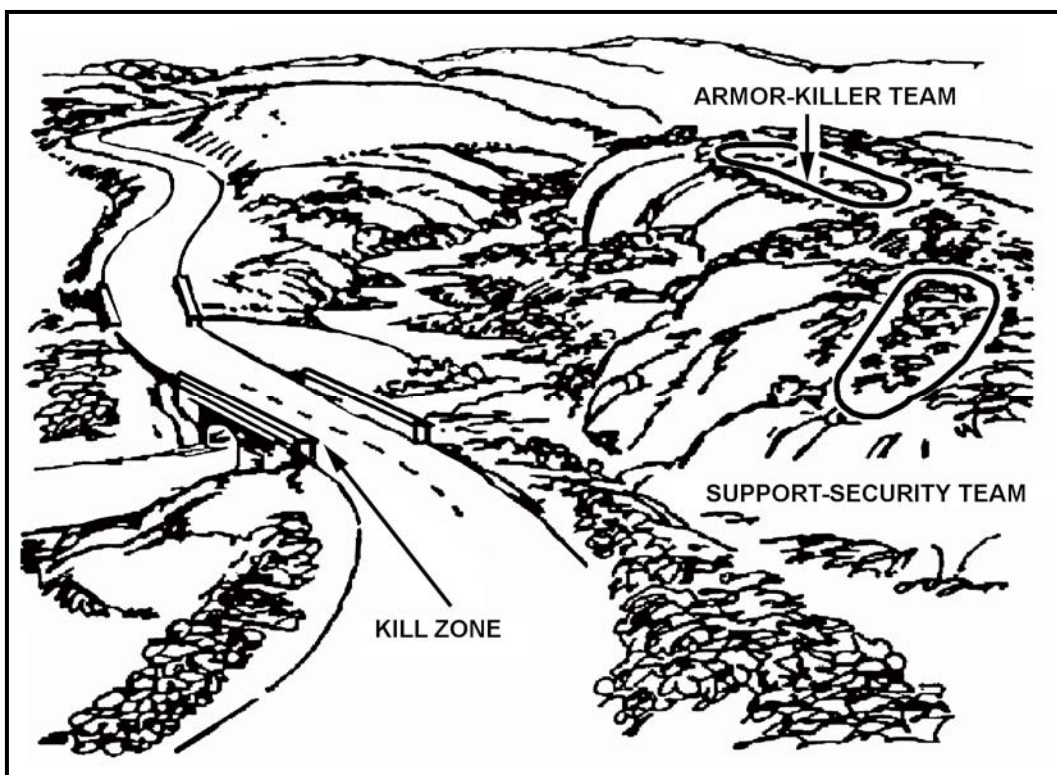


Figure 5-2. Antiarmor ambush.

#### 5-5. DEFENSIVE OPERATIONS

In the defense the antiarmor section leader is responsible for assigning sectors to the ITAS squad. The squad leader chooses the location that can best cover the sector while applying the basic fundamentals of employment. During planning, the leader considers the enemy armor threat, then positions antiarmor weapons accordingly to cover armor avenues of approach. He also considers the fields of fire, tracking time, and minimum engagement distance of each weapon. The section leader or squad leader selects a primary position and sector of fire for each antiarmor weapon. He also picks alternate and supplementary positions for them. Each position should allow flank fire and have cover and concealment. The leader should integrate the ITAS into his limited visibility security



and observation plan. The gunner prepares a range card for his primary position; if time permits, he also prepares them for his alternate and supplementary positions.

a. **Personnel Duties.** The tasks listed below must be performed to successfully employ the ITAS in the defense (Table 5-1).

TASKS TO BE PERFORMED	AA SECTION ----- SECTION SERGEANT	AA SECTION ----- SQUAD LEADER	GUNNER	DRIVER/LOADER
Integrate TOW into the tactical plan: <ul style="list-style-type: none"> <li>• Select general weapons positions.</li> <li>• Assign sectors of fire.</li> <li>• Coordinate mutual support.</li> <li>• Coordinate with adjacent units.</li> </ul>	X			
Reconnoiter for and select tentative firing positions (primary, alternate, and supplementary) and routes between positions.	X	X		
Supervise continual preparation and improvement of positions.	X	X	X	
Coordinate security for the squads.	X			
Inspect the selection of tentative firing positions and confirm or make adjustments.	X	X	X	
Supervise preparation of antiarmor range card.	X	X		
Control movement of crews between positions.	X	X		
Issue fire command to gunners.	X	X		
Coordinate resupply.	X			
Identify enemy avenues of approach.	X			
Prepare fighting positions (primary alternate and supplementary).		X	X	X
Prepare antiarmor range card.			X	
Designate target reference points.	X			
Prepare rounds for firing.				X
React to fire commands.			X	
Engage targets.			X	

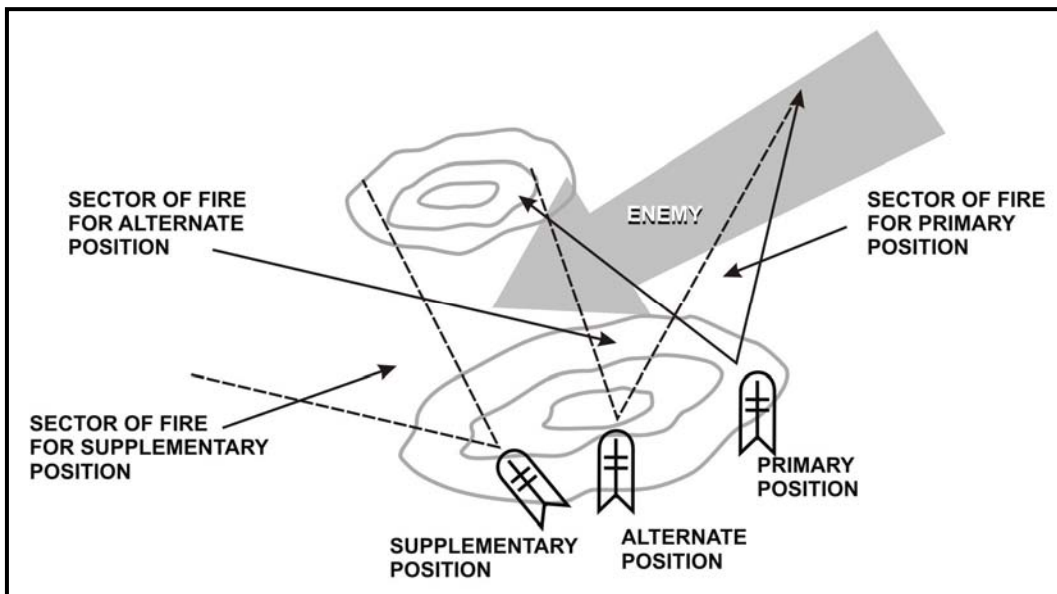
**Table 5-1. Personnel duties.**

b. **ITAS Placement.** The squad leader selects the fighting position and assigns the sector of fire. Considering the fundamentals of antiarmor employment will greatly improve the crew's survivability.

(1) **Integrate with Adjacent Units.** ITAS crews must coordinate with adjacent units to ensure security.

(2) **Engage at Maximum Range.** The TOW's 3,750-meter maximum range makes it difficult for the enemy to engage the crew with direct fire, which forces the enemy to deploy earlier than intended.

c. **Positions.** The three types of firing positions are primary, alternate, and supplementary (Figure 5-3).



**Figure 5-3. Primary, alternate, and supplementary firing positions.**

(1) **Primary.** The primary position is one from which a gunner or team can cover the assigned sector of fire. It should have good observation, cover and concealment, and good fields of fire.

(2) **Alternate.** The alternate position is one from which a gunner or crew can either move to the flank or slightly to the rear of the primary position. The gunner or crew must be able to cover the same sector of fire as from the primary position. The gunner moves to the alternate position when the primary position can no longer be occupied. The decision to change positions is made by the leader.

(3) **Supplementary.** The supplementary position is one from which a gunner or crew covers avenues of approach and any TRPs not covered by the primary and alternate positions. This position is usually close enough to the primary position to share mutual support with other positions. This position should also have good observation, cover and concealment, and good fields of fire.

## 5-6. OTHER TACTICAL OPERATIONS

Other tactical operations the ITAS may be employed in include stability and support and urban operations.

a. **Stability and Support Operations.** During stability operations, ITAS crews may be used against an armored threat if one exists. If no armored threat exists, the ITAS crew can provide an enhanced surveillance capability. In the case of roadblocks, TOW crew can provide protection against vehicles that attempt to run the roadblock. To be effective in this task, the crew must be able to position itself where they have an unimpeded view of the approaches to the roadblock. The gunner must clearly understand the rules of engagement (ROE) to know when he is authorized to engage targets, which may be at minimum range. The observation capability of the ITAS may be useful during support operations, but it is not likely that a missile will ever be fired.

b. **Urban Operations.** The TOW is primarily used to defeat main battle tanks and other armored combat vehicles. It has a moderate capability against bunkers, buildings, and other fortified targets commonly found during combat in built-up areas; therefore, the TOW may not be the weapon of choice in the urban environment (FM 3-06.11 [FM 90-10-1]).

(1) TOW crews provide overwatching antitank fires during the attack of a built-up area. Within built-up areas, they are best employed along major thoroughfares to attain adequate fields of fire. The minimum engagement distance limits firing opportunities in the confines of densely built-up areas.

(2) Additional considerations include fires, caused by both friendly and enemy, that may cause target acquisition and lock-on problems and clutter on the battlefield, which may cause lock-on problems.

## 5-7. ENGAGEMENT CONSIDERATIONS

Engagement considerations for the TOW include engagement distance, crossover, backblast, weapon penetration, and breaching structural walls. TOW systems should always seek to engage at maximum range. If within 1,000 meters of an enemy, the flight time of the TOW missile would likely be greater than the flight time of a main gun tank round.

a. **Engagement Distance.** The TOW has a minimum range of 65 meters and a maximum range of 3,750 meters. The TOW 2B has a minimum range of 200 meters and a maximum range of 3,750, which limits its use in built-up areas. Few areas in the inner city permit the gunner to fire much beyond the minimum arming distance. The gunner is usually limited to firing down streets, rail lines, parks, or plazas.

b. **Crossover.** At times, the ATT will not be able to distinguish between the background and the target because the two will have the same temperature (crossover). In this situation, the gunner can use manual engagement to engage targets, if visibility permits.

c. **Breaching Structural Walls.** The TOW is not effective when breaching structural walls. The antitank guided missiles (ATGMs) are not designed to breach structural walls effectively.

### Section III. FIGHTING POSITIONS

TOW fighting positions may be mounted or dismounted, depending on the situation. A camouflage net can be used with either configuration.

#### 5-8. DISMOUNTED TOW FIGHTING POSITION

A dismounted (tripod-mounted) TOW fighting position must meet the following specifications:

- Allows the squad to engage the enemy in its assigned sector of fire.
  - Provides protection for both the weapon and its crew.
  - Blends with its surroundings so that it cannot easily be detected 35 meters to the front and cannot be seen from the air.
- a. The position should be constructed sequentially as follows:
- (1) Assemble the launcher.
  - (2) Clear the fields of fire while ensuring the sector is under observation.
  - (3) Dig the weapon position first, then add overhead protection for the crew.
  - (4) Build a parapet to the front and flanks of the position.
  - (5) Disconnect the MGS and place it in the position made for it. Place the launcher into the position. Reconnect the MGS and check the boresight.
  - (6) Improve the position by adding overhead cover for the crew and system.
  - (7) Camouflage the position.
  - (8) Inspect the position and its camouflage. If possible, move at least 35 meters to the front of the position and study it.
- b. The initial position should look like the position in Figure 5-4.

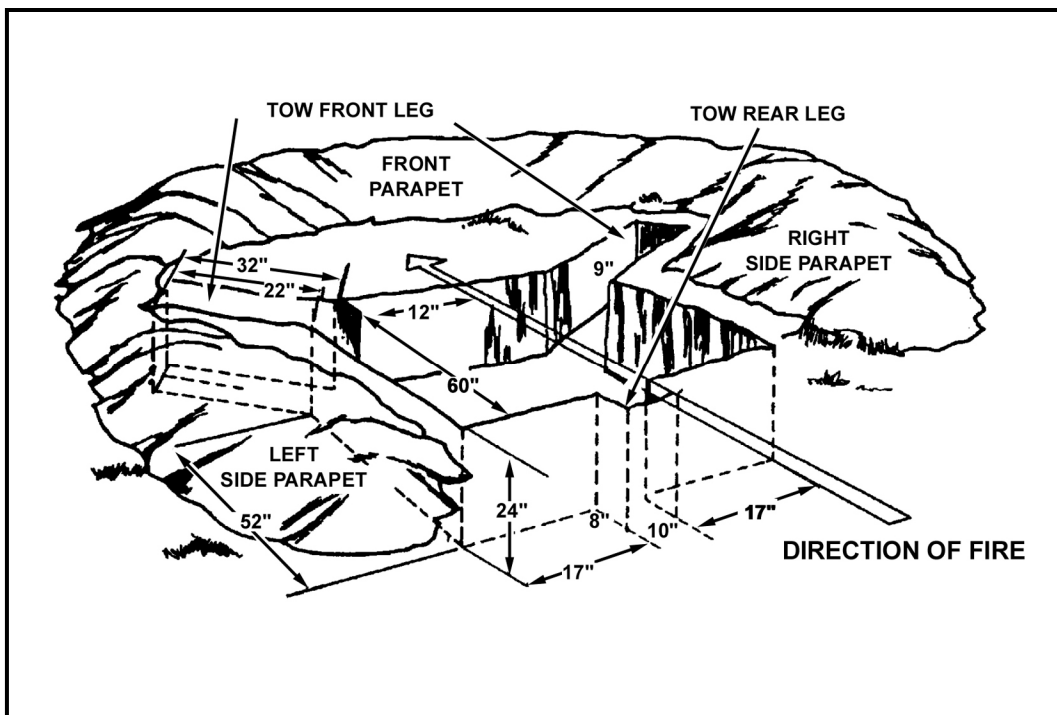
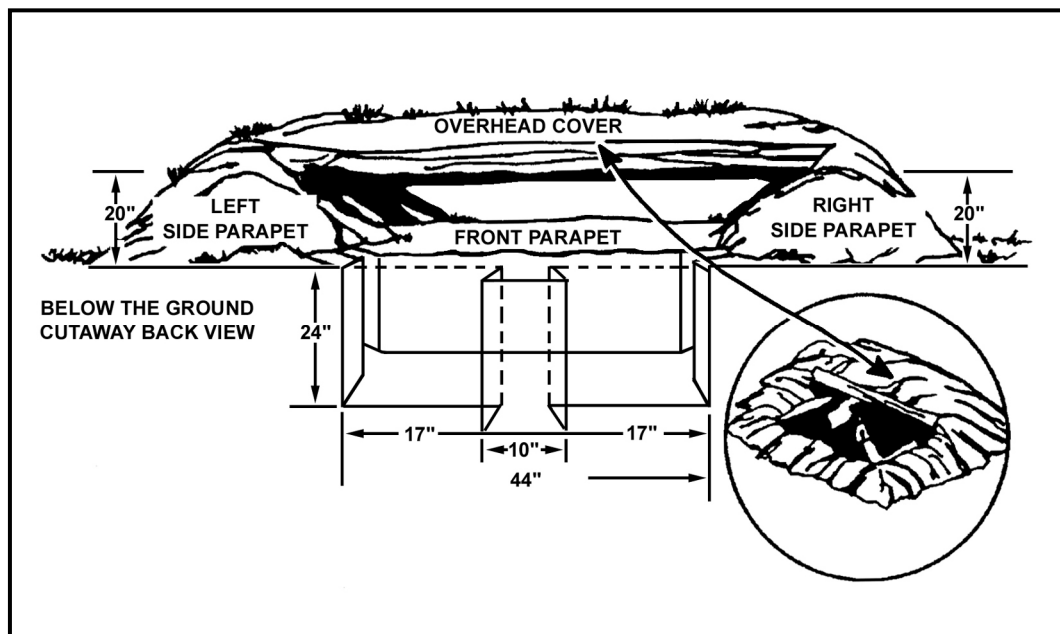


Figure 5-4. Tripod-mounted TOW fighting position.

- (1) Make the position 24 inches deep.
- (2) Make the parapet at least 18 inches thick to keep out small-arms fire and artillery fragments. It should provide 9 inches of muzzle clearance under the launch tube.
- (3) Do not place dirt or equipment in the backblast area.
- (4) Scoop out a place for the MGS either under or to the front of the tripod.
- (5) Dig a storage/protective area for the crew and missiles to one flank at a 90-degree angle to the primary direction of fire. Use the strongest material available for the roof. Put canvas or plastic down before throwing dirt on the roof to keep the ceiling from leaking. Place at least 20 inches of dirt on top of the storage/protective area (Figure 5-5)



**Figure 5-5. Storage/protective area.**

- (6) Ensure the ground behind the TOW is free of leaves and dirt out to 25 meters so the backblast does not leave a signature.
- (7) Ensure all the standard principles of camouflage are followed. (For example, cover all fresh dirt with leaves and brush, replace withered foliage, always approach position from rear, and so forth.)

### **5-9. MOUNTED TOW FIGHTING POSITION**

A mounted TOW fighting position must meet the following specifications:

- Does not restrict the TOW's target engagement.
- Provides concealment from ground and air observation for the crew and vehicle.
- Backblast area is as clear as possible of debris that would increase launch signature.

a. Camouflage and conceal the firing position.

- (1) All vehicles travel to a position over the same route to prevent the enemy from detecting the number of vehicles present.

(2) The route taken should follow existing paths, roads, fences, or natural lines in terrain.

(3) Exposed routes should not end at a position.

(4) If only a short portion of the route into a position is exposed, sweep out the tracks with tree branches.

(5) Traffic in and out of a position should be held to essential movements only.

(6) Upon moving into a position, be sure to erase the trail leading into it.

(7) Ensure all standard principles of camouflage are adhered to (same as for tripod-mounted position).

b. If a hull-down position is not available, use a hide position (Figure 5-6).

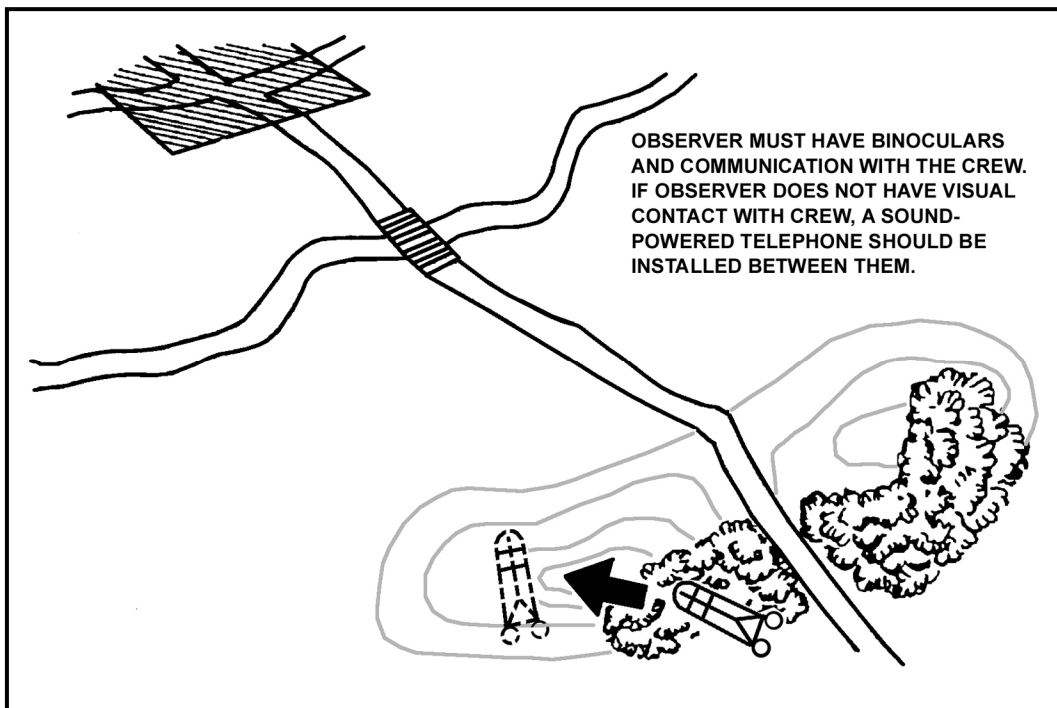


Figure 5-6. TOW hide position.

c. If possible, move at least 35 meters in front of the position to ensure that it looks natural and blends with its surroundings.

### 5-10. CAMOUFLAGE NETS

When camouflaging any TOW fighting position, whether mounted or dismounted, the net must be positioned so it does not hang in the backblast area. If any portion of the net is in the backblast area, the net will be damaged and could collapse on top of the launcher when a missile is launched. Also, the net must not interfere with the field of fire.

## Chapter 6

# TRAINING PROGRAM

*The ITAS training program integrates the ITAS into the overall unit training program to increase combat readiness and ensure trainers and gunners are proficient in operating and maintaining the ITAS. The strategy is a multiechelon, device-based program that allows the unit to train at individual, crew, platoon, and company levels. The foundation of this training program is obtaining and sustaining individual basic skills through a train-the-trainer concept with collective training as the capstone to ensure these skills are battle-focused to support the unit's mission-essential task list (METL). The recommended training plan incorporates current doctrine, technology, and guidance to prepare the ITAS gunner, crew, and unit to survive and win.*

### 6-1. TRAINING STRATEGY

The commander must know the current status of ITAS training in the unit. He conducts an assessment to determine the initial and sustainment training required to maintain the proficiency of the ITAS crews. The commander is responsible for providing guidelines on training ITAS crews. The unit's training program is based on the unit's METL, battle focus, and the supporting individual, leader, and collective tasks. The ITAS training strategy is composed of five primary components:

- Initial training.
- Sustainment training.
- Collective training.
- Force-on-force training.
- Leader training.

a. **Initial Training.** Initial gunner training is conducted at the institution during the one-station unit training (OSUT) program of instruction (POI). All infantry OSUT soldiers attend familiarization training on antiarmor weapons, which consists of a period of instruction designed as an overview of the TOW weapon system. Initial gunner training is conducted in the unit for soldiers assigned to ITAS crews. Trainers will use the guidelines prescribed in this chapter to train their crewmembers, culminating in the successful completion of the GST.

b. **Sustainment Training.** Sustainment training ensures soldiers retain skills learned during initial training. This training takes place entirely in the unit monthly, bimonthly, quarterly, and annually.

(1) Gunners retain their skills by practicing target engagement at least monthly, firing 10 out of 20 missions from the monthly sustainment exercises using the BST. Gunners practices field engagements using the FTT every quarter. Once each quarter, the gunner completes the entire GST. If the gunner does not perform satisfactorily, he retrain and retests until he does.

(2) As individual ITAS crewmen, squads, sections, and platoons become qualified, the commander maintains that status by sustainment training and evaluation, and by crew stabilization. While personnel changes are inevitable, changes within squads should

ensure maximum stability for the longest periods of time in units. Personnel changes should be examined in detail to ensure crew integrity and combat readiness.

c. **Collective Training.** Collective training is the coordinated performance of individual skills and tasks as a team. Collective tasks are normally performed by more than one soldier. Collective training takes place in the unit to integrate the ITAS into the unit's overall combat power using the FTT.

(1) Common crew task training is the first level of collective training. Common crew tasks provide the basic technical collective tasks performed by the crew to accomplish the wartime mission. These tasks tell "how to" and allow each soldier in the crew to perform his tasks. As a result, the squad leader, gunner, driver, and loader combine their learned individual technical skills to perform as one crew on their assigned vehicle.

(2) The critical squad and platoon collective tasks are called battle drills. Battle drills are mostly independent of METT-TC and require minimal leader actions to execute. They are standardized throughout the U.S. Army. Battle drills are found in the applicable drill book for each echelon and equipment-type unit. The battle drills for antiarmor platoons are found in ARTEP 7-91-Drill.

(3) Common crew tasks are tasks performed by an ITAS crew that are not battle drills but are performed in the same manner. An example of a common crew task is Dismount/Remount the ITAS. Crew tasks are crucial to applying tactics to enhance survival and to accomplish the ITAS crew's mission of providing antiarmor direct fire support to destroy the enemy.

(4) Collectively, common crew tasks and battle drills form each action the crew must perform. For example, this manual discusses the common crew tasks to mount, stow, dismount, and engage a target with an M41 ITAS TOW missile launcher mounted on an M1121 HMMWV.

(5) ARTEP training exercises are used to practice, evaluate, and sustain collective tasks and mission proficiency. They have specific goals and are modified based on METT-TC factors. Exercises are structured to the availability of resources, time, and training areas. (See appropriate ARTEP7-91-MTP for details on planning and conducting an ARTEP exercise.)

d. **Force-On-Force Training.** Force-on-force training is conducted with the FTT during squad, platoon, company, and FTX/STX. It helps sustain proficiency on the proper ways to scan for and engage targets using the ITAS in a tactical environment.

e. **Leader Training.** Leaders are taught to train, maintain, and employ the ITAS in courses such as OES and NCOES. The training must continue in units formally through NCO and officer professional development classes and informally through personal initiative. Leader training is conducted in both the institution and the unit.

(1) ITAS leader training begins with the basic understanding of the ITAS, its capabilities and limitations; then moves to understanding the fundamentals of ITAS tactical employment; and includes how to integrate the ITAS into company-level training.

(2) Leaders must learn and then practice how to employ and integrate ITAS into their units. Using TEWT is an effective way to develop the leader's tactical understanding. Employing gunners with their squads helps train other squad or fire team members to perform their duties (providing security, locating targets, and so on). After-action reviews must be conducted after all training exercises so ITAS security, operation, and



employment considerations can be more effectively integrated into the unit-training plan. (For more information on tactical employment see FM 3-21.91[FM 7-91]).

## **6-2. COMMANDER'S TRAINING ASSESMENT AND PLANNING**

All mandatory ITAS gunnery training and testing is included in the 12 ITAS gunnery exercises plus the quarterly GST. However, the commander must still conduct an accurate assessment of the state of ITAS training in his unit to determine the additional training necessary to prepare the unit for the quarterly and semiannual exercises. **The commander must remember that the unit must meet the standards outlined in DA Pam 350-38 to be certified in the training status C1, fully trained.** An accurate assessment of training requirements and thorough planning produce an effective unit training program. The commander should start early, be thorough, and be flexible and creative. All aspects of the training program should be coordinated to produce the desired results.

a. The commander should refer to FM 7-1, when developing his unit training program. This FM applies the doctrine established in FM 22-100, and assists leaders in the development and execution of training programs.

b. The heart of an effective training program is the development of a METL and the soldier tasks, leader tasks, and collective tasks that support the METL. Battle focus drives the METL development process; the METL is based on the wartime mission, and the unit must train as it plans to fight. FM 7-1 illustrates this process in clear and practical terms.

c. Once the commander has developed the unit METL and referenced the appropriate field manuals, he must look at the training strategy to ensure that it is incorporated as part of the total Army ITAS training strategy.

## **6-3. TRAINING DEVICES**

The ITAS/TOW system includes three training devices: the BST, the FTT, and the MSR. Use the three training devices in combination to produce a highly skilled ITAS gunner.

a. **Basic Skills Trainer.** The ITAS BST is the primary training device for initial, sustainment, practice, and qualification of individual gunner skills for the ITAS (Figure 6-1, page 6-4). It simulates most tactical scenarios and system malfunctions that ITAS gunners may encounter on the modern battlefield. The ITAS BST consists of two major components: a portable personal computer called the instructor station and a student station. The ITAS BST introduces new soldiers to the actual ITAS controls, handgrips, and system responses by connecting directly to the tactical system TU and accurately simulating all system functions including on-screen menus, laser ranging, and missile flight. The BST helps more advanced soldiers master system operation through progressive levels of training requiring a better understanding of all target engagement procedures including target detection, classification, recognition and identification; ATT operation; and manual tracking.

**CAUTION**

The BST is a computer and can be damaged or destroyed if treated roughly. Do not expose the BST to dirt, extreme humidity, or extreme temperature changes.



**Figure 6-1. Basic skills trainer.**

(1) **Instructor Station.** The instructor station equipment centers around a desktop personal computer (PC) that provides the means to install or upgrade software, create and save gunner training records, and monitor gunner performance during an exercise. It is controlled by point-and-click mouse commands with a means for entering and saving gunner training record data on a 3.5-inch disk. The instructor station allows the instructor to monitor the gunner's actions during the exercise. After the exercise is over, the monitor can be used to critique the gunner's performance by replaying the exercise.

(2) **Student Station.** The student station consists of a simulated tactical acquisition system (STAS) and a simulated fire control system (SFCS) used in conjunction with the tactical TU and tripod. It reproduces simulated battlefield imagery—visual indicators the

gunner uses during target engagement—and operational sounds from a built-in speaker system.

(3) **Training Exercises.** The BST contains training exercises for initial ITAS training and qualification with two retests for each qualification exercise. The initial training and qualification exercises are stored in separate directories with additional directories for sustainment and advanced gunnery training. Exercises contain terrain models, three-dimensional target models, weather conditions (rain, snow, fog, and so forth), and malfunctions (hangfire, misfire, and so forth). Exercise run times are from one to seven minutes long.

(4) **Simulated Imagery.** The computer-generated infrared and daylight imagery reflects the magnification and spectral capabilities of the ITAS. The BST training exercises use digital images of real terrain from actual visible light and infrared imagery. As the gunner works through an exercise, identical imagery is displayed on the instructor station.

b. **Field Tactical Trainer.** The FTT is a fully integrated, three-dimensional force-on-force training device. It combines the TAS with a simulated round, which incorporates a MILES laser transmitter to allow simulated ITAS engagements during training exercises. The FTT simulates the operation and engagement parameters of the ITAS (Figure 6-2).



Figure 6-2. Field tactical trainer.

#### 6-4. TRAINING SUPPORT PACKAGES AND RESOURCES

Appropriate manuals will provide information received from courses, such as the AntiArmor Leaders Course, and hands-on experience with the system. (These manuals have not yet been published.)

- TOW Improved Target Acquisition System (ITAS) Basic Skills Trainer (BST) Operator Maintenance Manual.
- TOW Improved Target Acquisition System (ITAS) Basic Skills Trainer (BST) Instructor Guide.
- TOW ITAS Gunner, New Equipment Training, Student Guide.
- TOW ITAS Gunner, New Equipment Training, Instructor Guide.
- Technical Manual, Operator and Organizational Maintenance Manual for TOW Improved Target Acquisition System (ITAS) M41, TM 9-1425-923-12.
- Instructor Certification Program.

#### 6-5. ITAS GUNNERY TRAINING

The ITAS gunnery training program is divided into four phases: individual gunnery, squad gunnery, section gunnery, and platoon gunnery. Phase I (individual gunnery) consists of the GST and ITAS Gunnery Exercises 1 through 4. Phase II (squad gunnery) consists of ITAS Gunnery Exercises 5 through 8. Phase III (section gunnery) consists of ITAS Gunnery Exercises 9 and 10. Phase IV (platoon gunnery) consists of ITAS Gunnery Exercises 11 and 12. (Blank forms for scoring all gunnery phases are located in the back of this manual for local reproduction.)

**NOTE:** The second quarterly GST should be conducted at least seven days prior to conducting ITAS Gunnery Exercises 7 through 12.

a. **Phase I—Individual Training.** Phase I consists of sustainment training with the BST and the tasks evaluated during the GST. It is conducted on a monthly basis to maintain proficiency.

- Gunner Skills Test. Use DA Form 7540-R (Gunner's Skill Test (ITAS)) to score the Gunner's Skill Test (Figure 6-3 shows an example of a completed DA Form 7540-R).
- ITAS Gunnery Exercise 1, Individual Gunnery Practice.
- ITAS Gunnery Exercise 2, Individual Gunnery Sustainment.
- ITAS Gunnery Exercise 3, Individual Gunnery Qualification.
- ITAS Gunnery Exercise 4, Individual Gunnery Qualification Retest.

GUNNER'S SKILL TEST (ITAS)			
For use of this form, see FM 3-22.32; the proponent agency is TRADOC.			
NAME:	RANK:	UNIT:	DATE:
THOMPSON, GARY B.	SGT	C 2/22 IN	14 APR 04
TASK NUMBER	TASK TITLE	GO	NO GO
1.	ASSEMBLE AN M41 ITAS	X J.H.	
2.	MAINTAIN AN M41 ITAS	X T.M.	
3.	PERFORM PREOPERATIONAL INSPECTION ON AN M41 ITAS AND ENCASED MISSILE	X T.M.	
4.	PERFORM GRIPS TEST AND I-BIT FOR AN M41 ITAS	X T.M.	
5.	DESCRIBE AND USE OPERATOR'S CONTROLS AND INDICATORS OF THE BATTERY POWER SOURCE (BPS)	X B.L.G.	
6.	BORESIGHT AN M41 ITAS	X M.K.	
7.	LOAD AN M41 ITAS	X M.K.	
8.	UNLOAD AN M41 ITAS	X M.K.	
9.	DETERMINE FIRING LIMITATIONS FOR M41 ITAS	X H.R.	
10.	IDENTIFY COMBAT VEHICLES	X H.R.	
11.	DETERMINE IF A TARGET IS IN RANGE (ACTIVE/PASSIVE RANGING)	X B.A.	
12.	DETERMINE IF AN IN-RANGE TARGET IS ENGAGEABLE USING AN M41 ITAS	X P.R.	
13.	ENGAGE TARGETS WITH AN M41 ITAS	X P.R.	
14.	PERFORM IMMEDIATE ACTION PROCEDURES FOR M41 ITAS MALFUNCTION		X J.H.T
15.	MOUNT THE M41 ITAS ON THE M1121 CARRIER IN THE READY-TO-FIRE CONFIGURATION	X E.W.	
16.	PREPARE THE M41 ITAS IN THE DISMOUNTED READY-TO-FIRE CONFIGURATION	X E.W.	
17.	PREPARE AN ANTIARMOR RANGE CARD	X S.T.	

DA FORM 7540-R, JAN 2005

APD V1.00

Figure 6-3. Example completed DA Form 7540-R.

b. **Phase II—Squad Training.** Phase II consists of refresher training on the set up and operation of FTT or MILES equipment, as necessary, in preparation for ITAS Gunnery Exercises 5 and 6 and sustainment training, as necessary, to prepare for ITAS Gunnery Exercises 7 and 8.

- ITAS Gunnery Exercise 5, Baseline Gunnery Practice. Use DA Form 7541-R (ITAS Gunnery Exercise 5 and 6: Baseline FTT Gunnery) to score exercises 5 and 6. (Figure 6-4 shows an example of a completed DA Form 7541-R.)
- ITAS Gunnery Exercise 6, Baseline Gunnery Qualification.
- ITAS Exercise 7, Squad Gunnery Practice (in preparation for Exercise 8). Use DA Form 7542-R (ITAS Gunnery Exercise 7: Squad Gunnery Practice FTT) to score exercise 7. (Figure 6-5, shows an example of a completed DA Form 7542-R.)
- ITAS Gunnery Exercise 8, Squad Gunnery Qualification. Use DA Form 7543-R (ITAS Gunnery Exercise 8: Squad Gunnery Qualification FTT) to score exercise 8. (Figure 6-6, page 6-10, shows an example of a completed DA Form 7543-R.)

ITAS GUNNERY EXERCISE 5 AND 6: BASELINE FTT GUNNERY					
For use of this form, see FM 3-22.32; the proponent agency is TRADOC.					
<input type="checkbox"/> PRACTICE		<input type="checkbox"/> QUALIFICATION			
SQUAD:	SECTION:	PLATOON:	COMPANY:		
1ST	1ST	1ST	C 3/10 IN		
DATE:		TIME:	CHECK ONE		
2 MAY 04		1045	<input checked="" type="checkbox"/> DAY <input type="checkbox"/> NIGHT		
ENGAGEMENT	TARGET DISCRPTION	HIT / MISS / TIME	GO	NO GO	
TARGET 1	STATIONARY TANK / FLANK / 1,000 - 1,500 METERS ± 200M	HIT TIME: 21 SEC.	MISS	X	
TARGET 2	STATIONARY TANK / FLANK / 2,100 - 3,750 METERS ± 200M	HIT TIME: 25 SEC.	MISS	X	
TARGET 3	STATIONARY TANK / FRONTAL / 2,100 - 3,750 METERS ± 200M	HIT TIME: 23 SEC.	MISS	X	
TARGET 4	STATIONARY TANK / DEFLADE / 2,100 - 3,750 METERS ± 200M	HIT TIME: 24 SEC.	MISS	X	
TARGET 5	STATIONARY TANK / FLANK / 800 - 1,500 METERS ± 200M	HIT TIME: 21 SEC.	MISS		X
TARGET 6	MOVING TANK / FLANK / L-R, 30 KPH 1,600 - 2,000 METERS ± 200M / NBC	HIT TIME: 23 SEC.	MISS	X	
TARGET 7	MOVING TANK / FLANK / L-R, 30 KPH 1,600 - 2,000 METERS ± 200M / NBC	HIT TIME: 20 SEC.	MISS	X	
TARGET 8	MOVING TANK / FLANK / L-R, 5 KPH 1,000 - 1,500 METERS ± 200M	HIT TIME: 27 SEC.	MISS	X	
TARGET 9	MOVING TANK / FLANK / L-R, 10 KPH 2,100 - 3,750 METERS ± 200M	HIT TIME: 26 SEC.	MISS	X	
TARGET 10	MOVING TANK / FLANK / L-R, 40 KPH 1,600 - 2,000 METERS ± 200M	HIT TIME: 23 SEC.	MISS	X	
IN ORDER TO RECEIVE A GO ON ANY TARGET ENGAGEMENT, THE GUNNER MUST HIT THE TARGET WITHIN 30 SECONDS AFTER THE TARGET IS EXPOSED. TO RECEIVE A GO ON EXERCISE 5, THE CREW MUST RECEIVE A GO ON "INSTALL THE FTT" AND A GO ON AT LEAST 8 OUT OF 10 TARGET ENGAGEMENTS, BOTH DAY AND NIGHT.			OVERALL GO / NO GO:	9	

Figure 6-4. Example completed DA Form 7541-R.

ITAS GUNNERY EXERCISE 7: SQUAD GUNNERY PRACTICE FTT									
For use of this form, see FM 3-22.32; the proponent agency is TRADOC.									
TC: <u>SSG MARK</u>	LDR: _____	GNR: <u>SPC DAY</u>	OVR: <u>SPC BROWN</u>	DATE: <u>5 AUG 04</u>	TIME: <u>1645</u>	CHECK ONE <input type="checkbox"/> DAY <input type="checkbox"/> NIGHT		BATTALION: <u>2/21 IN</u>	
PLATOON: <u>2ND</u>		COMPANY: <u>B</u>		TOTAL SCORE: <u>344</u>					
TASK	CONDITIONS/TARGETS/SITUATION	TOTAL TARGET EXPOSURE TIME	HITS	ENGAGEMENT TIMES	POINTS	CREW/LOR CUTS	TOTAL POINTS		
1. ENGAGE A SINGLE TARGET	FIRED FROM BASELINE. 3,000 - 3,750 METERS ± 200M 1 STATIONARY TANK	25 SECONDS	①	ST TK -17	92		92		
2. ENGAGE MULTIPLE TARGETS	FIRED FROM PHASE LINE 2. 2,000 - 2,500 METERS ± 200M 1-ST TANK, 1 MV TANK, 1 MV BMP	2MIN : 30SEC	② ② ②	ST TK -18 MV TK -40 ST BMP-35	80 83 24		64		
3. ENGAGE MULTIPLE TARGETS	FIRED FROM PHASE LINE 3. 2,500 - 3,000 METERS ± 200 M 1-MV TANK, 1-ST BMP	1MIN : 40SEC	③	MV TKO -0	0	-5 EMPLOYER FIRE DISBURSED	38		
4. ENGAGE MULTIPLE TARGETS	FIRED FROM PHASE LINE 2. 2,500 - 3,000 METERS ± 200 M 1-ST TANK, 1-MV TANK (NBC)	1MIN : 40SEC	① ②	ST TK-18 MV TK-34	86 94		90		
5. ENGAGE MULTIPLE TARGETS	FIRED FROM BASELINE. 2,500 - 3,000 METERS ± 200 M 1-MV TANK, 1-MV BMP (NBC)	1MIN : 40SEC	① ②	MV TK-34 MV BMP-18	94 80	-30 BE IN MOPP4	60		

NOTES:

- ENGAGEMENT TIMES ARE CALCULATED FROM THE TIME THE TARGET IS EXPOSED TO THE TIME THE TARGET IS HIT. USE THE LIVE FIRE POINT CALCULATION SHEET FOR SECOND AND THIRD ENGAGEMENTS FROM THE SAME POSITION. THE TIME IS STARTED WHEN THE VEHICLE REOCCUPIES ITS FIRING POSITION (STOPS MOVING) AND ENDS WHEN THE TARGET IS HIT.
- EACH TASK IS WORTH 100 POINTS. EACH TARGET IS ALSO WORTH 100 POINTS FOR TASKS WITH MULTIPLE ENGAGEMENTS. TOTAL THE NUMBER OF POINTS AND DIVIDE BY THE NUMBER OF TARGETS PRESENTED.
- CREW CUTS: SEE FM 3-22.32, CHAPTER 6.
- SCORING EXERCISE 7: EXERCISE 7 IS PERFORMED TWICE, ONCE DURING THE DAY AND ONCE AT NIGHT. EACH EVENT IS WORTH A MAXIMUM OF 500 POINTS.

AFD VI 00

DA FORM 7542-R, JAN 2005

Figure 6-5. Example completed DA Form 7542-R.

ITAS GUNNERY EXERCISE 8: SQUAD GUNNERY QUALIFICATION FTI									
For use of this form, see FM 3-22.32; the proponent agency is TRADOC.									
TC: <u>SSG BLUE</u>	LOR: <u>1ST</u>	GNR: <u>SFC COOKS</u>	DVR: <u>DEG ASHLEY</u>	DATE: <u>6 AUG 04</u>	TIME: <u>1945</u>	CHECK ONE <input type="checkbox"/> DAY <input type="checkbox"/> NIGHT		BATTALION: <u>1/502 IN</u>	
PLATOON: <u>1ST</u>		COMPANY: <u>D</u>							
TASK	CONDITIONS/TARGETS/SITUATION	TOTAL TARGET EXPOSURE TIME	HITS	ENGAGEMENT TIMES	POINTS	CREW/LOR CUTS	TOTAL POINTS		
1. ENGAGE A SINGLE TARGET	FIRE FROM BASELINE. 1,500 - 2,000 METERS ± 200M 1 STATIONARY TANK	25 SECONDS	①	ST TK - 20	74		74		
2. ENGAGE MULTIPLE TARGETS	FIRE FROM PHASE LINE 1. 2,000 - 2,500 METERS ± 200M 1 MV TANK, 1 ST BMP	1MIN - 40SEC	① ②	MV TK - 34 ST BMP - 18	94 86		90		
3. ENGAGE MULTIPLE TARGETS	FIRE FROM PHASE LINE 2. 3,000 - 3,750 METERS ± 200 M 2 MV TANK, 1 ST BMP	2MIN - 45SEC	① ② 3	MV TK - 30 MV TK - 25 ST BMP - 0	96 98 0	-5 EMERGENCY FIRE COMMAND	60		
4. ENGAGE MULTIPLE TARGETS	FIRE FROM PHASE LINE 1. 1,500 - 2,000 METERS ± 200 M 1 ST TANK, 1 MV BMP (NBC)	1MIN - 40SEC	① ②	ST TK - 20 MV BMP - 19	74 84		79		
5. ENGAGE MULTIPLE TARGETS	FIRE FROM BASELINE 2,500 - 3,000 METERS ± 200 M 1 MV TANK, 1 MV BMP (NBC)	1MIN - 40SEC	① ②	MV TK - 34 MV BMP - 18	94 86	-5 EMERGENCY FIRE COMMAND	85	TOTAL SCORE: <u>388</u>	
NOTES:									
1. ENGAGEMENT TIMES ARE CALCULATED FROM THE TIME THE TARGET IS EXPOSED TO THE TIME THE TARGET IS HIT. USE THE LIVE FIRE POINT CALCULATION SHEET FOR SECOND AND THIRD ENGAGEMENTS FROM THE SAME POSITION. THE TIME IS STARTED WHEN THE VEHICLE REOCCUPIES ITS FIRING POSITION (STOPS MOVING) AND ENDS WHEN THE TARGET IS HIT.									
2. EXERCISE 8, UNLIKE EXERCISE 7, IS FOR QUALIFICATION. THE SQUAD IS RATED ON ITS FINAL SCORE, RATHER THAN SIMPLY HAVING TO MEET A MINIMUM STANDARD.									
3. SCORING EXERCISE 8: EXERCISE 8 IS PERFORMED TWICE, ONCE DURING THE DAY AND ONCE AT NIGHT. EACH EVENT IS WORTH A MAXIMUM OF 500 POINTS.									
<input type="checkbox"/> DISTINGUISHED: 900 - 1,000 POINTS		<input type="checkbox"/> SUPERIOR: 800 - 899 POINTS		<input type="checkbox"/> QUALIFIED: 700 - 799 POINTS		<input type="checkbox"/> UNQUALIFIED: 0 - 699 POINTS			
DA FORM 7543-R, JAN 2005									

Figure 6-6. Example completed DA Form 7543-R.



c. **Phase III—Section Training.** Phase III consists of sustainment training, as necessary, to prepare for ITAS Gunnery Exercises 9 and 10.

- ITAS Gunnery Exercise 9, Section Gunnery Practice (in preparation for Exercise 10). Use DA Form 7544-R (ITAS Gunnery Exercise 9: Section Gunnery Practice FTT) to score exercise 9. (Figure 6-7 shows an example of a completed DA Form 7544-R.)
- ITAS Gunnery Exercise 10, Section Gunnery Qualification. Use DA Form 7545-R (ITAS Gunnery Exercise 10: Section Gunnery Qualification FTT) to score exercise 9. (Figure 6-8, page 6-12, shows an example of a completed DA Form 7545-R.)

ITAS GUNNERY EXERCISE 9: SECTION GUNNERY PRACTICE FTT									
For use of this form, see FM 3-22.32; the proponent agency is TRADOC.									
SECTION	TC: <u>SSA MILLER</u>	LDR:	GNR: <u>SFC CANNERS</u>	DVR: <u>PLC BAKER</u>	DATE:	TIME:	CHECK ONE		
SQUAD	TC: <u>SFT QUEEN</u>	LDR:	GNR: <u>PLV MARVEL</u>	DVR: <u>PLC WILSON</u>	<u>15 AUG 04</u>	<u>0900</u>	<input type="checkbox"/> DAY	<input type="checkbox"/> NIGHT	
PLATOON:	COMPANY:		BATTALION:						
TASK	CONDITIONS/ TARGETS/ SITUATION	TOTAL TARGET EXPOSURE TIME	HITS	ENGAGEMENT TIMES	POINTS	CREW LEADER CUTS	TOTAL POINTS		
1. ENGAGE MULTIPLE TARGETS	FRED FROM BASELINE. 3,100 - 3,750 METERS ± 200M 1-1ST TANK, 1-1ST BMP	40 SECONDS	8	ST 20 SB 30	74 35		55		
2. ENGAGE A SINGLE TARGET	FRED FROM PHASE LINE 2. 2,100 - 2,750 METERS ± 200M 1-1ST BMP	1MIN - 40SEC	0	SB 20	74		74		
3. ENGAGE MULTIPLE TARGETS	FRED FROM PHASE LINE 3. 1,000 - 1,500 METERS ± 200M 2-1ST TANK, 2-1ST BMP, 1-1ST TANK	2MIN - 45SEC	3	MB 10 MB 18 ST 13	41 87 100		43		
4. ENGAGE MULTIPLE TARGETS	FRED FROM PHASE LINE 1. 2,100 - 3,000 METERS ± 200M 2-1ST TANKS, 2-1ST TANKS (INCL)	2MIN - 38SEC	3	MT 19 MT 20 ST 22	100 74 44	-10 2-1ST TANKS 1-1ST TANK COMMAND	74		
5. ENGAGE MULTIPLE TARGETS	FRED FROM BASELINE. 1,000 - 1,500 METERS ± 200M 1-1ST TANK, 1-1ST BMP (INCL)	25 SECONDS	2	ST 14 SB 17	85 92			TOTAL SCORE: <u>385</u>	

NOTES:

1. ENGAGEMENT TIMES ARE CALCULATED FROM THE TIME THE TARGET IS EXPOSED TO THE TIME THE TARGET IS HIT. USE THE LIVE FIRE POINT CALCULATION SHEET FOR SECOND AND THIRD ENGAGEMENTS FROM THE SAME POSITION. THE TIME IS STARTED WHEN THE VEHICLE REOCCUPIES ITS FIRING POSITION (STOP MOVING) AND ENDS WHEN THE TARGET IS HIT.
2. SCORING EXERCISE B: EXERCISE B IS PERFORMED TWICE, ONCE DURING THE DAY AND ONCE AT NIGHT. EACH EVENING IS WORTH A MAXIMUM OF 500 POINTS FOR A POSSIBLE TOTAL OF 1,000 POINTS. EXERCISE B IS A PRACTICE EXERCISE. IN ORDER TO VERIFY ON EXERCISE 9 AND PROCEED TO EXERCISE 10, THE SECTION MUST ACHIEVE A MINIMUM COMBINED SCORE OF AT LEAST 700 POINTS, AFTER CREW AND LEADER CUTS.

DA FORM 7544-R, JAN 2005 APR 03

Figure 6-7. Example completed DA Form 7544-R.

**ITAS GUNNERY EXERCISE 10: SECTION GUNNERY QUALIFICATION FTI**  
 For use of this form, see FM 3-22.32; the proponent agency is TRADOC.

SECTION	TC: <u>SSG HUGHES</u> LDR: _____	GNR: <u>PFC KIM</u> DVR: <u>PFC SMITH</u>	DATE: <u>28 AUG 04</u>	TIME: <u>1600</u>	CHECK ONE DAY <input type="checkbox"/> NIGHT <input type="checkbox"/>
SQUAD	TC: <u>SSG WHITE</u> LDR: _____	GNR: <u>PFC LUCKY</u> DVR: <u>PFC ROMEO</u>	BATTALION: _____		
PLATOON:	COMPANY: _____				

TASK	CONDITIONS/ TARGETS/ SITUATION	TOTAL TARGET EXPOSURE TIME	HITS	ENGAGEMENT TIMES	POINTS	CREW/ LDR CUTS	TOTAL POINTS
1. ENGAGE MULTIPLE TARGETS	FIRE FROM BASELINE. 3,000 - 3,750 METERS ± 200M 2-MV TANK, 2 ST BMP	25 SECONDS	① ② ③ ④	MT 30 MT 37 SB 17 SB 16	96 93 92 100		85
2. ENGAGE A SINGLE TARGET	FIRE FROM PHASE LINE 2. 2,000 - 2,500 METERS ± 200M 1-MV TANK	40 SECONDS	①	MT 40	83		83
3. ENGAGE MULTIPLE TARGETS	FIRE FROM PHASE LINE 3. 1,000 - 1,500 METERS ± 200 M 1-MV BMP, 1-ST TANK	25 SECONDS	② ③	ST 64 MB 59	64 59		62
4. ENGAGE MULTIPLE TARGETS	FIRE FROM PHASE LINE 2. 2,500 - 3,000 METERS ± 200 M 1-ST BMP, 2-MV TANKS (NBC)	2MIN - 40SEC	② ③	SB 18 MT 34 MT 24	86 94 98		93
5. ENGAGE MULTIPLE TARGETS	FIRE FROM BASELINE 3,000 - 3,750 METERS ± 200 M 1-ST TANK, 1-ST BMP (NBC)	25 SECONDS	① ?	ST 20 MB 0	74	-10 SALVO ENGAGEMENT TECHNIQUE	37
NOTES:						TOTAL SCORE: <u>360</u>	

1. ENGAGEMENT TIMES ARE CALCULATED FROM THE TIME THE TARGET IS EXPOSED TO THE TIME THE TARGET IS HIT. USE THE LIVE FIRE POINT CALCULATION SHEET FOR SECOND AND THIRD ENGAGEMENTS FROM THE SAME POSITION. THE TIME IS STARTED WHEN THE VEHICLE OCCUPIES ITS FIRING POSITION (STOPS MOVING) AND ENDS WHEN THE TARGET IS HIT.

2. EXERCISE 10, UNLIKE EXERCISE 9, IS FOR QUALIFICATION. THE SQUAD IS RATED ON ITS FINAL SCORE, RATHER THAN SIMPLY HAVING TO MEET A MINIMUM STANDARD.

3. SCORING EXERCISE 10 IS PERFORMED TWICE, ONCE DURING THE DAY AND ONCE AT NIGHT. EACH EVENT IS WORTH A MAXIMUM OF 500 POINTS FOR A POSSIBLE TOTAL OF 1,000 POINTS. EXERCISE 10 IS A QUALIFICATION EXERCISE. IN ORDER TO PROGRESS TO EXERCISE 11, THE SECTION MUST ACHIEVE A MINIMUM COMBINED SCORE OF AT LEAST 700 POINTS.

<input type="checkbox"/> DISTINGUISHED: 900 - 1,000 POINTS	<input type="checkbox"/> SUPERIOR: 800 - 899 POINTS	<input type="checkbox"/> QUALIFIED: 700 - 799 POINTS	<input type="checkbox"/> UNQUALIFIED: 0 - 699 POINTS
---	--	---	---

DA FORM 7545-R, JAN 2005  
APV100

Figure 6-8. Example completed DA Form 7545-R.

d. **Phase IV—Platoon Training.** Phase IV consists of sustainment training, as necessary, to prepare for ITAS Gunnery Exercise 11 and 12.

- ITAS Gunnery Exercise 11, Platoon Gunnery Practice (in preparation for Exercise 12). Use DA Form 7546-R (ITAS Gunnery Exercise 11: Platoon Gunnery Practice FTT) to score exercise 11. (Figure 6-9 shows an example of a completed DA Form 7546-R.)
- ITAS Gunnery Exercise 12, Platoon Gunnery Qualification. Use DA Form 7547-R (ITAS Gunnery Exercise 12: Platoon Gunnery Qualification FTT) to score exercise 12. (Figure 6-10, page 6-14, shows an example of a completed DA Form 7547-R.)

ITAS GUNNERY EXERCISE 11: PLATOON GUNNERY PRACTICE FTT <small>For use of this form, see FM 3-22.32; the proponent agency is TRMOC.</small>									
SECTION 1:	TOW CREW 1:	TC:	LDR:	GHR:	SPL COOK	DVR:	PFC BROWN	DATE:	TIME:
SECTION 2:	TOW CREW 2:	TC:	LDR:	GHR:	SPL ADAMS	DVR:	PFC SANDLEY	15 AUG 04	
	TOW CREW 1:	TC:	LDR:	GHR:	SPL MCCOY	DVR:	PFC SALAS		
	TOW CREW 2:	TC:	LDR:	GHR:	SPL BROWN	DVR:	PFC JONES	1100	
SECTION 3:	TOW CREW 1:	TC:	LDR:	GHR:	SPL GLAVIS	DVR:	PFC SMITH		
	TOW CREW 2:	TC:	LDR:	GHR:	SPL SMITZ	DVR:	PFC ANDERSON		
PLATOON:		COMPANY:		BATTALION:					
TASK	CONDITIONS/TARGETS/SITUATION	TOTAL TARGET EXPOSURE TIME	HITS	ENGAGEMENT TIMES	POINTS	CREW LOR CUTS	TOTAL POINTS		
1. ENGAGE MULTIPLE TARGETS	FIRE FROM BASELINE. 3,000 - 3,750 METERS ± 200M 4 MW TANK, 2 ST BMP	3MIN ± 30SEC	000000	MT 33 MT 33 MT 31 MT 31 ST 22 ST 22 ST 22	95 93 94 94 93 93 93		90		
2. ENGAGE MULTIPLE TARGETS	FIRE FROM PHASE LINE 2. 2,000 - 3,000 METERS ± 200M 4 MW BMPs, 2 ST BMPs	2MIN ± 30SEC	000000	MT 19 MT 19 MT 23 MT 25 ST 10 ST 10	71 71 71 71 71 71		71		
3. ENGAGE MULTIPLE TARGETS	FIRE FROM PHASE LINE 3. 1,000 - 2,000 METERS ± 200 M 2 ST BMPs, 2 ST BMPs	25 SECONDS	000000	MT 17 MT 21 MT 21 ST 26 ST 26	72 72 72 72 72		72		
4. ENGAGE MULTIPLE TARGETS	FIRE FROM PHASE LINE 2. 2,000 - 3,000 METERS ± 200 M 2 MW TANKS, 2 MW BMP (NBC)	43 SECONDS	000000	MT 17 MT 23 MT 23 MT 19 ST 15 ST 21 ST 24 ST 24 ST 0 ST 0	85 85 85 85 85 85 85 85 85 85	-10 EMERGER DIMMED	85		
5. ENGAGE MULTIPLE TARGETS	FIRE FROM BASELINE. 3,000 - 3,750 METERS ± 200 M 2 ST TANK, 2 ST BMP (NBC)	25 SECONDS	000000		56		56		
NOTES: EXERCISE 11 IS CONDUCTED, TIMED, AND SCORED IN EXACTLY THE SAME MANNER AS THE PREVIOUS EXERCISES 7 THRU 10.							TOTAL SCORE:	394	
<input type="checkbox"/> DISTINGUISHED: 800 - 1,000 POINTS		<input type="checkbox"/> SUPERIOR: 800 - 899 POINTS		<input type="checkbox"/> QUALIFIED: 700 - 799 POINTS		<input type="checkbox"/> UNQUALIFIED: 0 - 699 POINTS			
DA FORM 7546-R, JAN 2005									

Figure 6-9. Example completed DA Form 7546-R.

**ITAS GUNNERY EXERCISE 12: PLATOON GUNNERY QUALIFICATION FTI**  
 For use of this form, see FM 3-22.32; the proponent agency is TRADOC.

SECTION 1:	TC: <u>SSG COLLIER</u>	LDR: <u>SPL SMITH</u>	GNR: <u>SPC BROOKS</u>	DVR: <u>PFC MILES</u>	DATE: <u>15 AUG 04</u>
	TC: <u>CPL YORK</u>	LDR: <u>SPC WINTERS</u>	GNR: <u>SPC CARTER</u>	DVR: <u>PFC PORTER</u>	
SECTION 2:	TC: <u>SSG BUSH</u>	LDR: <u>SPC WINTERS</u>	GNR: <u>SPC CARTER</u>	DVR: <u>PFC JOHNSON</u>	TIME: <u>1400</u>
	TC: <u>SGT KIM</u>	LDR: <u>PFC CLAY</u>	GNR: <u>SPC PRICE</u>	DVR: <u>PFC YOUNG</u>	
SECTION 3:	TC: <u>SSG BLAND</u>	LDR: <u>SPC OLIVER</u>	GNR: <u>SPC SELLARS</u>	DVR: <u>PFC COLE</u>	CHECK ONE <input type="checkbox"/> DAY <input type="checkbox"/> NIGHT
	TC: <u>SGT WALKER</u>	LDR: <u>PFC HARRIS</u>	GNR: <u>SPC HUNTER</u>	DVR: <u>PFC PATIA</u>	
PLATOON:	<u>ZND</u>		COMPANY: <u>E</u>	BATTALION: <u>5/6 IN</u>	

TASK	CONDITIONS/TARGETS/SITUATION	TOTAL TARGET EXPOSURE TIME	HITS	ENGAGEMENT TIMES	POINTS	CREW/LDR COTS	TOTAL POINTS	
1. ENGAGE MULTIPLE TARGETS	FIRED FROM BASELINE. 3,000 - 3,750 METERS ± 200M. 2-MV TANK. 2-ST BMP	25 SECONDS	① ② ③	MT 28 MT 0 SB 19 SB 23	92 59 79		58	
2. ENGAGE MULTIPLE TARGETS	FIRED FROM PHASE LINE 2. 2,000 - 3,000 METERS ± 200M. 3-ST BMP. 3-MV TANKS	2MIN : 28SEC	① ② ③ ④ ⑤ ⑥ ⑦ ⑧	SB 20 SB 17 SB 22 MT 33 MT 38 MT 0	74 94 94 90 90 0	-10 INCORRECT FIRE COMMAND	59	
3. ENGAGE MULTIPLE TARGETS	FIRED FROM PHASE LINE 3. 1,000 - 2,000 METERS ± 200 M. 3-ST TANKS. 3-MV BMP	1MIN : 8SEC	① ② ③ ④ ⑤ ⑥ ⑦ ⑧	ST 17 ST 19 ST 26 MB 21 MB 24 MB 20	92 74 47 57 61 0		56	
4. ENGAGE MULTIPLE TARGETS	FIRED FROM PHASE LINE 2. 2,000 - 3,000 METERS ± 200 M. 2-MV TANKS. 2-MV BMP (NBC)	34 SECONDS	① ② ③ ④	MT 23 MT 26 MB 15 MB 0	86 95 100 0	-10 INCORRECT FIRE COMMAND	73	
5. ENGAGE MULTIPLE TARGETS	FIRED FROM BASELINE. 3,000 - 3,750 METERS ± 200 M. 2-ST TANK. 2-ST BMP (NBC)	25 SECONDS	① ② ③ ④	ST 15 ST 17 ST 17 SB 23	100 92 92 59		76	
NOTES: EXERCISE 12 IS CONDUCTED, TIMED, AND SCORED IN EXACTLY THE SAME MANNER AS THE PREVIOUS EXERCISES 7 THRU 11.							TOTAL SCORE: <u>322</u>	

DISTINGUISHED: 900 - 1,000 POINTS  
 SUPERIOR: 800 - 899 POINTS  
 QUALIFIED: 700 - 799 POINTS  
 UNQUALIFIED: 0 - 699 POINTS

DA FORM 7547-R, JAN 2005 APV 1.00

Figure 6-10. Example completed DA Form 7547-R.

## APPENDIX A SAFETY

*Units should develop local directives and standing operating procedures (SOPs) for safety procedures. These should include individual responsibilities, safety requirements, proximity limits for personnel and explosives, location and sequence of operations, equipment required for handling munitions, and protection for troops. Individual responsibility for operations involving explosives **must** be designated. Troops must not tamper with the encased missiles other than to remove the forward handling ring and dust cover.*

*Because of the danger to troops from the backblast, extreme care must be used in all phases of training. This danger should be emphasized from the first stage of training. All crew tasks, position and tracking exercises, and firings with the simulation round should be conducted as though missiles were being fired.*

### A-1. SAFETY PRECAUTIONS

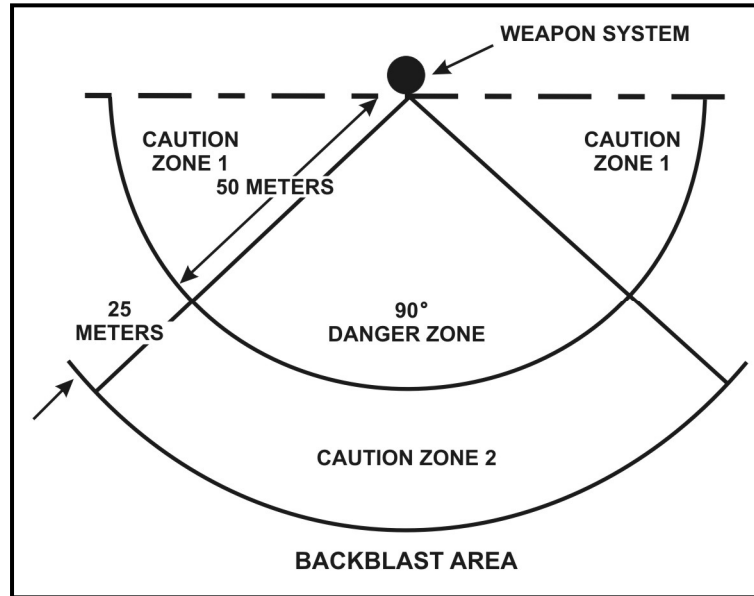
The TOW backblast area extends 75 meters to the rear of the launcher and forms a 90-degree danger area. It is divided into a danger zone and a caution zone.

a. The danger zone extends 50 meters to the rear of the launcher. In this zone, serious casualties or fatalities are likely to occur from the blast and flying debris.

b. The caution zone extends an additional 25 meters to the rear of the danger zone. In this zone, a soldier is safe provided he does not face the aft end of the launcher. During training, the caution zone must be clear (Figure A-1, page A-2). (For further information on ITAS firing limitations, see Chapter 2.)

### **WARNING**

**All crew members must wear V-51R (or equivalent) earplugs that have been fitted by qualified medical personnel. Failure to use the proper earplugs during missile firing could cause serious injury.**



**Figure A-1. TOW backblast area.**

c. The surface danger zone for any firing range consists of a firing area, a target area, impact area, and danger areas surrounding these locations. An additional area for occupation by personnel during firings may also be required. The shape and size of the surface danger zone varies with the type of missile or rocket being fired. (Refer to AR 385-63 for dimensions.)

### **WARNING**

**When firing the ITAS from confined spaces, such as dugouts or rooms, the gunner must be aware that structural damage to the enclosure may occur and occupants might be injured by flying debris. Severe concussion and concentration of toxic gases may result. There is also a danger of starting fires.**

d. In accordance with AR 385-63, the ITAS will not be fired from buildings or bunkers, or within 100 meters of a vertical or nearly vertical backstop without the approval of the commanding general.

## **A-2. MISSILE HANDLING PRECAUTIONS**

Improper handling of the encased missile may damage the components and cause malfunctions when the missile is launched. If the encased missile is dropped, the end handling rings and the launch container may be damaged. If the missile has been damaged or there is damage to the launch container (other than minor deformation of

handling rings), the encased missile should be returned to the ammunition unit for inspection and disposition.

### **A-3. SIGHTING AND AIMING PRECAUTIONS**

Gunners must not look at the sun or bright lights while sighting through the daysight tracker—serious eye burn could result. They must not look through the daysight tracker at an air field test set on the control tower unless the distance between the daysight tracker and the test set is more than 300 feet.

### **A-4. FIRING ANGLE LIMITATIONS**

Azimuth and elevation firing angles are limited by the traversing unit, the vehicle, and other external restrictions. All elevation angles are referenced to the horizontal plane of the traversing unit. All azimuth angles are referenced to the long axis of the vehicle and depend on whether the launch tube points over the front or rear of the vehicle. The other reference line is the line of sight from the ITAS to the target. (The firing angle limitations of the ITAS carriers are shown in Figure A-2, page A-4.)

#### **WARNING**

**At angles greater than 20 degrees above ground level, hazards to the gunner may exist in the overpressure waves and debris caused by the backblast during training. Do not use angles greater than 20 degrees.**

a. When the ITAS is tripod-mounted, a 360-degree lateral track is possible, because the traversing unit is not restricted in azimuth. Mechanical stops limit the elevation angle coverage to 20 degrees below and 30 degrees above the horizontal plane.

b. Before the missile is fired, the line-of-sight angle should be estimated at the expected time of launch and throughout the expected missile flight time. The firing position should be changed or a different target selected if a line-of-sight angle exceeds the firing limitation angle.

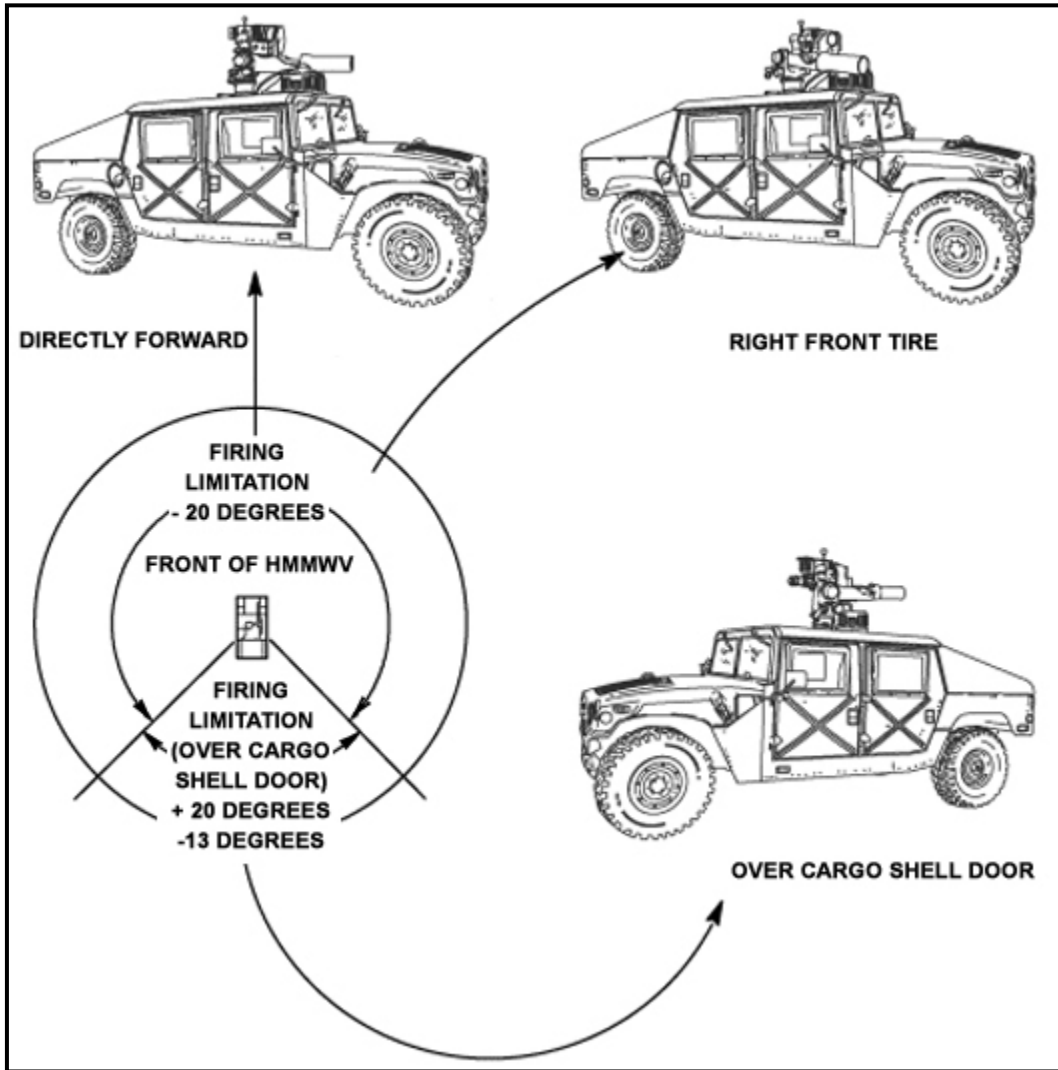


Figure A-2. Firing limitations.

**A-5. SAFETY PRECAUTIONS FOR FIELD TACTICAL TRAINER**

The following safety precautions must be observed when using the FTT.

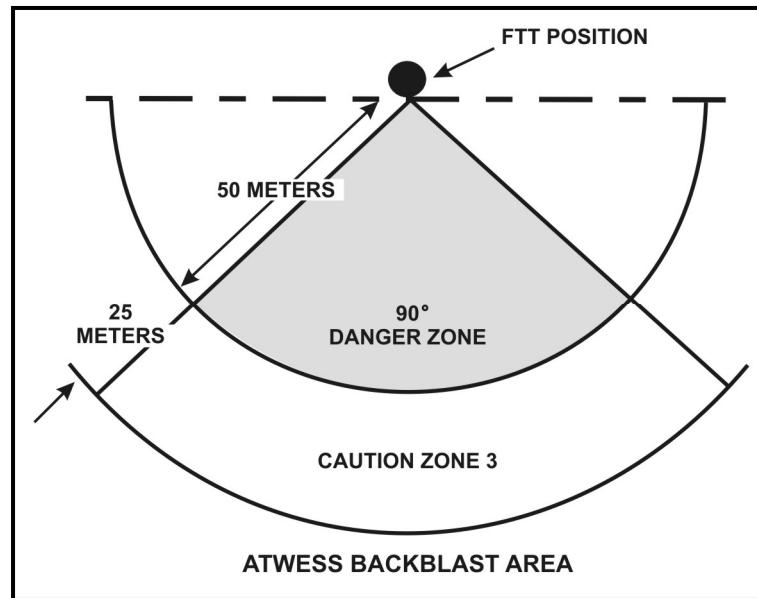
**DANGER**

THE ATWESS BLAST SIMULATOR USED WITH THE FTT CAN CAUSE DEATH OR INJURY. OBSERVE THE PRECAUTIONS LISTED IN THE PREFACE OF TM 9-6920-721-10.



a. Do not load an ATWESS cartridge until ready to fire. If the target is lost, remove the ATWESS cartridge from the firing chamber before moving the FTT. (Gloves are recommended when loading or unloading the ATWESS cartridge.)

b. Before pulling the PULL-TO-ARM switch, always check to ensure no personnel or equipment (antennas) are in the ATWESS danger zone, which extends for 75 meters behind the ATWESS firing chamber and covers an arc 90 degrees wide (Figure A-3).



**Figure A-3. ATWESS danger zone.**

c. The laser light emitted by the FTT is considered eye safe, but suitable precautions must be taken to avoid possible eye damage from overexposure to this radiated energy. The preface to TM 9-6920-721-10, the laser range safety procedures in AR-385-63, and TB MED-279 discuss these precautions.

d. Never view the laser being fired through stabilized optics, such as binoculars or telescopic weapon sights, when within 75 meters of the transmitter.

e. To avoid personnel injury and equipment damage, four people are needed to lift and carry each shipping container.

**DANGER**  
**THIS EQUIPMENT USES HIGH VOLTAGE TO OPERATE. DEATH ON CONTACT MAY RESULT IF PERSONNEL FAIL TO OBSERVE THE SAFETY PRECAUTIONS LISTED IN TM 9-6920-721-10.**

**A-6. SAFETY PRECAUTIONS FOR THE BASIC SKILLS TRAINER**

The following safety precautions must be observed when using the BST.

**DANGER**

**THIS EQUIPMENT USES HIGH VOLTAGE TO OPERATE. NEVER USE UNGROUNDED EXTENSION CORDS, UNGROUNDED ADAPTERS, OR ANY UNGROUNDED OUTLET TO CONNECT THE BST. DEATH ON CONTACT MAY RESULT IF PERSONNEL FAIL TO OBSERVE SAFETY PRECAUTIONS.**

- a. Use two people to lift the instructor console. The console is heavy and lifting by only one man could result in serious injury.
- b. Do not attempt to open shipping cases before pressing the air pressure release valves on the side of the cases. Serious injury to personnel could result from opening cases with high pressure inside.
- c. Turn off the power to the BST and disconnect the wall outlet plug before beginning cleaning procedures.

## APPENDIX B

# ITAS TRAINING DEVICES

*The ITAS training devices consist of the ITAS BST, which is the indoor trainer, and the FTT, which is the force-on-force trainer. The BST will be used in place of the TOW gunner trainer (TGT) to qualify individual gunners and for additional sustainment training as the unit deems necessary. The ITAS FTT will be used in place of the TOW field tactical trainer (TFTT) for outdoor tracking sustainment and in place of MILES when conducting Tables 5 through 12 of the ITAS training tables.*

*The ITAS FTT provides realistic device-based training for simulating tactical engagements. It is valuable in maneuver training exercises and Army training and evaluation programs. However, the ITAS FTT is not a precision gunnery trainer and should not be used to train gunner tracking skills.*

### Section I. ITAS BASIC SKILL TRAINER

The BST is the training device that the ITAS gunner will use to conduct initial, sustainment, and qualification training. The BST has a variety of exercises that require the gunner to engage targets that replicate the engagement procedures of the M41 ITAS.

#### B-1. COMPONENTS AND FEATURES

The BST consists of BST-unique components and ITAS components. The major BST-unique components are the instructor station and the student station (Figure B-1). The ITAS components are the traversing unit, tripod, and the launch tube.



Figure B-1. Instructor station and student station.

a. The BST simulates the sight(s), controls, switches and indicators of the M41 ITAS. Battlefield scenes, which include both enemy and friendly vehicles, can be seen through the gunner's sight(s). Using the controls and switches, the gunner selects a target, fires, and tracks it. The headsets simulate the blast of the TOW and the "singing" of the wire. The gunner sees and hears hit-and-miss explosions, hears commands from the instructor, and hears battlefield sounds of small arms and guns. The score is displayed at the end of each mission.

b. The BST provides novice gunnery skill training, gunnery skill progression, and sustainment training. It is used to train the following skills:

- Correct firing position.
- Target identification.
- Target engageability determination.
- Target engagement, including tracking and firing.
- Fire commands.

### **B-2. ASSEMBLY AND OPERATION**

The following manuals are used for proper assembly and operation of the BST. (These manuals are under development.)

a. The BST operator's guide discusses procedures for unpacking, assembly, disassembly, and repacking for storage and or shipment.

b. TM 9-6920-721-10 discusses preparation for operation, preliminary inspections, warm-up, and operational checkout procedures.

c. TM 9-6920-721-10 discusses operating procedures performed by the instructor in order to conduct training.

### **B-3. SAFETY PRECAUTIONS**

The following safety precautions should be observed when using the BST.

a. Use two people to lift the instructor console. The console is heavy and lifting by only one man could result in serious injury.

b. Do not attempt to open shipping cases before pressing the air pressure relief valves on the side of the cases. Serious injury to personnel could result from opening cases with high pressure inside.

c. Turn off the power to the BST trainer and disconnect the wall outlet plug before beginning cleaning procedures.

**DANGER**  
**THIS EQUIPMENT USES HIGH VOLTAGE TO OPERATE. NEVER USE UNGROUNDED EXTENSION CORDS, UNGROUNDED ADAPTERS, OR ANY UNGROUNDED OUTLET TO CONNECT THE BST. DEATH ON CONTACT MAY RESULT IF PERSONNEL FAIL TO OBSERVE SAFETY PRECAUTIONS.**

## **Section II. ITAS FIELD TACTICAL TRAINER**

The FTT is used to teach precision gunnery skills to ITAS gunners in the field. This training can occur on designated ranges, in general outdoor areas, or in representative tactical environments. The FTT trains gunners to adopt a correct firing position, assess target engageability, and engage and track the target. Missile launch, flight, and impact effects are realistically simulated by the FTT.

### **B-4. COMPONENTS AND FEATURES**

The FTT consists of FTT-unique components and an ITAS weapon system. The FTT attaches to the ITAS and replaces some of its components. The FTT can be either tripod-mounted or HMMWV-mounted. It can be configured for the M1121 (Figure B-2, page B-4).

a. The FTT uses the ITAS weapon system equipment to enhance training realism. In addition, most of the FTT components resemble actual weapon system equipment. The FTT uses a retroreflector to designate its target. The retroreflector returns a portion of the laser beam generated by the gunner. The laser beam enables precise measurement of target range and location relative to the gunner. The retroreflector can be mounted on a variety of target vehicles, which can be maneuvered as required during a training mission. Targets equipped with MILES sensors can also be engaged by the FTT.

b. The FTT operator loads the M80 blast simulator, sets the duration of the obscuration that simulates the smoke produced at missile launch, and selects the relative size of the target. Following missile launch, the operator monitors gunner performance during missile flight. At the end of each mission, the operator is provided with a readout of mission results.

### **B-5. ASSEMBLY AND OPERATION**

The following manuals are used for proper assembly and operation of the FTT. (These manuals are currently under development.)

a. The BST operator's guide (M1121) discusses procedures for unpacking, assembly, disassembly, and repacking of the FTT.

b. TM 9-6920-721-10 (M1121) discusses procedures for preliminary inspection, power-up, and operational checkout of the FTT.

c. TM 9-6920-721-10 (M1121) discusses procedures for operating the FTT.



**Figure B-2. ITAS field tactical trainer components (M1121).**

#### **B-6. SAFETY PRECAUTIONS**

The laser light emitted by the FTT is considered eye safe, but suitable precautions must be taken to avoid possible eye damage from overexposure to this radiated energy. (See the preface to TM 9-6920-721-10 and the laser range safety procedures in AR-385-63 and TB MED-279 for these precautions.) To avoid personnel injury and equipment damage, four people are required to lift and carry each shipping container.

**DANGER**  
**THE ATWESS USED WITH THE FTT CAN CAUSE  
DEATH OR INJURY. OBSERVE THE PRECAU-  
TIONS LISTED IN THE PREFACE OF TM 9-6920-  
721-10.**

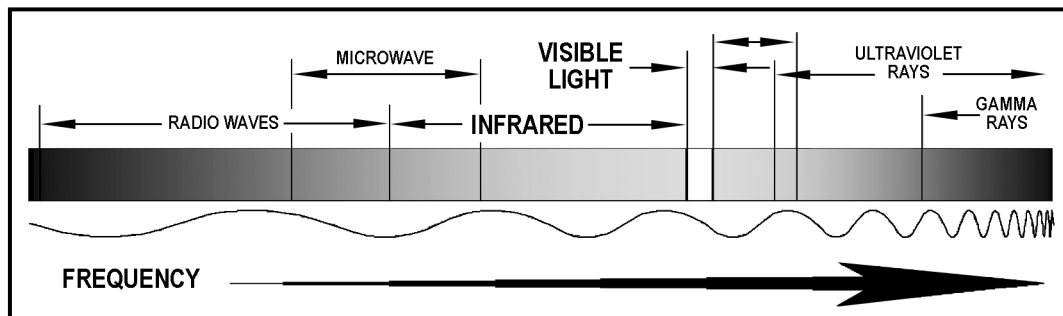
## APPENDIX C FORWARD LOOKING INFRARED

*This appendix provides the gunner with a greater understanding of how to acquire targets with the ITAS. Visible light is seen either directly from a light source or indirectly as the light reflects from an object into the eye. The ITAS can create images using the infrared part of the spectrum in a process referred to as imaging infrared or I2R.*

*The ITAS allows the gunner to see a target at night and during light rain, fog, haze, or dusty atmospheric conditions by taking advantage of a type of energy similar to visible light known as “infrared.”*

### C-1. ELECTROMAGNETIC SPECTRUM

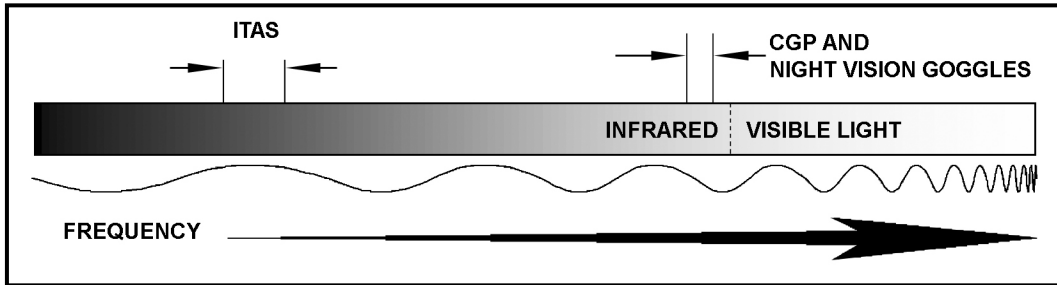
The electromagnetic spectrum (Figure C-1) contains various forms of energy including radio and television transmission spectrums, x-rays, and visible light humans can see. Visible light is a very small portion of the overall electromagnetic spectrum. Each type of energy is assigned a place in the spectrum according to its frequency—from lowest to highest. As the frequency changes, the characteristics change, so types of energy are bundled into groups of frequencies, or bands, which have similar characteristics. The ITAS uses the infrared band for its NVS.



**Figure C-1. Electromagnetic spectrum.**

a. The ITAS operates using frequencies in only a small part of the IR band (Figure C-2, page C-2). Other weapon systems operate in this same area, such as the Javelin and Dragon, which means the gunner should be able to see anything with the Javelin and Dragon that he can see with the ITAS.

b. Other systems operate using frequencies in other parts of the IR band. This includes such equipment as the commander’s ground pointer (CGP) and night vision goggles (NVG). Using the CGP and NVGs as an example, when the platoon leader points to a target with the CGP, the gunner can see what the platoon leader points at because the NVGs that the gunner wears operates at the same IR frequency as the CGP. Using the ITAS, the gunner cannot see where the CGP points because CGP emits a beam outside the IR band that the ITAS uses.



**Figure C-2. Infrared band.**

### C-2. INFRARED WAVES

Infrared waves are a form of energy traveling as an electromagnetic form of heat. Heat creates IR waves and IR waves create heat. For instance, the heat lamps at fast-food restaurants are above the food, yet they keep the food warm even though heat rises. The reason is that the lamps radiate IR waves down onto the food, and when the IR strikes the food, the food warms up. IR can be emitted in any direction.

a. **Infrared Sources.** Everything on the face of the earth emits IR in the IR band used by the ITAS. Hotter objects emit more IR, and cooler objects emit less. Some objects are classified as IR sources meaning they are able to stay hot by themselves using another form of energy—such as nuclear energy, combustion, and friction—to generate heat energy.

(1) **Nuclear Energy.** Nuclear energy is produced either by splitting atomic particles (called fission) or combining atomic particles together in different forms (called fusion). The sun uses a nuclear reaction to generate heat and is our primary source of IR energy.

(2) **Combustion** (Figure C-3). Combustion means there is heat produced by a slow burning (such as a bonfire) or very quick burning (such as a controlled explosion). Vehicle engines generate heat due to combustion.



**Figure C-3. Heat caused by combustion.**



(3) **Friction.** Friction produces heat by rubbing objects together. For example, when you rub your hands together very quickly, friction causes your hands to warm up, which causes them to give off more IR. The same reaction occurs when a vehicle moves. Its suspension and motion mechanism (tires or tracks) creates friction moving against themselves or against the ground causing the suspension parts to warm up and produce IR (Figure C-4).



**Figure C-4. Heat caused by friction.**

b. **Infrared Characteristics.** All objects have the IR characteristics of reflection (if IR energy is reflected as in a mirror), absorption (if IR energy is absorbed as in friction), and emission (if IR energy comes from an IR source as in combustion). Like visible light, IR is affected by being transmitted through the atmosphere.

(1) **Reflecting Versus Absorbing.** All objects reflect and absorb IR energy in varying amounts. What is not absorbed is reflected.

(a) Objects that reflect IR well do not absorb it well. Plant life, such as trees and grass, reflects IR well. This reflection makes the plants appear to heat up instantly when the sun strikes them and to cool off instantly when the sun blocks the plants.

(b) Absorbing is the opposite of reflecting. Objects that absorb IR well do not reflect it well. Objects such as tanks and rocks absorb IR well. When the sun comes up, this absorption makes these objects stay cold or cool for a longer time when everything else is warm. When the sun goes down, these objects stay hot much longer than other objects in the target scene. For example, illumination tape that becomes dimmer the longer it glows.

(2) **Emitting IR.** Emitting is closely associated with absorbing. Just like illumination tape that absorbs light before it glows, objects are heated to emit IR. For example, an emitting source is like the human body or a combustion engine that generates heat. When an object absorbs IR, it warms up. As it warms up, it emits more IR. When the heat source is removed, the object continues to emit IR, which causes it to cool off, and the amount of IR that it emits steadily decreases.

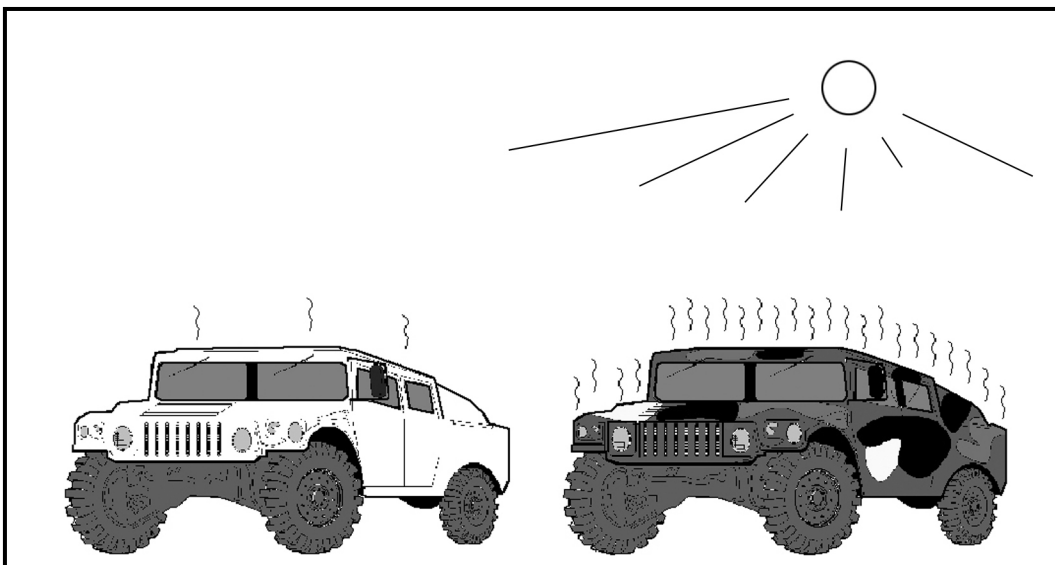
(3) **Transmitting IR.** Just like light, IR is affected by particles in the atmosphere known as *obscurants* because they obscure the gunner's view of the target scene.

(a) Obscurants include such things as dust, snow, hail, sleet, fog, and so forth. The effect these obscurants have on IR is noticeably less than their effect on light. Unlike light, some obscurants have no effect on the ability to see an IR image

(b) Obscurants with large-sized particles—snow, sleet, rain, fog, and some forms of smoke—affect the amount of IR that reaches the NVS. As these obscurants become thicker or heavier, the amount of IR that reaches the NVS decreases, which decreases the range at which a gunner can see a target with the NVS.

c. **Physical Properties.** When the sun comes up, some objects heat up faster than others because they have different IR characteristics. An object's IR characteristics are determined by its physical properties—mass, density, color, and texture. These properties combine to enhance an object's ability to reflect or absorb the IR that comes into contact with it.

(1) **Color.** Light colored objects, such as a vehicle with desert camouflage, reflect more IR than they absorb, and heat slowly in the sun (Figure C-5). Dark colored objects, such as a vehicle with woodland camouflage, absorb more IR than they reflect, and heat quickly in the sun.



**Figure C-5. Infrared affected by color.**

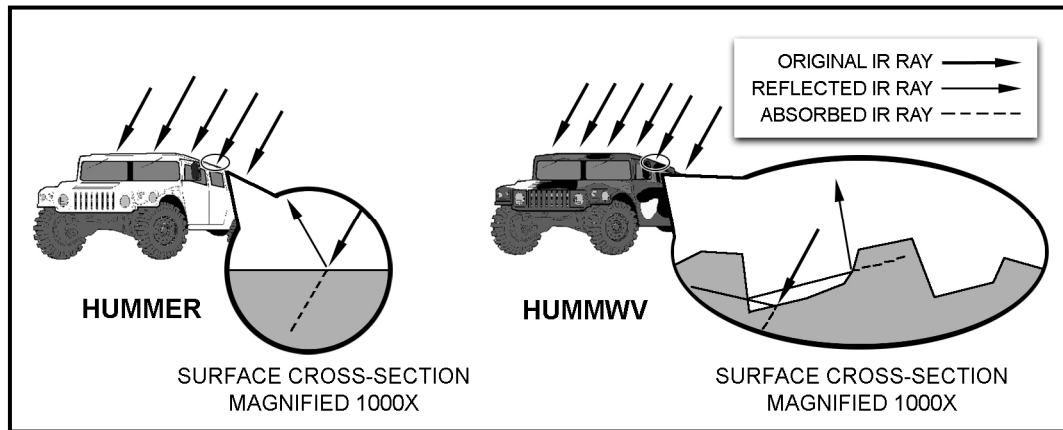
(2) **Density.** The density of objects affects how much IR they absorb and, therefore, emit.

(a) When objects such as trees and grass are exposed to sunlight, they do not become too hot to touch because they do not absorb IR well. As a result, they do not emit IR well, either. This is because the material they are made of is not very dense or heavy.

(b) When objects such as vehicles and rocks are exposed to sunlight, they can become too hot to touch. They absorb and emit IR well, because these objects are denser or heavier than the trees and grass.

(3) **Surface Texture.** Although a military HMMWV and the civilian version (Hummer) both become hot when exposed to sunlight, the Hummer does not heat up as fast as the HMMWV does. The reason for this is the difference in the surface texture, or

finish, on the two vehicles. The Hummer has a smooth, waxed surface which tends to reflect well, whereas the HMMWV has a rough surface due to the chemical-agent resistant coating (CARC) paint that tends to absorb well (Figure C-6).



**Figure C-6. Smooth versus rough surface texture.**

(4) **Mass.** The more mass an object has, the more IR it can absorb, the longer it takes to heat up, the longer it can emit IR, and the longer it takes to cool off. For example, when both a tank and an M16 are in the sun, the armor plates on the tank take longer to heat up than the barrel of the M16 because they have more mass. As a result, the armor plates absorb more IR, and they take longer to heat up to the same temperature as the M16 barrel. Once they are hot, the armor plates emit IR for a much longer time than the barrel of the M16, and they take longer to cool off.

### C-3. DELTA-T

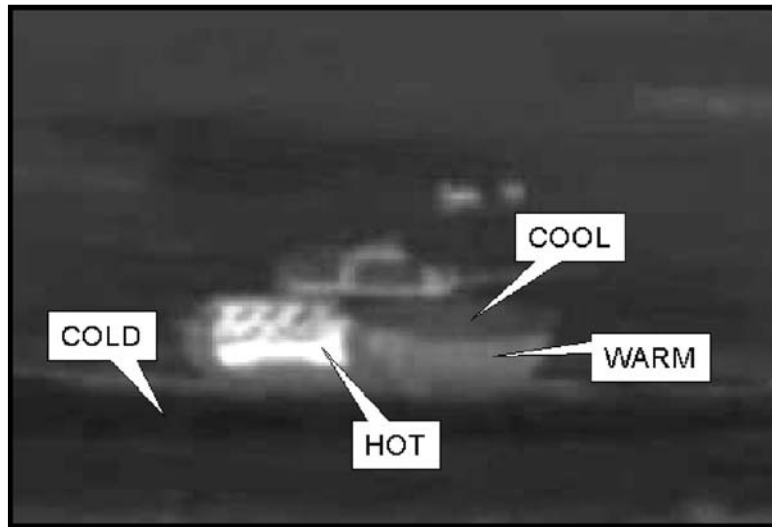
The NVS uses IR to create images regardless of visible light levels. The images it displays are made possible by the presence of Delta-Ts ( $\Delta T$  in graphics). Delta-Ts allow distinction between one part of the target scene and another—whether it is different parts of the same object or different objects in the target scene. The gunner can use the ITAS IR imagery during the day as well as at night.

a. **Definition.** Delta-T is an abbreviation for *change in temperature* or *difference in temperature*. Delta is a Greek letter ( $\Delta$ ) that stands for *change* or *difference*; T stands for temperature.

b. **Temperature/Infrared Relationship.** As the temperature of an object increases, so does the amount of IR it emits. For example, the engine compartment on a tank with its engine running emits more IR than the front of the hull.

c. **Display of Infrared Levels.** The NVS displays IR levels as a change in brightness, according to each object's temperature. The coldest objects in a target scene appear black; the hottest appear bright green. Everything in between appears as increasingly brighter shades of green as each object's temperature increases. For example, the engine compartment on a tank with its engine running appears bright green (Figure C-7, page C-6). Since the hull generally is the coldest part of a tank, it appears

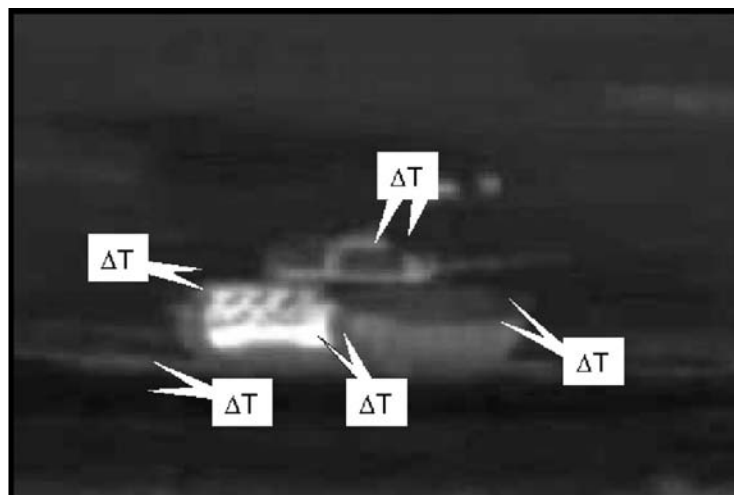
black. The suspension, which is hotter than the hull but cooler than the engine compartment, appears in a different shade of green.



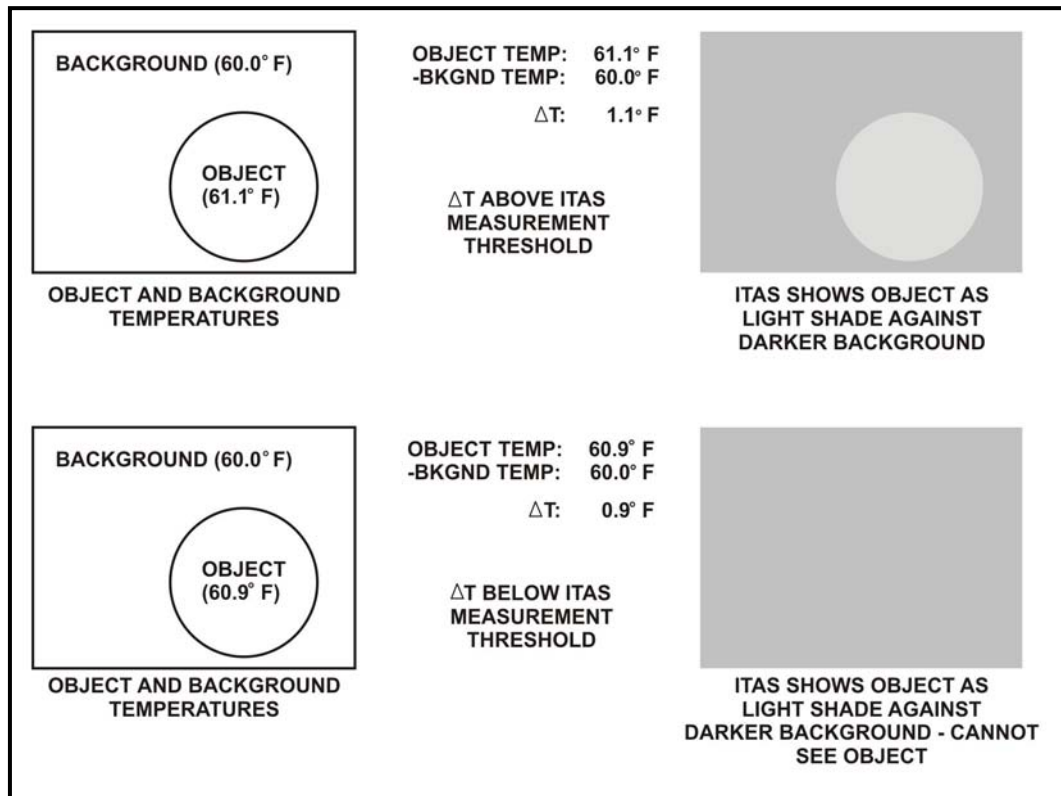
**Figure C-7. Display of IR levels.**

**NOTE:** In the figures shown, the coldest objects appear black and the hottest appear white (bright green in the TAS display). Everything in between appears as increasingly brighter shades of gray (shades of green in the TAS).

d. **Delta-T to Visible Image.** Delta-Ts occur between different objects in the target scene and between the different parts of a target. This technique allows the gunner to see different objects in the target scene, and to distinguish between different parts of a target (Figure C-8). For the gunner to see a target with the ITAS, a measurable Delta-T (which, for ITAS, is a difference between 1 degree Fahrenheit or greater) must exist between the target and its background (Figure C-9).



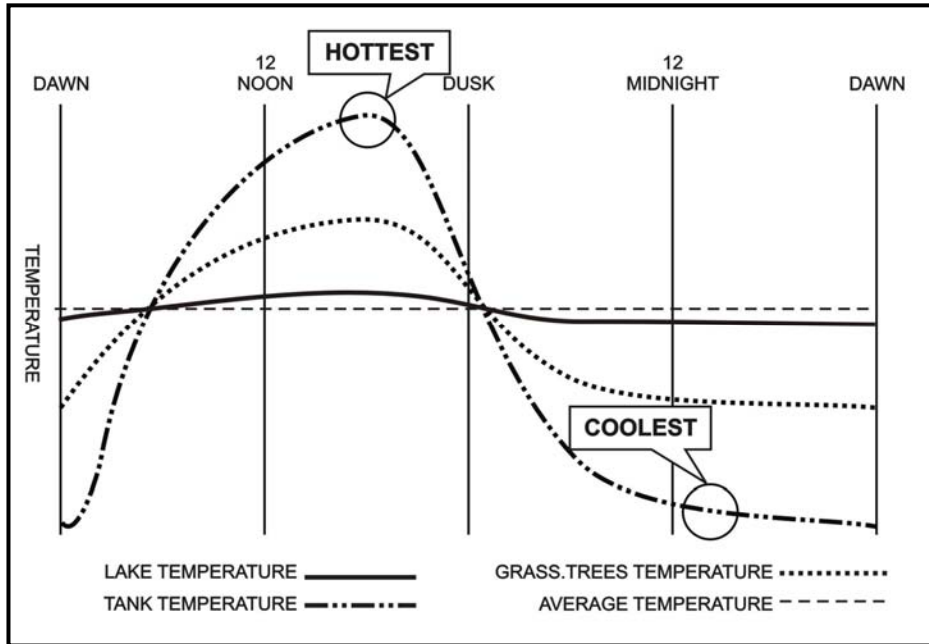
**Figure C-8. Delta-Ts.**



**Figure C-9. Measurable Delta-Ts.**

e. **Delta-Ts Over a 24-Hour Period.** The temperature relationship between one object and another changes during the day due to heating and cooling as the sun rises and sets (Figure C-10, page C-8).

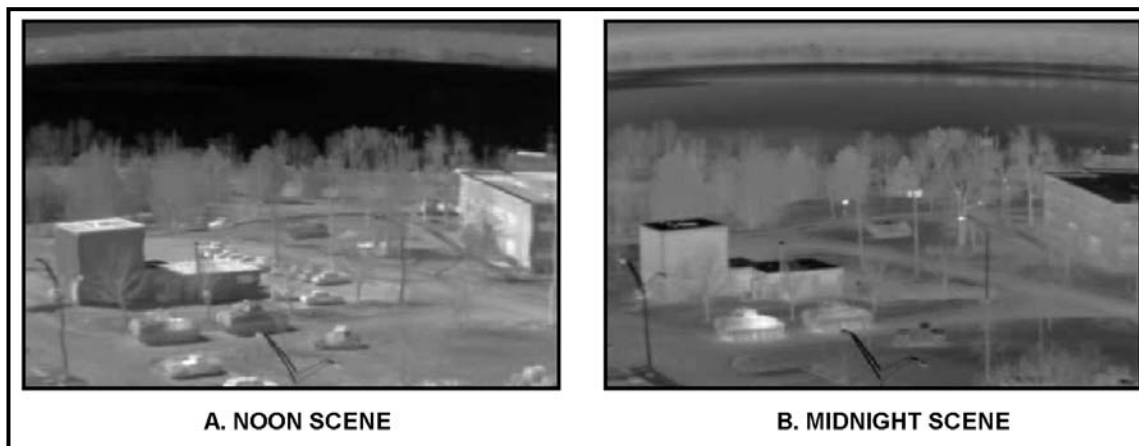
(1) The gunner knows that vehicles, buildings, and asphalt roads get hot in the sun. Grass and trees become warm, but not so hot they cannot be touched. Large bodies of water do not warm up noticeably in one day. Objects that heat up the most during the day tend to become the coldest at night. Objects that heat up very little during the day tend to cool off very little at night. Figure C-11 (page C-8) shows two images on the same terrain (one at noon and the other at midnight).



**Figure C-10. Temperatures of objects during 24-hour period.**

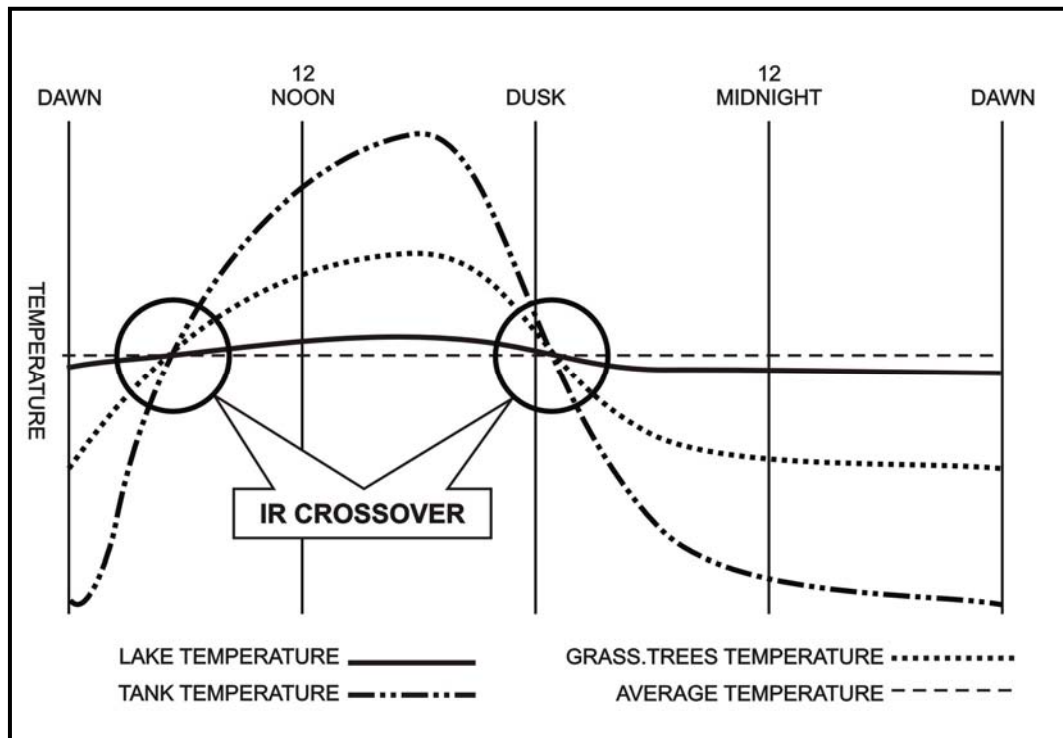
(a) In the noon example (A, Figure C-11), the buildings, roads, and vehicles are the hottest objects in the scene. The grassy areas and trees are shaded to indicate they are warm, and the river is black, which indicates it is the coolest object in the target scene.

(b) In the midnight example (B, Figure C-11), the Delta-Ts changed. Now, the river is the warmest, the grass and trees are next, with the roads and vehicles being the coolest (with the exception of the engine compartment and exhaust on the vehicles). This example shows how the relationship of Delta-Ts changes among objects in a target scene over the course of a day.



**Figure C-11. Delta-T changes from day to night.**

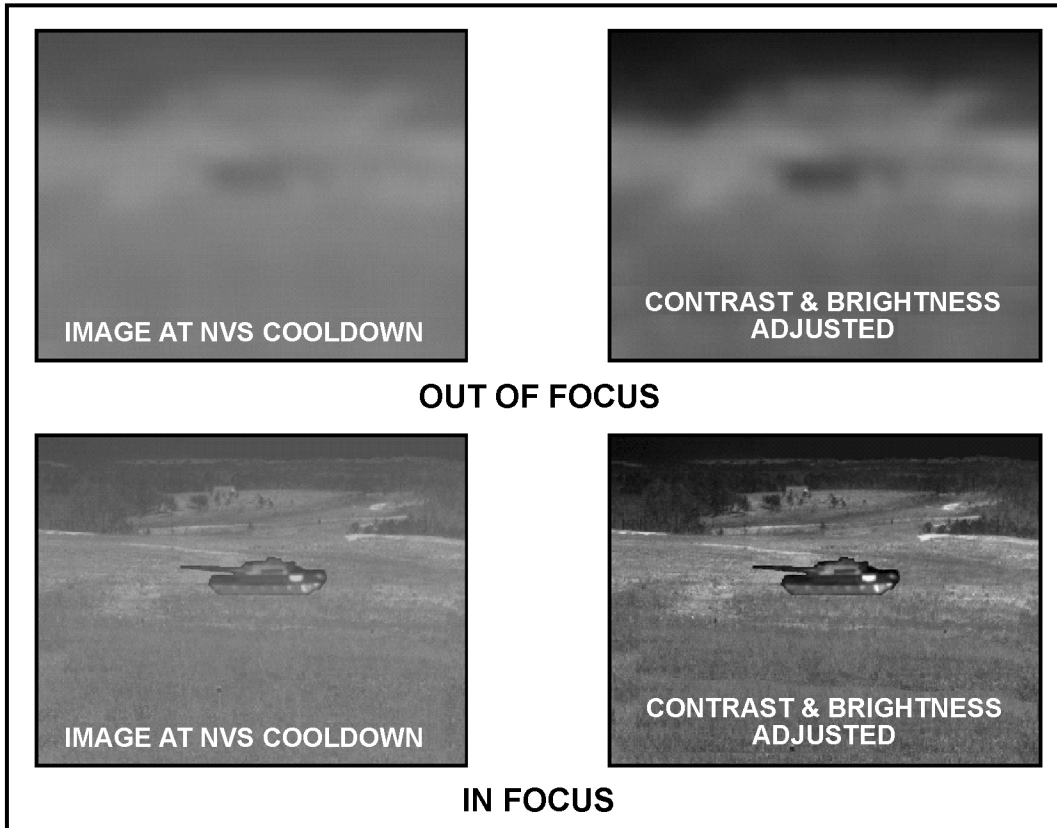
(2) Twice a day, around dawn and dusk, the temperatures of the tank, grass, and trees cross over from being hotter than the river to being cooler (Figure C-12). These two periods are known as *IR crossover* because of the change in the temperature relationships and the visual effect that it produces. During these two periods, everything in the target scene is about the same temperature, which means there are few, if any measurable Delta-Ts. As shown earlier, when there is no measurable Delta-T, the gunner cannot distinguish a target from its background.



**Figure C-12. Crossover periods.**

f. **Infrared Image Adjustment.** Proper image adjustment is vital to accomplish the mission because it allows the gunner to see targets that may otherwise be hidden. There is no *perfect* image adjustment. Image adjustment is subjective and should be done according to the gunner's preference.

(1) **Focus.** The BCF switch is used to adjust the NVS image focus. (An object is in focus when the gunner can easily identify its details or features.) Just like a camera, when an object is in focus in the NVS, anything closer or farther away appears out of focus. When the gunner first uses the NVS after cool down, he adjusts the focus before he adjusts the contrast and brightness. Otherwise, the edges of objects in the target scene are blurred, and the gunner is not able to adjust contrast and brightness properly (Figure C-13, page C-10).



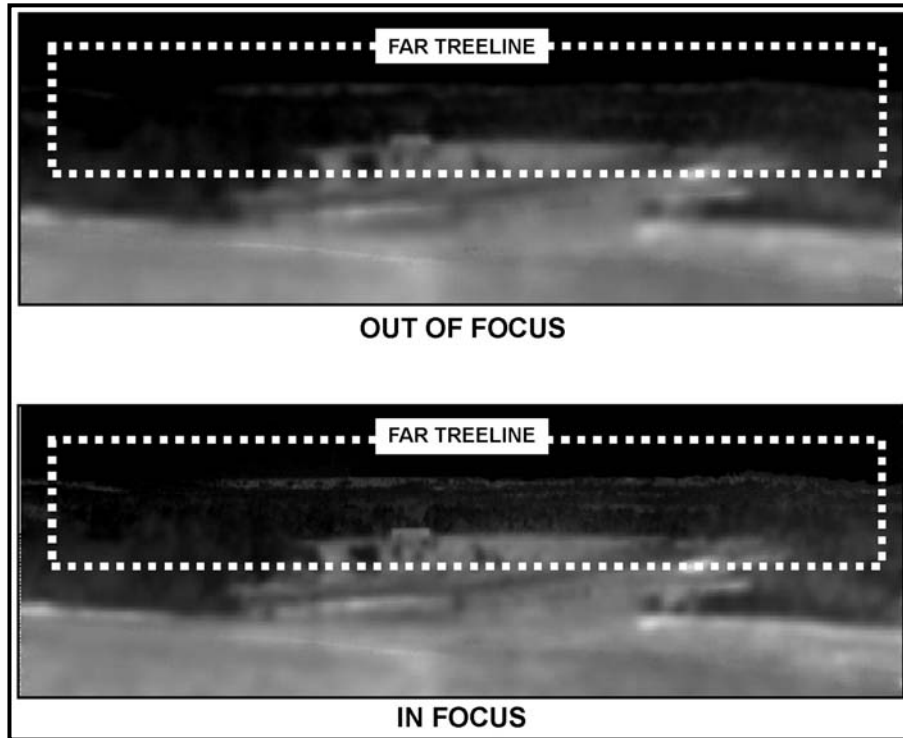
**Figure C-13. Focus adjustments.**

**NOTE:** Before focusing the NVS image, focus the TAS display with the diopter adjust ring.

(a) *Initial Adjustment.* To adjust focus initially—

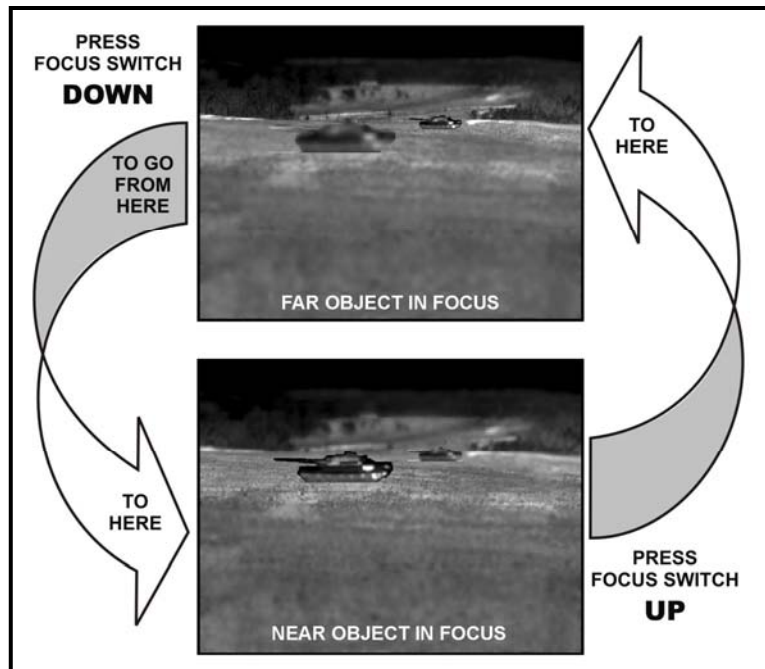
- Pick an object in the target scene such as a far tree line.
- Press the BCF switch to activate the BCF menu (Figure C-14).
- Select FOCUS on the BCF menu.
- Press the BCF switch up or down to make focus adjustments.
- When the tree line comes into focus, release the BCF switch. If the focus adjustment overshoots, press the BCF switch back and forth to make minor adjustments.





**Figure C-14. Focus on far tree line.**

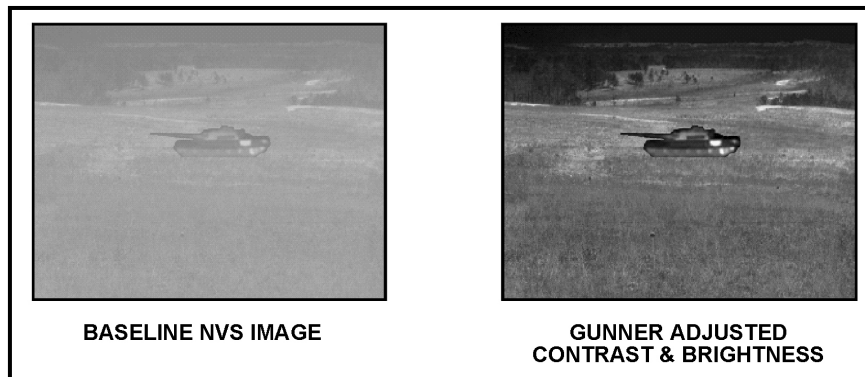
(b) *Focus Direction.* To focus on objects farther away, press the BCF switch up (Figure C-15). To focus on objects that are near, press the BCF switch down.



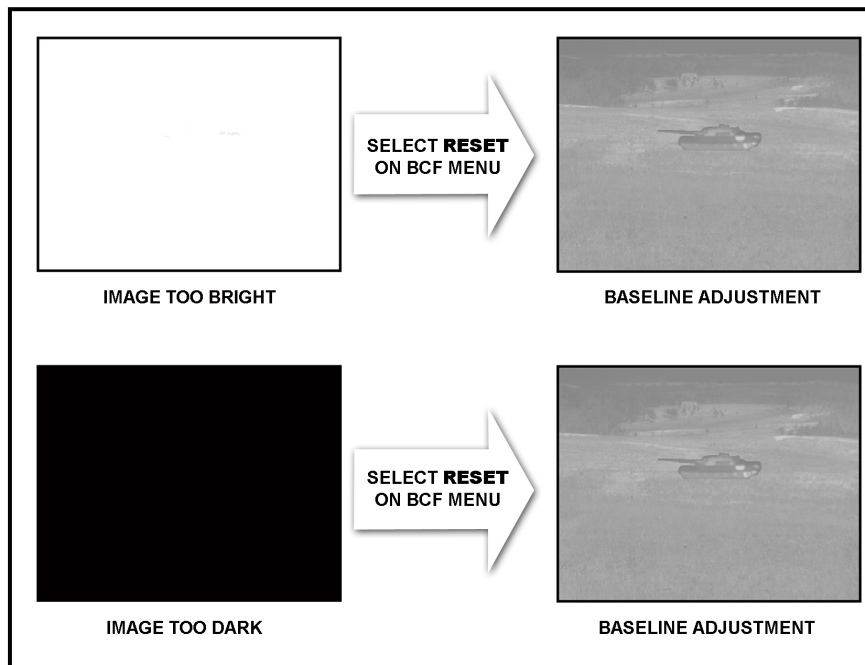
**Figure C-15. Focus direction.**

(2) **Contrast and Brightness Adjustment.** Once the image is in focus, it may be necessary to adjust the contrast and the brightness. As the situation changes, the gunner adjusts the focus, the contrast, and the brightness to help in target acquisition.

(a) **TAS Power-up.** When the power switch is turned to ON and the NVS reaches cool down, the NVS automatically adjusts contrast and brightness for the IR in the target scene (Figure C-16). This gives the gunner a baseline image for making an initial focus adjustment only. He still must fine-tune the contrast and brightness according to the task. If the gunner adjusts the contrast and brightness to an extreme (all black or all bright green) and cannot readjust to obtain a usable image, he takes corrective action by selecting RESET on the BCF menu. The NVS adjusts itself to the baseline image (Figure C-17).



**Figure C-16. NVS initial contrast and brightness baseline.**



**Figure C-17. Return to baseline from an extreme contrast/brightness adjustment.**

(b) *Proper Adjustment.* A properly adjusted target image is one in which the gunner sees a few black spots (the coldest objects) and a few bright green spots (the hottest objects) (Figure C-18). Everything else should be distributed across the shades of green.

- Adjusting the brightness affects the contrast, and adjusting the contrast affects the brightness. The gunner adjusts one, then the other, in small increments, until he has a target image that looks good to him for the task he is doing.
- If the gunner cannot tell whether to adjust the contrast or the brightness first because the entire screen appears bright green or the entire screen appears black, he adjusts the brightness first. If the gunner can see everything in the target scene, he adjusts the contrast first.

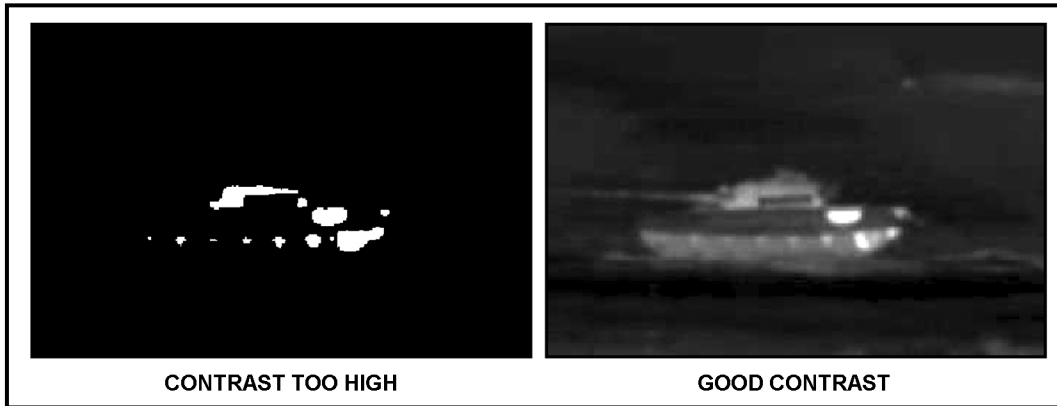


**Figure C-18. Properly adjusted contrast and brightness.**

(c) *Contrast Adjustment.* Contrast adjusts the difference between the bright green objects and the black objects with respect to the middle shades of green.

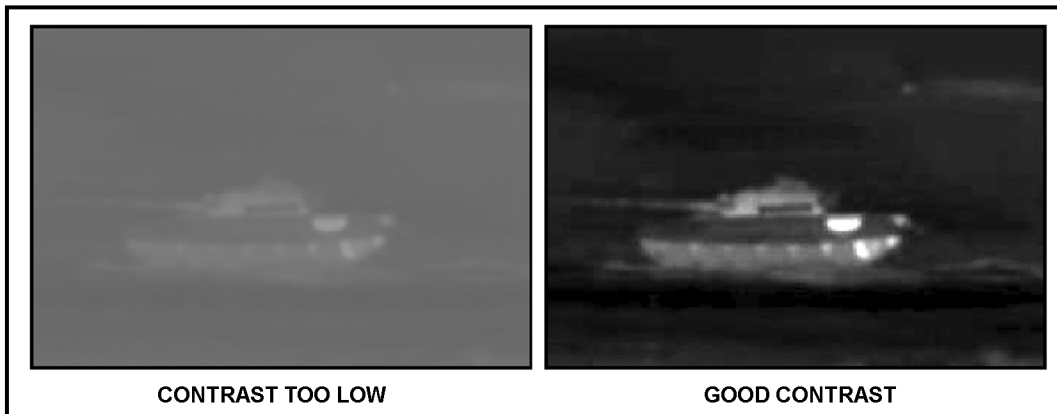
**NOTE:** Bright green objects in the TAS appear white in the figures used here. Objects that are shades of green in the TAS appear in shades of gray in the figures.

- When the contrast is too high (Figure C-19, page C-14), all objects are adjusted away from the shades of green in the middle toward the two extremes, so they appear either bright green or black. The gunner decreases the contrast by selecting CTRS on the BCF menu and pressing the BCF switch down. This decrease brings objects back from the two extremes into the shades of green.



**Figure C-19. High versus good contrast adjustments.**

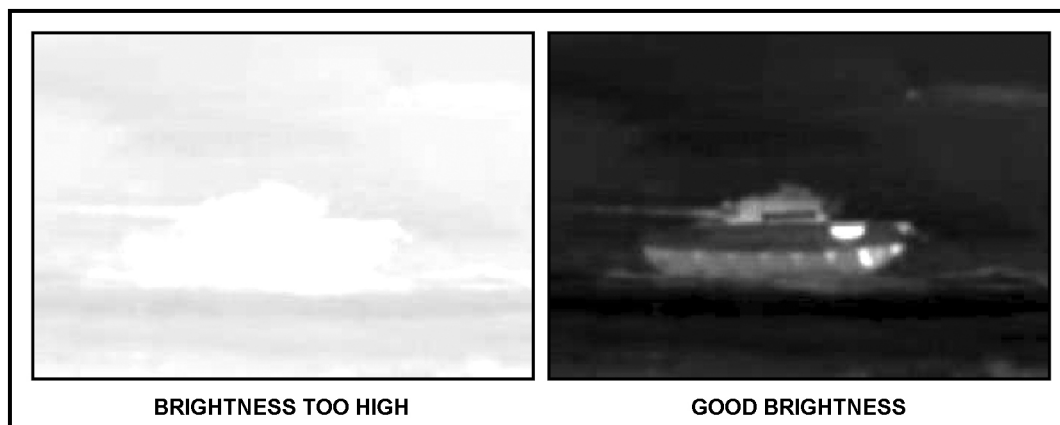
- When contrast is too low (Figure C-20), all objects are adjusted into the shades of green in the middle away from the two extremes, so nothing appears black or bright green. The gunner increases the contrast by selecting CTRS on the BCF menu and pressing the BCF switch up. This increase spreads the objects out from the middle shades of green back toward the extremes of bright green and black.



**Figure C-20. Low versus good contrast adjustments.**

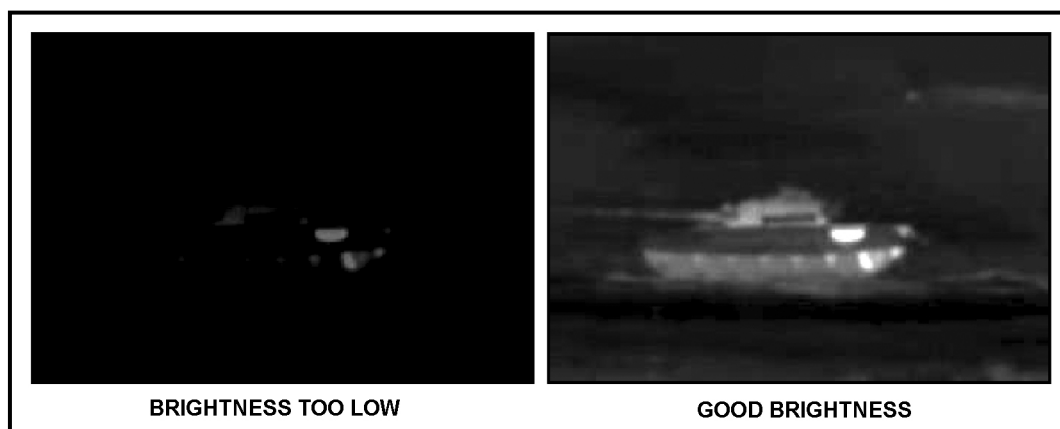
(d) *Brightness Adjustment.* Adjusting the brightness changes the intensity, or brightness, of the objects in a target scene in the same direction. Increasing brightness makes all objects brighter and decreasing it makes them darker.

- When the brightness is too high (Figure C-21), most objects in the target scene appear bright green, a few appear in shades of green, and none are black. The gunner decreases the brightness by selecting BRT on the BCF menu and pressing the BCF switch down. This decrease drives down the intensity of all objects until some of them appear black.



**Figure C-21. High versus good brightness adjustments.**

- When brightness is too low (Figure C-22), most objects appear black, a few appear as shades of green, and none appear bright green. The gunner increases the contrast by selecting BRT on the BCF menu and pressing the BCF switch up. This increase drives up the intensity of all objects until some areas appear bright green.



**Figure C-22. Low versus good contrast adjustments.**

#### **C-4. FACTORS THAT AFFECT INFRARED TARGET IMAGES AND DELTA-Ts**

Conditions that affect the gunner's ability to acquire a target include limited visibility conditions, solar heating, human activity, and range to the target.

a. **Limited Visibility Conditions (Natural and Man-Made).** Rain, snow, sleet, fog, haze, smoke, dust, and darkness are referred to collectively as limited visibility conditions.

(1) These conditions affect the gunner's ability to acquire and engage targets with the ITAS, especially when using day FOV. The gunner uses the NVS to overcome darkness, haze, and some smoke systems.

(2) The NVS can see through low levels of these obscurants better than the daysight. Its capability is restricted at higher levels of obscurations. The effect on the NVS image is a decrease in contrast.

b. **Solar Heating.** Solar heating is the single greatest influence on the target scene Delta-T changes. Solar heating also causes IR clutter and IR crossover, both of which can restrict the gunner's ability to engage a target.

(1) **Weather.** Weather can greatly change the amount of solar heat on objects. Objects observed during clear weather have good Delta-Ts due to the high amount of solar heating. In addition, the objects can change their appearance during a 24-hour period. During periods of precipitation (snow, rain, sleet, and so forth), there is little solar heating and the Delta-Ts are low.

(2) **Infrared Clutter.** Infrared clutter is a term used to describe a pattern of Delta-Ts in the target scene that prevents the gunner from distinguishing a target from its background. This pattern is similar to the effect that is attempted when a soldier wears the battle dress uniform (BDU). The BDUs have a certain color pattern to blend with the background, cluttering the gunner's outline and making it difficult for an enemy to see him. Infrared clutter can be natural or man-made. Differences between the two include cause or origin, effect on the target scene, area of coverage, time and location of appearance, and temperature of the clutter objects relative to the target.

(a) The sun creates natural IR clutter, which generally covers large areas of terrain, such as a field, scattered rocks, or a hillside, creating a disadvantage when trying to engage a target. (This clutter can prevent the gunner from seeing a target and its movement with the NVS, but not with the daysight.) Natural clutter is unpredictable, so the gunner cannot tell if or when the target is visible. The gunner must pay attention to areas of clutter so he can keep track of moving targets that enter these areas. Although natural IR clutter can prevent the gunner from seeing the target, it usually occurs during the day when the daysight works well for surveillance. However, if he cannot see the target with the NVS, the gunner will not be able to see it with the seeker either. Natural clutter is caused either by solar heating or by IR reflecting off objects in the target scene.

- When solar heating causes clutter, the clutter stays in the same place and keeps the same appearance for a long time. Delta-Ts are present in the target and in the background, but the two Delta-T patterns match so closely that the gunner may not be able to distinguish the target from the background. In addition, the range of temperatures in the clutter is the same as those in the target. To correct, the gunner first adjusts the contrast and the brightness. If the contrast and brightness adjustments do not distinguish the target from its background, the gunner must wait for the target to move out of the clutter or wait for the Delta-Ts to change.
- When reflected IR causes clutter, the clutter comes and goes randomly with the appearance of the sun, and at different locations. (This can cause the gunner to suddenly lose a target that was visible or make a target appear suddenly that was hidden from him.) Its appearance is such that the target and the clutter look like one large area of uniform temperature. Generally, a gunner can defeat this type of clutter by increasing the contrast and decreasing the brightness. If not, he must wait for the target to move out of the clutter or wait for the Delta-Ts to change.

(b) Man-made clutter occurs when conditions exist that are influenced by human activity that affects objects in the target scene. A target being in an area that has flames (burning vehicles or buildings) can work for the gunner and, at the same time, against him. An enemy vehicle may be able to use the flames to hide, making it difficult for the seeker to obtain a lock-on. However, based on the Delta-Ts, the gunner may be able to detect the target. To achieve this, the gunner must change the contrast and brightness based on the appearance of the target. He starts by adjusting the brightness first, then the contrast until he has a good target scene. Although the gunner may be able to counter the effects of IR clutter in the NVS (WFOV or NFOV) by adjusting the contrast and brightness, he may not be able to see the target in seeker FOV. If the corrective action does not work on the target scene and allow the gunner to acquire the target, he should—

- Wait for the target to leave the area of IR clutter.
- Wait for the target to change in temperature, then try to engage the target.
- Wait for the objects causing the IR clutter to change in temperature, then try to engage the target.

(c) Infrared crossover prevents the gunner from seeing the target because everything in the target scene (the background terrain and the target) is about the same temperature. This occurs twice in a 24-hour period—at dawn and again at dusk. During these times, the target is nearly the same temperature as its background, so the Delta-T between the target and its background is low (Figures C-23). The ITAS detects Delta-Ts as low as 1 degree Fahrenheit. The gunner can overcome the effects of crossover by adjusting contrast and brightness. In addition, crossover will not occur for all parts of the target at the same time. Part of the target will always have a measurable Delta-T between it and the background so the gunner can determine the target's location.

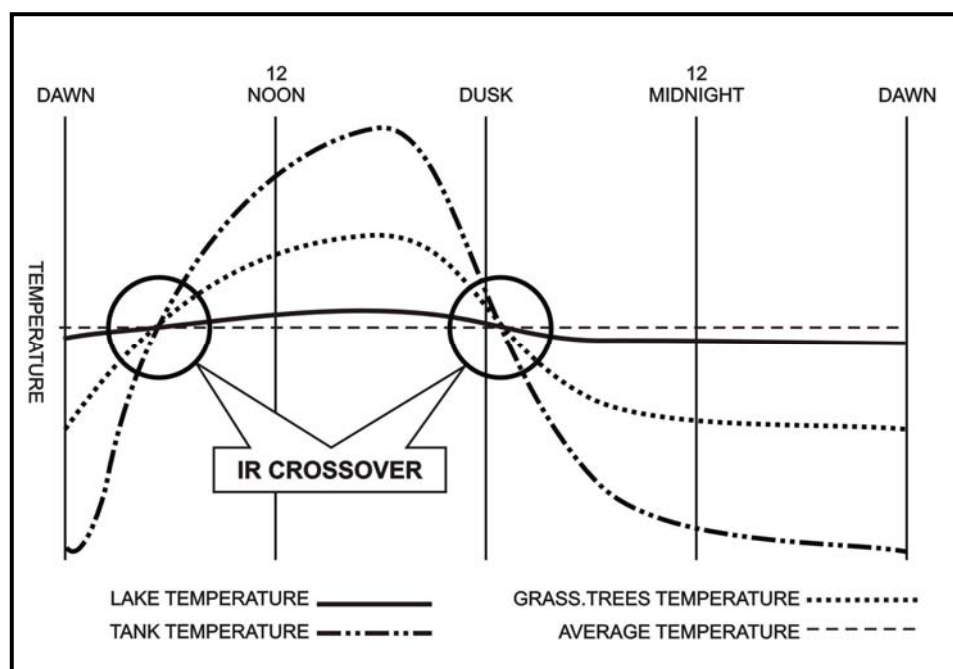


Figure C-23. IR crossover times.

c. **Human Activity.** Human activity also affects the amount of IR in objects in the target scene, which disrupts the natural changes that should occur in their IR images. For example, vehicles and asphalt roads should appear dark green at night. When a vehicle is driven for a while, it appears bright green around the engine, exhaust, and suspension as a direct result of human activity. When enough vehicles drive on a road, the road will appear as light green where wheel or track friction causes the road surface temperature to increase (Figure C-24).



**Figure C-24. Road temperature increases due to friction from vehicle tracks.**

**NOTE:** Thermal signatures, as shown in Figure C-24, may not appear the same in actual field or combat conditions where road wheels and vehicle silhouettes may be partially obscured or degraded due to hull-down positions, terrain masking, natural vegetation, and so on.

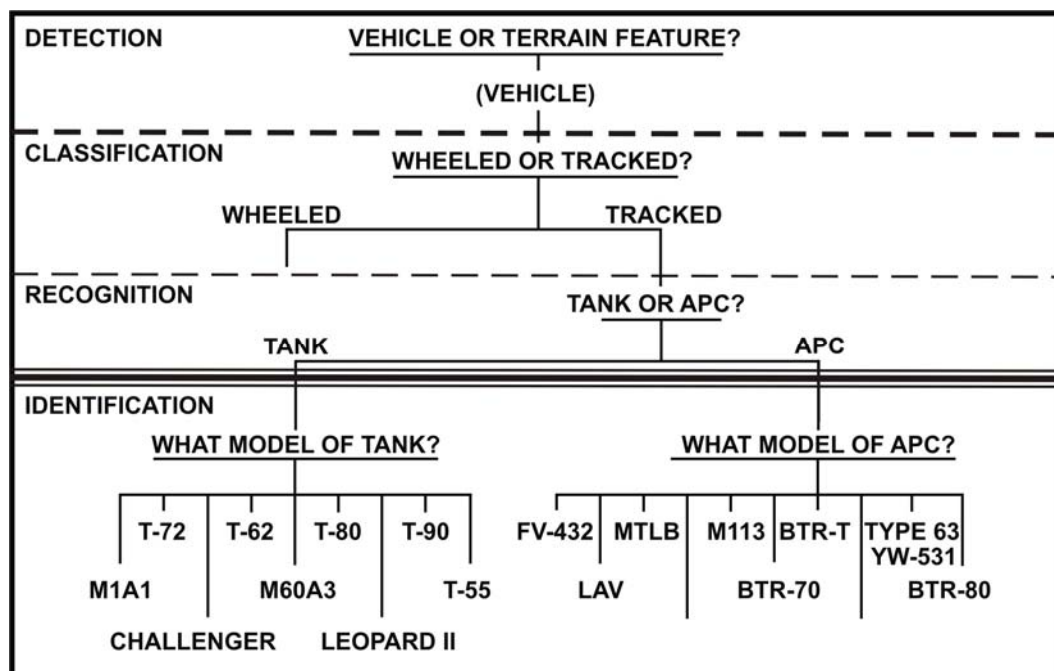
d. **Range to Target.** The gunner's ability to distinguish a target at maximum range from its background is restricted due to limitations of the NVS magnification, image resolution, and obscurants. When the target moves toward the gunner, the clarity of target details increases as range to the target decreases. The gunner can use the ZOOM in the NVS to see targets at long ranges.

#### **C-5. TARGET ACQUISITION**

Target acquisition consists of target detection, classification, recognition, and identification (Figure C-25). Each step has a specific field of view associated with it. These FOV steps allow the gunner to progress efficiently into target engagement. The first three steps are discussed in the target acquisition process only. Target identification is taught at the unit level. Various media is available to assist the unit in this training.



**NOTE:** Foreign tanks may be equipped with devices to focus engine exhaust down and to one side of the vehicle causing a different and unexpected hot spot.



**Figure C-25. Target acquisition steps.**

a. **Field of View Sequence.** As the gunner detects, classifies, and recognizes a target, then determines its engageability, he must change the field of view as the task requires.

(1) **Day Field of View.** Day FOV provides a full-color, visible-light target image. Day FOV imagery is only useful during daylight hours with clear weather. The gunner should use it primarily during NVS cool down or when the IR conditions make it difficult to see the target in the NVS. The day FOV has a wide and narrow field of view.

(a) **Wide Field of View.** WFOV provides 4.2x magnification of the target scene. It is ideal for use during surveillance and target detection due to its large area of coverage. The low magnification means the gunner cannot see the target details very well, which makes it a poor tool for target classification, recognition, and identification.

(b) **Narrow Field of View.** NFOV provides about 9x magnification of the target scene. Its higher magnification is useful for seeing target details for target classification, recognition, and identification. At the same time, the restricted area of coverage makes it difficult to use for target detection.

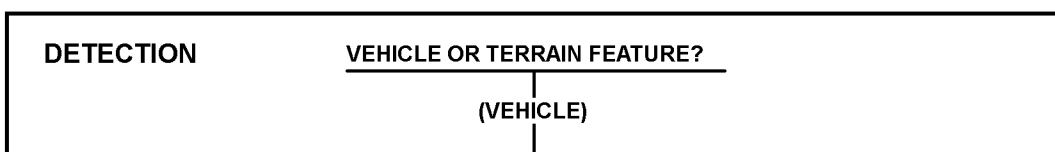
(2) **Night Vision Sight.** The NVS provides two fields of view: WFOV and NFOV. Both provide IR images and zoom capability and can be used at any time of day under any weather conditions. The NVS is the gunner's primary sight.

(a) **Wide Field of View.** WFOV provides 4x magnification of the target scene. It is ideal for use during surveillance and target detection due to its large area of coverage. The low magnification means the gunner cannot see the target details very well, which makes it a poor tool for target classification, recognition, and identification.

(b) *Narrow Field of View*. NFOV provides about 12x magnification of the target scene. Its higher magnification is useful for seeing target details for target classification, recognition, and identification. At the same time, the restricted area of coverage makes it difficult to use for target detection.

(c) *Zoom*. Zoom doubles the magnification of the NVS when it is in surveillance mode. WFOV doubles from 4x to 8x magnification, and NFOV doubles from 12x to 24x magnification. Zoom is an excellent tool for target recognition and identification.

b. **Target Detection**. The first step in the target acquisition process is target detection (Figure C-26). During this step, the gunner scans his sector of fire to find or acquire a target using the TAS, mainly the NVS. Target detection describes the process by which the gunner visually locates and distinguishes the features of a vehicle from the surrounding terrain features. Some techniques that help detect targets are discussed below.



**Figure C-26. Target acquisition—detection.**

(1) **Scanning for Targets**. The gunner should—

(a) Scan the entire sector of fire using WFOV.

(b) Scan slowly and steadily in a consistent, systematic pattern.

(c) Pay special attention to those positions in which a target might appear.

(d) Identify the location of objects, such as TRPs, trees, roads, buildings, and previously killed targets, that have a distinct IR signature. This enables the gunner to quickly locate targets in his sector of fire.

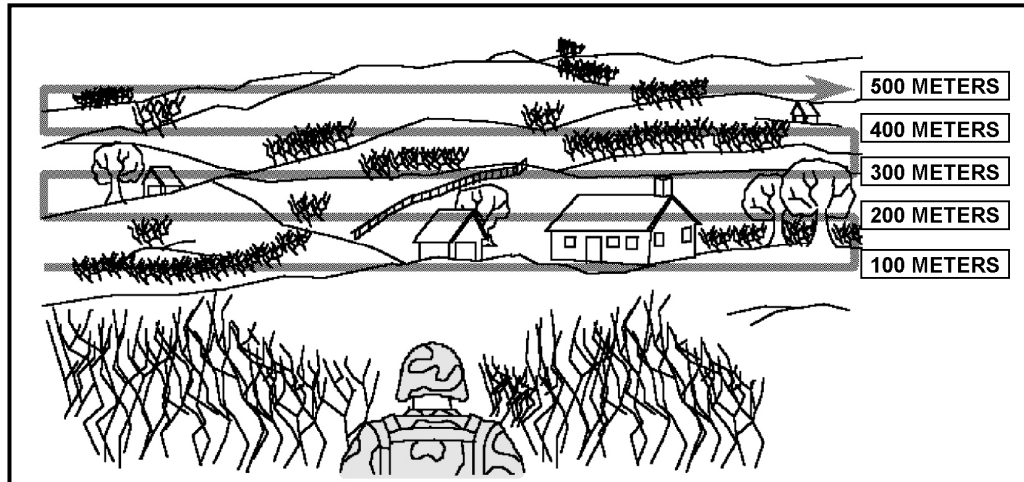
(e) Look for man-made shapes that have straight lines and block angles.

(2) **Scanning Techniques**. The gunner scans his sector of fire continuously using rapid scan, slow scan, and detailed search.

(a) **Rapid Scan** (Figure C-27). Rapid scan is used to detect obvious signs of enemy activity. It is usually the first method the gunner uses. To conduct a rapid scan, do the following:

- Search a strip of terrain about 100 meters deep from left to right, pausing at short intervals.
- Search another 100-meter strip farther out from right to left overlapping the first strip scanned and pausing at short intervals.
- Continue this method until the entire sector of fire has been searched.

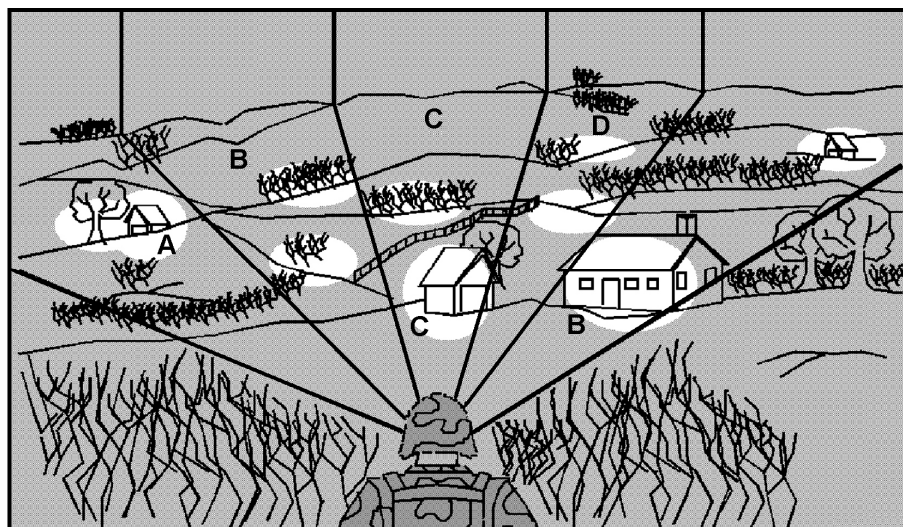
(b) **Slow Scan**. The slow scan search technique uses the same process as the rapid scan but much more deliberately, which means a slower side-to-side movement and more frequent pauses. When a possible target has been detected, the gunner stops and searches the immediate area thoroughly using the detailed search.



**Figure C-27. Rapid/slow scan pattern.**

(3) **Detailed Search.** If the gunner finds no targets using either the rapid or slow scan techniques, he makes a careful, detailed search of the target area using NFOV (Figure C-28). The detailed search is like the slow scan, but searches smaller areas with frequent pauses and almost incremental movement. The detailed search, even more than the rapid or slow scan, depends on breaking a larger sector into smaller sectors to ensure everything is covered in detail and no possible enemy positions are overlooked. When the gunner pauses to look at areas where targets could be hiding, he may also use the zoom to magnify details in that area.

- Concentrate on likely vehicle positions and suspected armor avenues of approach.
- Look for target signatures around prominent terrain features such as road junctions, hills, and lone buildings. Also, look at areas with cover and concealment such as tree lines and draws.



**Figure C-28. Detailed search.**

c. **Defensive Operations (Moving Targets).** When trying to detect the enemy, the gunner should look and listen for signs of enemy presence.

(1) **Dust or Vehicle Exhaust.** Moving vehicles often raise dust. Stay alert for dust because it can be spotted at long ranges.

(2) **Vehicle Movement.** Look for enemy movement along high-speed avenues of approach. Search along terrain features that offer masking such as tree lines and draws.

(3) **Flashing Hot Spots.** As a vehicle moves over small gullies and hills at a distance, its hot spots appear to be flashing and appear to become visible, then invisible as the vehicle drops below the observation line.

(4) **Sounds.** Equipment or vehicle sounds can alert the gunner to the direction or general location of the enemy. These sounds may not pinpoint the enemy's exact location, but if a sound alerts the gunner to a general area, he is more likely to spot the enemy in that area using the detailed search technique.

(5) **Image Adjustment.** The gunner can spot moving targets easily due to the hot IR signatures from the suspension, engine compartment, and exhaust and due to the changes in the target aspect as the target moves in his sector of fire. When the gunner is in a defensive position, he adjusts the image so he can see all of the terrain features, which helps him locate any targets moving in his sector of fire.

d. **Offensive Operations (Stationary Targets).** During offensive operations, the gunner may encounter stationary targets. A stationary target is more difficult to detect than a moving target because it does not give away its location by moving, but can be partly or completely concealed by a terrain feature. Key IR signatures may be cold. Depending on how long the target has been stationary, the gunner may see hot, cold, or partly cool signatures. The IR image of a hot, stationary target is much easier to detect than that of a cold, stationary target. The gunner can augment his visual search to find an enemy emplacement. The difficulty in detecting a target is directly affected by the temperature of the surrounding terrain.

(1) **Sounds.** Listen for equipment and vehicle sounds.

(2) **Vehicle Exhaust.** Be alert to the presence of vehicle exhaust. Tanks need their engines started every few hours to charge the batteries, which creates a large plume of exhaust (Figure C-29) and a distinctive smell, which may linger even after the engine has been turned off.



**Figure C-29. Vehicle exhaust.**

(3) *Dismounted Troops* (Figure C-30). The human body is a good IR source and appears as a hot image. Watch for dismounted troop movement that can reveal the position of a mechanized force.



**Figure C-30. Dismounted troops as IR source.**

(4) *Vehicle Positions*. Look for enemy positions in obvious places such as road junctions, hilltops, and lone buildings. Observe areas with cover and concealment such as wood lines and draws.

(5) *Image adjustment*. The gunner may have to adjust the image several times to detect stationary targets due to various circumstances. He should and examine the following:

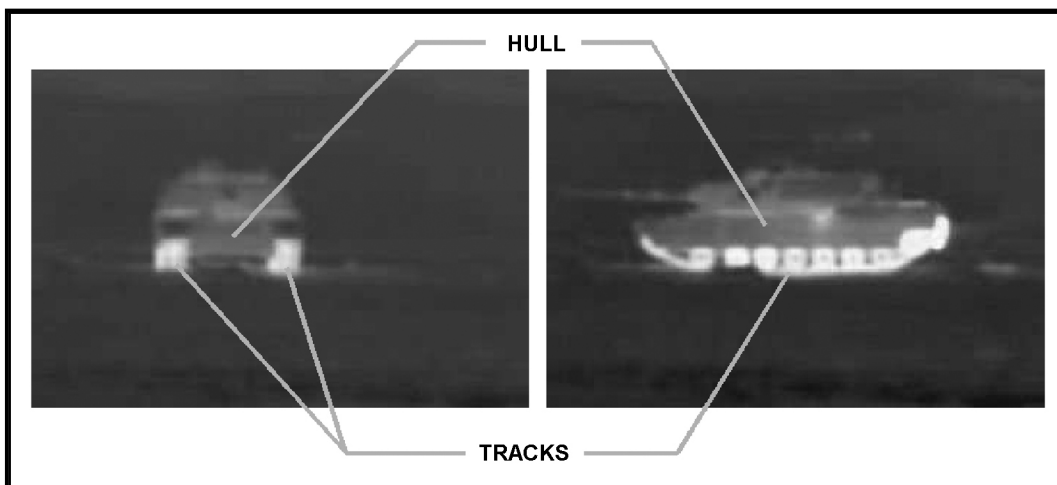
- In what aspect (frontal or flank) he sees the targets, which affects what IR signatures he is able to see.
- If the targets are partly hidden by a terrain feature, such as when it is in defilade or in a tree line.
- Whether targets are hot from recent activity or solar heating, partly cool due to reduced activity, or cold due to long inactivity.

e. **Hot Stationary Targets.** Hot stationary targets are the easiest to detect. When a stationary target has hot signatures, the gunner can assume there has been recent activity or solar heating. To find hot signatures easily, adjust contrast up and brightness down so that only the hottest signatures appear in the field of view, and the rest of the scene is black. When the gunner thinks he has detected a target, he adjusts the contrast and brightness so he can see the rest of the target's features. Depending on the target's exposure and aspect, some of the signatures to look for include the suspension system, engine compartment/exhaust, gun tube or barrel, and an indirect signature called backlighting.

(1) **Suspension System.** When a target has moved recently, its suspension presents a hot IR signature.

(a) The track area presents hot spots due to heating from friction.

(b) When viewed from the front, the tracks are normally visible as two IR signatures on either side of and below a larger dark area (the hull) (Figure C-31). If viewed from the flank, the tracks and road wheels normally are visible as a hot signature beneath a larger dark area (the hull).



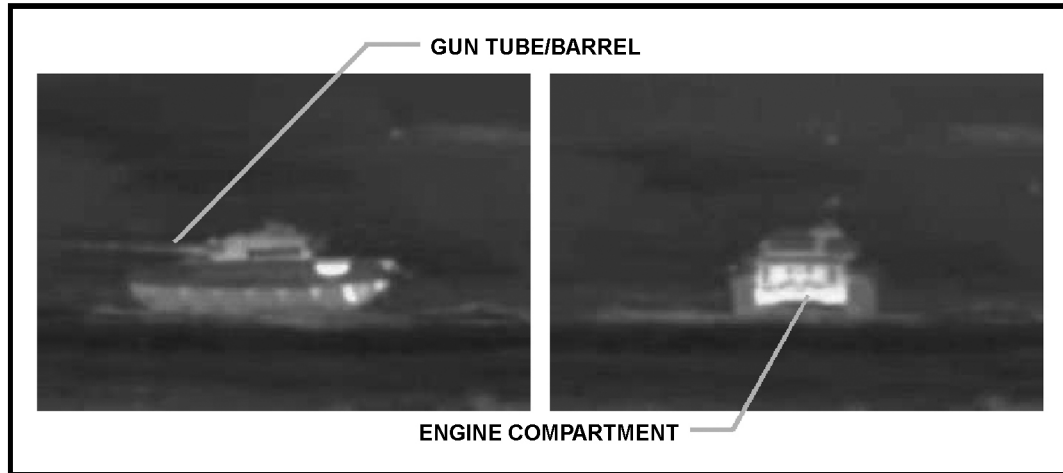
**Figure C-31. Track and hull signatures.**

(2) **Engine Compartment (C-32).** The engine compartment is usually a reliable IR signature for the following reasons:

(a) Due to the extreme heat generated by the engine and the large mass of metal of which it is made, a stationary vehicle's engine compartment gives off a hot IR signature for several hours after the vehicle is stopped. The engine takes longer to cool than the rest of the hull.

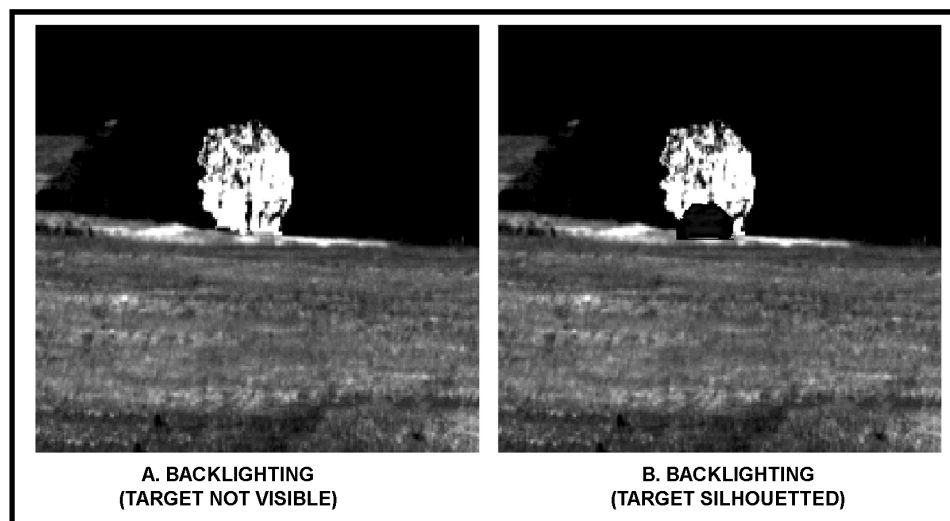
(b) A stationary vehicle engine must be started after long periods of inactivity to keep its battery charged. This situation keeps the IR image hot.

(3) **Gun Tube/Barrel.** The gun tube or barrel is another area to look for heat (Figure C-32). When the gun has been fired recently, it appears hotter than its background.



**Figure C-32. Engine compartment and gun tube/barrel.**

(4) **Backlighting.** Backlighting is an indirect IR signature that indicates the presence of a target. It is called an *indirect IR signature* because, though it is not physically part of the target, it is caused by heat from the target—usually, from the exhaust. Backlighting occurs when an IR source, such as a tank's exhaust, emits IR, which reflects off another object such as a tree. Even though the gunner may not see a vehicle, backlighting warns him of its presence (Figure C-33A). When the target is between the gunner and the backlighting, the target may appear as a silhouette (Figure C-33B).

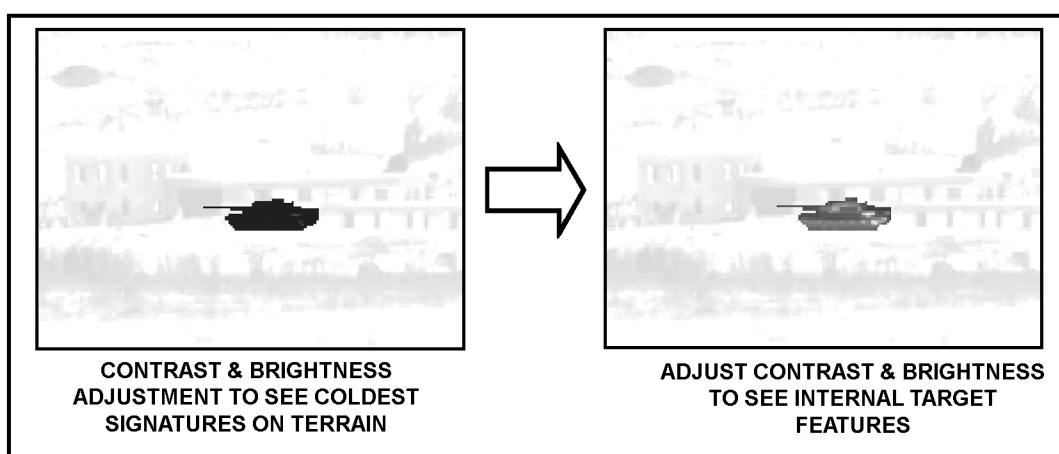


**Figure C-33. Backlighting.**

f. **Cold Stationary Targets.** When the gunner sees a cold stationary target, he can assume there has been no recent activity. (While the absence of heat likely indicates an absence of activity, it is possible that the tank may be using a remotely located generator for power to deceive U.S. thermal imaging systems.) A cold target is cooler than its background. It appears as a dark green or black image against a lighter green background. Look for an IR signature that resembles a silhouette of a wheeled or tracked vehicle (Figure C-34).

(1) To find cold targets easily, adjust contrast and brightness up so only the coldest signatures appear in the gunner's field of view and the rest of the scene is bright green.

(2) When the gunner thinks he has detected a target, he adjusts the contrast and the brightness so he can see the rest of the target's features.



**Figure C-34. Image adjustment for detecting cold, stationary targets.**

g. **Partially Cool Stationary Targets.** When stationary targets are partially cooled, the gunner can assume there has been some activity. Partially cool stationary targets are especially difficult to detect because their signatures are closer to the same temperature as the surrounding terrain. Their signatures also become distorted and incomplete as they cool. This procedure causes the signatures to blend with the background. To find partially cool targets, the gunner has to adjust the contrast and the brightness in various combinations while he scans his sector of fire.

h. **Hull Defilade Targets (Tanks).** Hull defilade targets are the most difficult to detect because they are not visible at all times. When a tank is in defilade, it moves back-and-forth between a firing platform and its hide position.

(1) **Firing Platform Position** (A, Figure C-35). The tank stays on the firing platform long enough to fire its main gun. During the short period of time that it is in this position, the gunner sees only the turret and gun tube. As soon as the tank fires, it moves to its hide position.

(2) **Hide Position** (B, Figure C-35). When a tank is in its hide position, the gunner cannot see the target, but he may be able to see the tank commander's head.



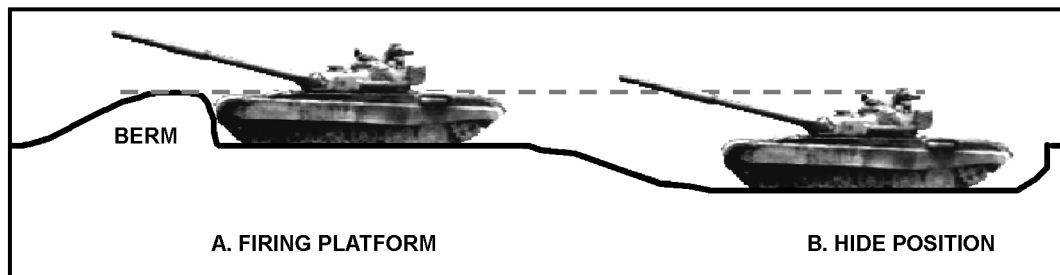


Figure C-35. Tank in defilade.

## C-6. TARGET CLASSIFICATION

Once the gunner detects a potential target, he begins the process of elimination to determine the target's classification (Figure C-36).

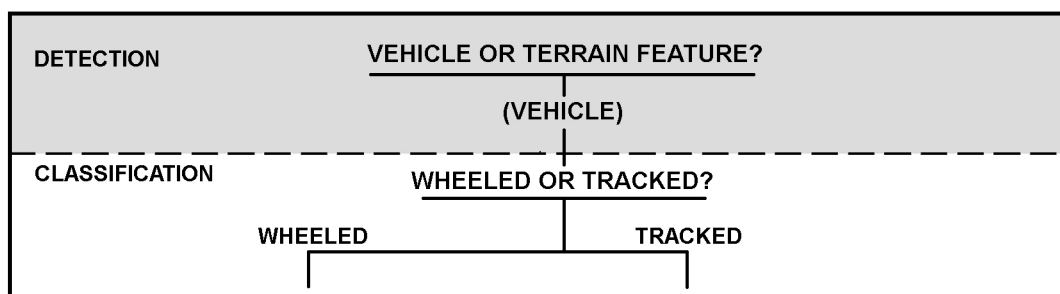


Figure C-36. Target acquisition process—classification step.

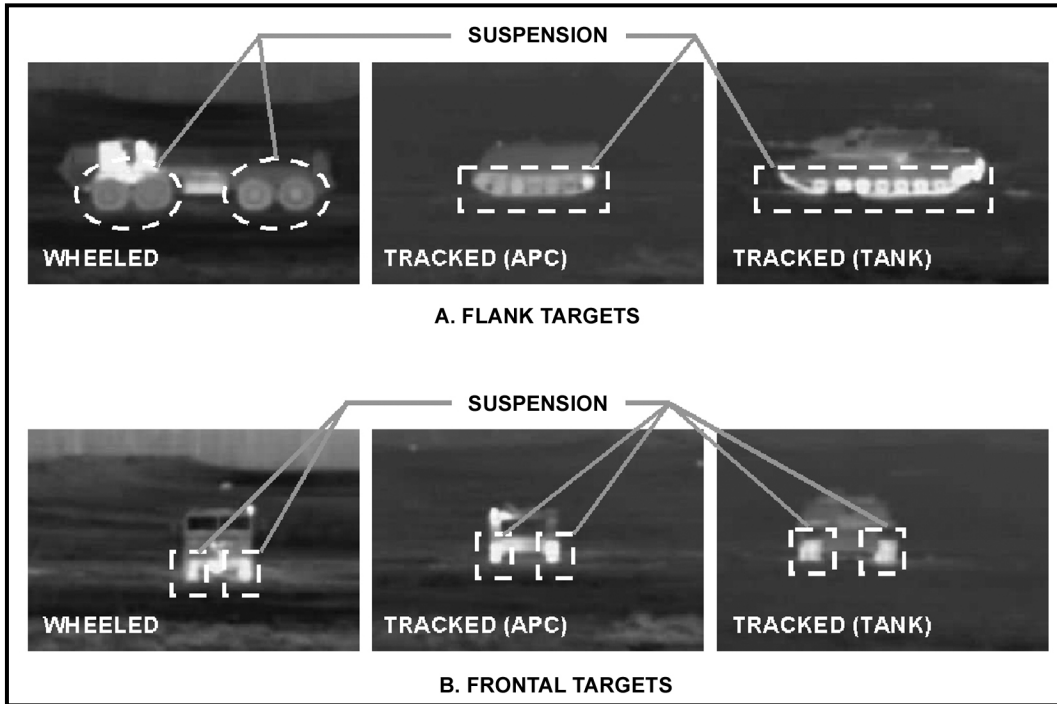
a. **Classification Features.** There are specific features that the gunner looks for to classify a vehicle. These features include the suspension system, location of the engine compartment, and presence of a gun tube. Whether or not a feature is visible depends on the target aspect (frontal or flank).

(1) **Suspension System.** The type of suspension system defines the target's classification.

(a) **Wheeled Vehicle (Flank).** A wheeled vehicle has two to five round hot spots at its base that appear large compared to the rest of the vehicle (A, Figure C-37, page C-28).

(b) **Tracked Vehicle (Flank).** A tracked vehicle has five to seven round hot spots created by the road wheels that look small compared to the rest of the vehicle. The tracks may be visible, and depending on the vehicle configuration, the gunner may see return rollers or skirts (A, Figure C-37, page C-28).

(c) **Wheeled and Tracked Vehicles (Frontal).** On frontal targets, the suspensions for wheeled and tracked vehicles look similar in the NVS (B, Figure C-37, page C-28).

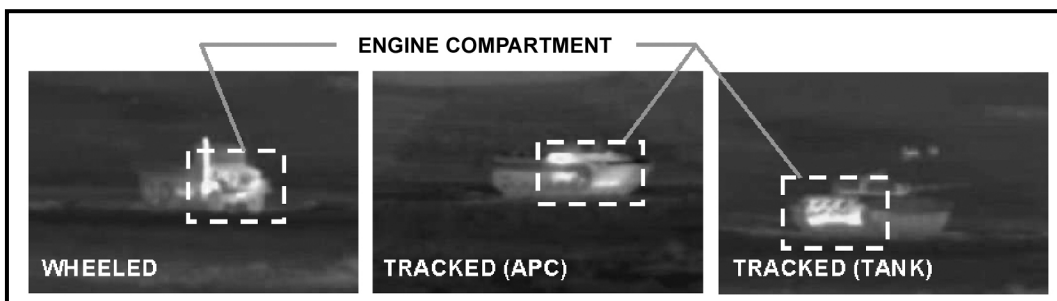


**Figure C-37. Classification features—suspension system.**

(2) **Engine Compartment** (Figure C-38). The location of the engine compartment helps determine the target's classification.

(a) **Wheeled Vehicles.** Generally, the engine on a wheeled vehicle is located at the front.

(b) **Tracked Vehicles.** The location of the engine on a tracked vehicle depends on whether the vehicle is a tank or an APC. Tanks have engine compartments located at the rear. APCs generally have engine compartments located at the front.

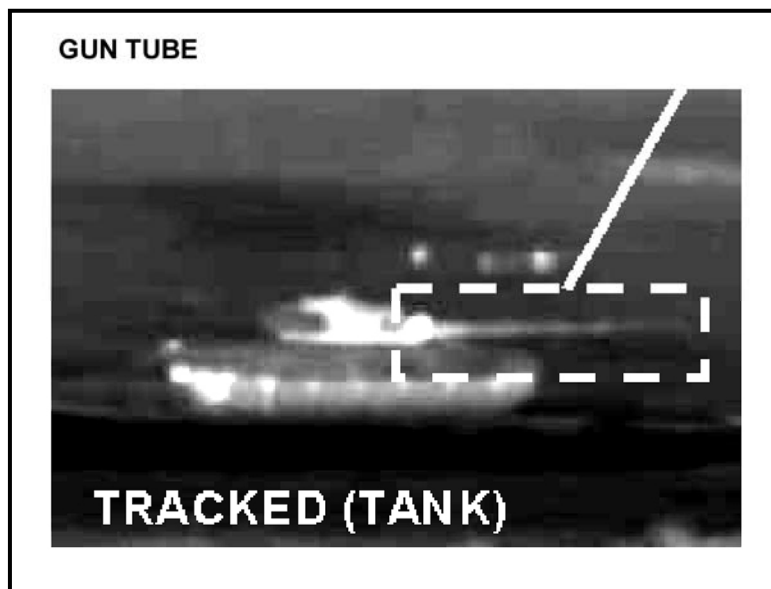


**Figure C-38. Classification features—engine compartment location.**

(3) **Gun Tube/Barrel.** When a gun tube or barrel is mounted on a turret or cupola, the TOW gunner may or may not be able to see it, depending on turret orientation.

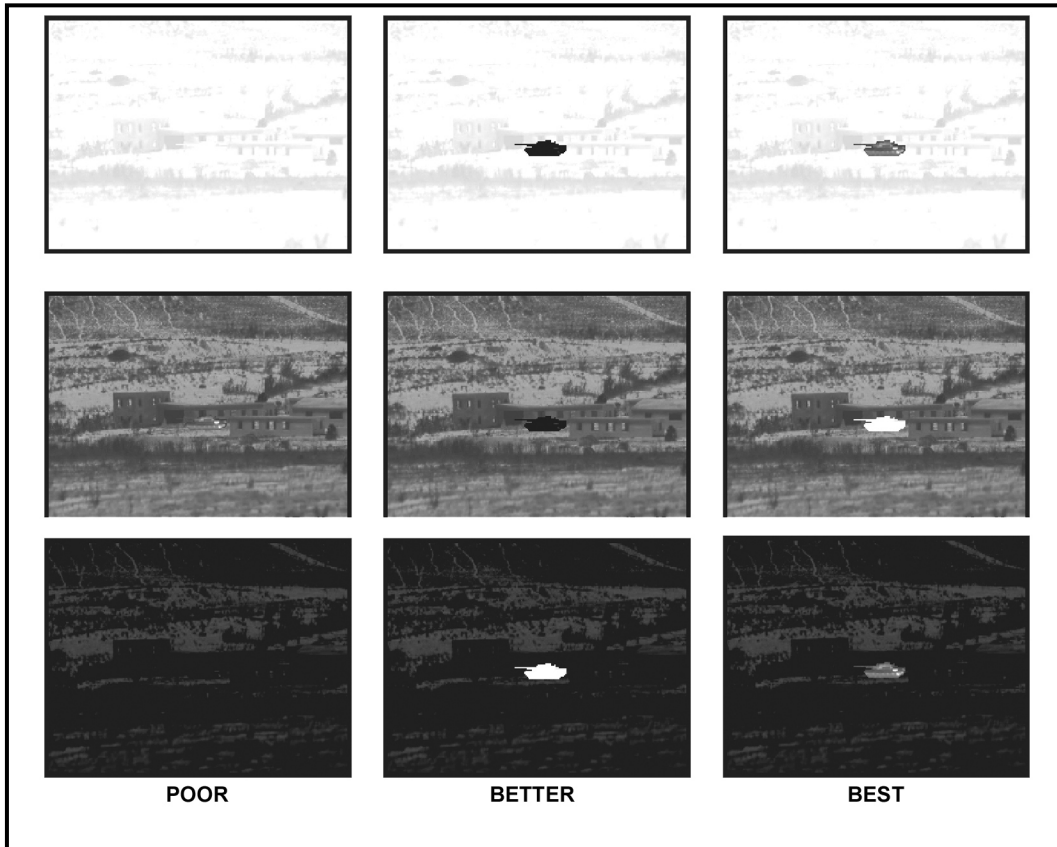
(a) **Wheeled Vehicle.** In most cases, wheeled vehicles do not have a gun tube, but they may have some type of smaller support gun (machine gun) mounted.

(b) *Tracked Vehicle*. When the turret is oriented to the proper angle, the gun tube signature stands out from the turret (Figure C-39).



**Figure C-39. Classification features—gun tube/barrel.**

**NOTE:** Proper adjustment of focus, contrast, and brightness enables the gunner to classify and recognize targets. Adjust the image so the target features stand out from the surrounding terrain features. It may be necessary to make several adjustments for the same target. Figure C-40 (page C-30) shows examples of poorly adjusted and properly adjusted target images for classification and recognition.

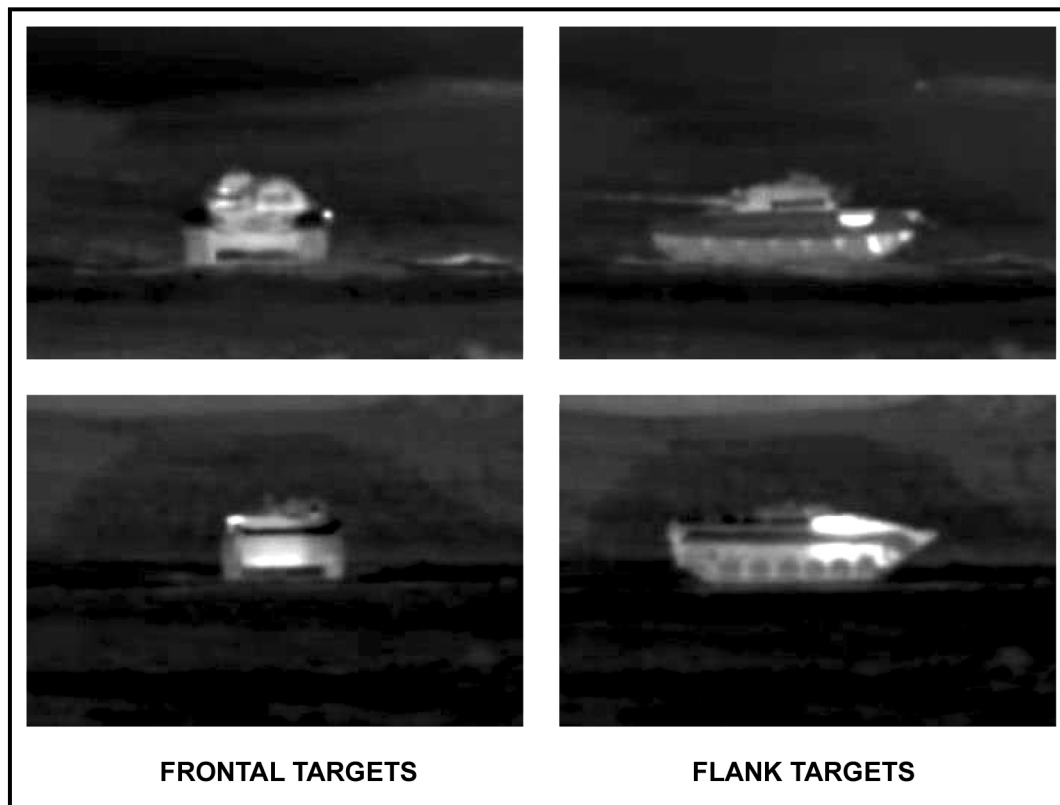


**Figure C-40. Image adjustments for target classification and recognition.**

b. **Defensive Operations (Moving Targets).** Some targets may be easier to classify and recognize than others for the following reasons:

(1) **Range to the Target.** Even under ideal conditions, classifying and recognizing a target at long ranges is difficult due to the NVS magnification and image resolution. As range to the target decreases, target details become clearer, which makes classification and recognition easier.

(2) **Target Aspect.** Flank targets are easier to classify and recognize than frontal targets (Figure C-41). The profile exposes the suspension and other distinctive features, such as turrets, engine compartments, gun tubes, or other armament.



**Figure C-41. Classification and recognition features of flank versus frontal target.**

(3) **Target Movement.** A moving target allows the gunner to see it from more than one aspect making it easier to classify and recognize than a frontal target moving in a straight line.

(4) **Terrain.** Targets try to remain hidden from the gunner by staying in cover and concealment, or by using the terrain to mask their movement. Depending on the amount of terrain masking, the gunner may see only one or two features from which to classify and recognize a target.

c. **Offensive Operations (Stationary Targets).** The gunner's ability to detect, classify, and recognize a stationary target depends on:

- Position of the target with respect to the gunner's location.
- Enemy activity.
- Proper image adjustment.
- Amount of target exposure.

## C-7. TARGET RECOGNITION

Target recognition is the next step in the process of determining whether a tracked vehicle is a tank or an APC (Figure C-42, page C-32).

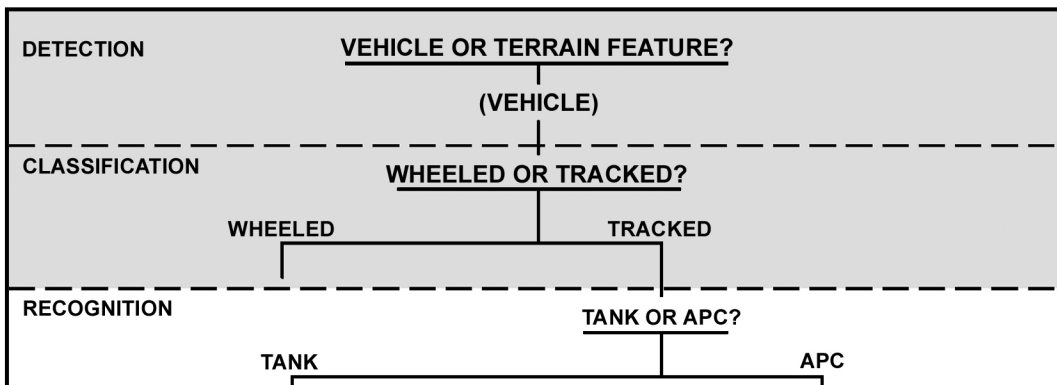


Figure C-42. Target acquisition process—recognition step.

a. **Image Adjustment.** Image adjustment for target recognition is the same as for classification. The gunner should make image adjustments so the target features stand out from the surrounding terrain features. The gunner may have to keep adjusting contrast and brightness to bring out different target details.

b. **Recognition Features.** The major differences between tanks and APCs are shown in Figure C-43 and Table C-1:

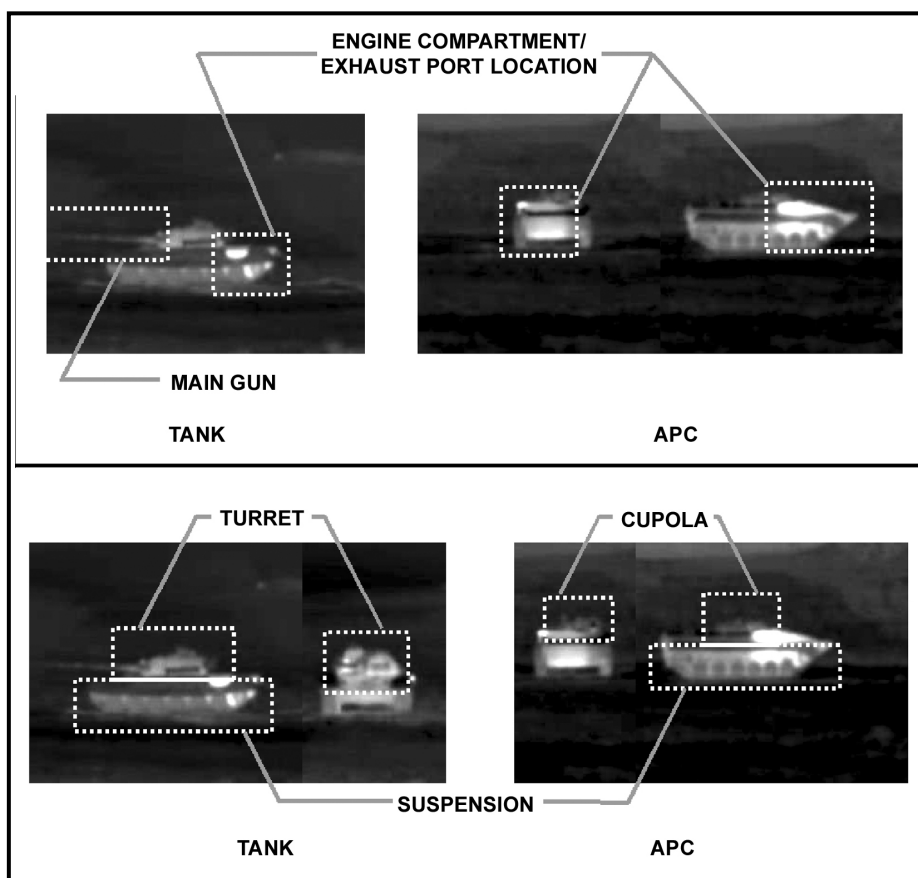


Figure C-43. Target recognition features

<b>SIGNATURE</b>	<b>TANK</b>	<b>APC</b>
ENGINE COMPARTMENT	LOCATED IN REAR	LOCATED IN FRONT
EXHAUST PORTS	LOCATED IN REAR	LOCATED IN FRONT OR ON THE SIDE
MAIN GUN	LONG AND THICK	SHORT AND THIN
TURRET	YES - AND LARGE	YES, MOST HAVE TURRETS
CUPOLA	NEW TANKS—NO OLD TANKS—YES	YES—USUALLY SMALL
SIZE/SHAPE	LARGE AND SLOPING	SMALL AND RECTANGULAR

**Table C-1. Target recognition features.**

### **C-8. TARGET IDENTIFICATION**

Enough information may be available to engage a target after the gunner has detected, classified, and recognized it, but the final step in target acquisition is identification. The enemy may have armored vehicles common to our allies, and the gunner must be sure of his target. The ITAS provides the gunner with a thermal image of a target; therefore, the gunner must have a clear understanding of thermal vehicle signatures as well as daylight images. Training aids available to the units come in different forms from CD-ROM and graphic training aids (GTAs) to actual photographs. These tools prepare the gunner to correctly identify enemy vehicles versus friendly ones.

a. The Recognition of Combat-Vehicles (ROC-V) CD-ROM is available from the Night Vision and Electronic Sensors Directorate, PM-FLIR. This directorate can be contacted for assistance in vehicle identification at ROC-V@nvl.army.mil.

b. Graphic training aids 17-2-11 and 17-2-13 (available through the local TSC) provide the gunner with line drawings and pictures of friendly and enemy vehicles.

c. Jane's Defense Combat Armored Vehicle Identification contains pictures and descriptions of most armored vehicles currently in service throughout the world.

**This page intentionally left blank.**



## APPENDIX D ANTIARMOR RANGE CARD

*The range card is a sketch of a gunner's assigned sector of fire. It contains information that helps in planning and controlling fires, in detecting and engaging targets, and in orienting replacement personnel. Using range cards allows a gunner or a replacement gunner to find and engage targets quickly. The standard range card (FM 7-8) is slightly modified when employing an antiarmor weapons system. This appendix outlines how to prepare an antiarmor range card.*

### D-1. DESCRIPTION

A DA Form 5517-R, (Standard Range Card), is a record of the firing data for a weapon system on a given sector of fire. This record facilitates target engagement during good or limited visibility conditions. It is divided into three sections (Figure D-1): marginal information, sector sketch section, and data section.

The diagram shows a 'STANDARD RANGE CARD' form. It is divided into three main sections indicated by arrows on the left:

- Marginal Information:** The top section containing:
  - SQD \_\_\_\_\_
  - PLT \_\_\_\_\_
  - CO \_\_\_\_\_
  - May be used for all types of direct fire weapons.
  - MAGNETIC NORTH
- Sector Sketch Section:** The middle section featuring a semi-circular grid of concentric arcs centered on a dot, used for sketching the firing sector.
- Data Section:** The bottom section containing:
  - POSITION IDENTIFICATION \_\_\_\_\_ DATE \_\_\_\_\_
  - WEAPON \_\_\_\_\_ EACH CIRCLE EQUALS \_\_\_\_\_ METERS \_\_\_\_\_
  - A table with columns: NO., DIRECTION/DEFLECTION, ELEVATION, RANGE, AMMO, and DESCRIPTION.
  - REMARKS: \_\_\_\_\_

DA FORM 5517-R, FEB 86

Figure D-1. Three sections of a range card (DA Form 5517-R).

## D-2. GENERAL PROCEDURES

Before a gunner can prepare a range card, he must have certain information provided to him. The leader usually briefs the gunner on that information (Figure D-2) including:

- Firing position.
- Left and right limits of fire.
- Maximum engagement line (MEL).
- Avenues of approach (AAs).
- Target reference points (TRPs).

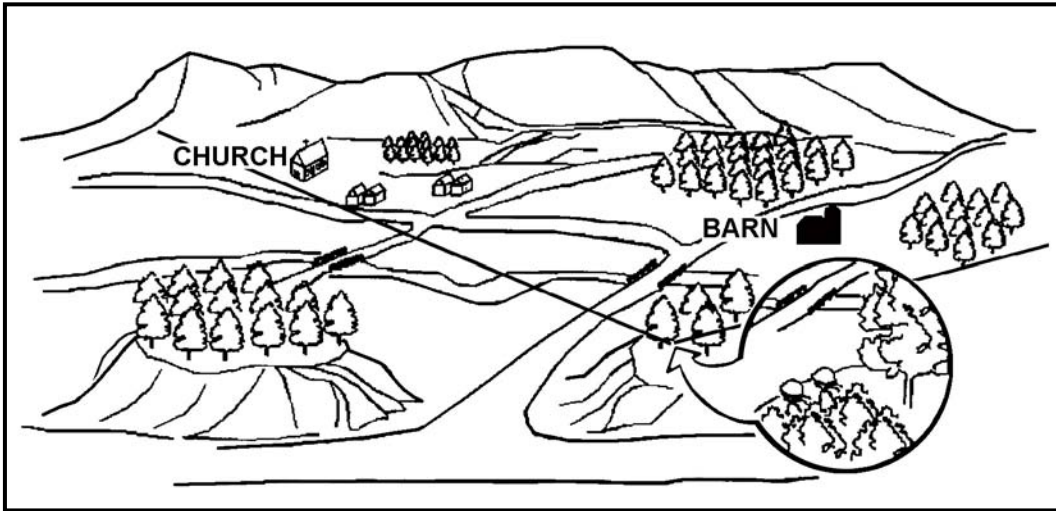


Figure D-2. Gunner's sector of fire.

### EXAMPLE OF A SECTION LEADER BRIEFING A GUNNER

"I want you to cover a sector of fire that begins here at your firing position and goes to a point about 500 meters beyond that church on the left, moves to the right along the high ground at 200 meters behind the houses, through the wood line, behind the hill, barn and orchard until it reaches a point about 300 meters beyond the right leading edge of the orchard, and returns to your firing position. The enemy is approaching from the north so they will probably use those two roads to enter your sector. Plan to engage the enemy's armor as soon as it comes within range on the road behind the barn and orchard. Engage the enemy targets as soon as they appear on the second road as they approach from the left side of that large hill. There are two target reference points within your sector so copy them down: the church is TRP AB1670 and the barn is TRP AB1677."

## D-3. MARGINAL INFORMATION

Use the following procedures to complete the marginal information at the top of the range card (Figure D-3).

- a. **Magnetic North.** Orient the range card with the assigned sector of fire. Use a lensatic compass to determine magnetic north. Keeping the range card oriented to the sector of fire, draw the magnetic north symbol in the appropriate direction in the magnetic north box.
- b. **Unit Description.** Use squad, platoon, and company designations. Do not list any designation for units higher than company level (Figure D-3).

<b>STANDARD RANGE CARD</b>		
<small>For use of this form see FM 7-8. The proponent agency is TRADOC.</small>		
SQD <u>1</u> PLT <u>3</u> CO <u>A</u>	May be used for all types of direct fire weapons.	<div style="font-size: 2em; font-weight: bold;">1</div> MAGNETIC NORTH

**Figure D-3. Example of marginal information.**

#### **D-4. CALCULATE**

Calculate the number of meters each circle represents.

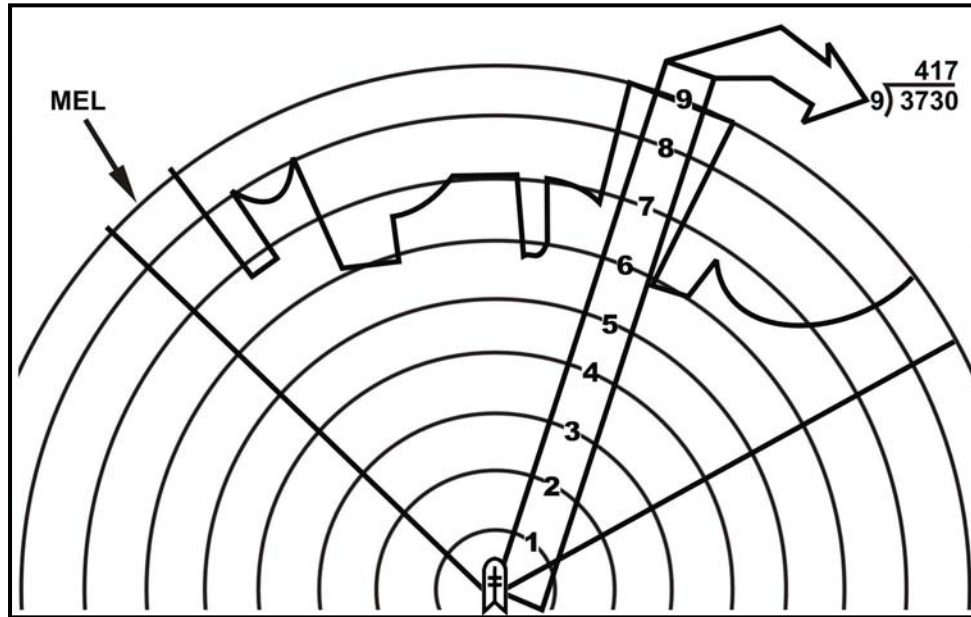
**NOTE:** Remember, the TOW's maximum effective range is 3,750 meters.

a. Using a map or leader-provided range data, determine the farthest point from the designated firing position to the MEL. (See paragraph D-5d for a discussion on how to determine MEL.)

b. Divide the number of circles on a range card (9) into the distance. Round the result to the nearest 10 meters. Enter this number in the data section. (See paragraph D-6). The following are examples:

(1) **Example 1.** If the distance of the farthest point from the designated firing position to the MEL is 3,750 meters, then 9 intervals into 3,750 meters = 416.666 meters rounded up to 420. Therefore, each circle equals 420 meters (Figure D-4, page D-4).

(2) **Example 2.** If the distance of the farthest point from the designated firing position to the MEL is 1,500 meters, then 9 intervals into 1,500 meters = 166.667 meters rounded up to 170 meters.



**Figure D-4. Determination of distance between circles.**

#### **D-5. SECTOR SKETCH SECTION DEVELOPMENT**

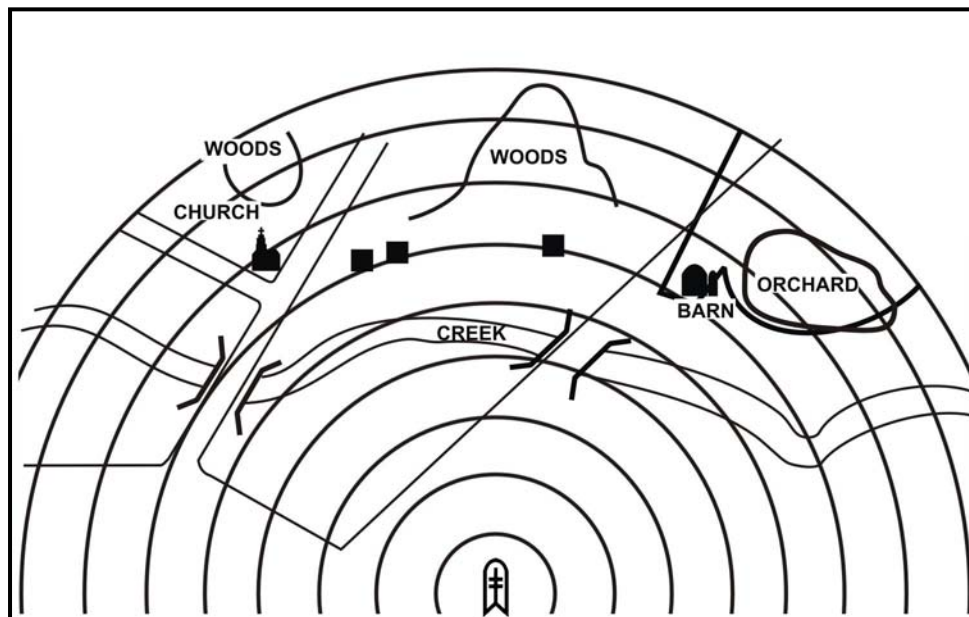
The sector sketch section is a graphic representation of a gunner's sector of fire (Figure D-5). The sector sketch of the terrain should be a good representation since it becomes vital during periods of limited visibility.

**NOTE:** A gunner may be assigned more than one sector of fire. A separate range card is prepared for each sector.

a. **Sketches.** The sketch should cover the entire assigned sector if possible. Make the sketch as large as possible, but do not exceed the limits of the largest circle. When depicting large natural objects (forests, hills, and so forth) or man-made objects (buildings, bridges, and so forth), draw the outline of the object and label it appropriately (Figure D-5). When sketching objects in the sector, locate them on or near the corresponding circle to denote range to the object.

**NOTE:** Do not try to depict contour lines on the sector sketch section.

b. **Gunner's Firing Position.** The gunner's firing position is designated by the black dot in the center of the smallest circle of the range card. Draw a symbol of the TOW over the black dot to designate that this range card is for a TOW.



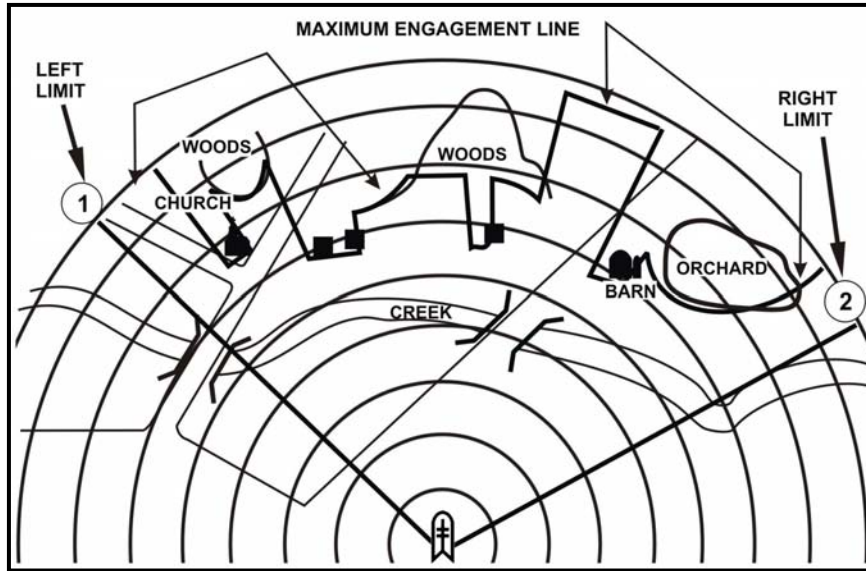
**Figure D-5. Sector sketch.**

c. **Left and Right Limits.** Left and right limits are imaginary lines from the gunner's firing position to a designated point on the ground (Figure D-6). Use terrain features when possible to designate left and right limits. Other recognizable objects, such as a building or other man-made structures, can be used. The area between the left and right limits depicts the gunner's sector of fire or area of responsibility. Lines are drawn from the designated firing position to the MEL in the area of the designated limits. Number the left limit as *No. 1*, number the right limit *No. 2*, and place a circle around each number. **Record the azimuth and distance of each limit in the data section.**

d. **Maximum Engagement Line.** The MEL designates the maximum effective range of a weapon (TOW) and the gunner's line-of-sight limitations due to the terrain in his given sector of fire (Figure D-6, page D-6).

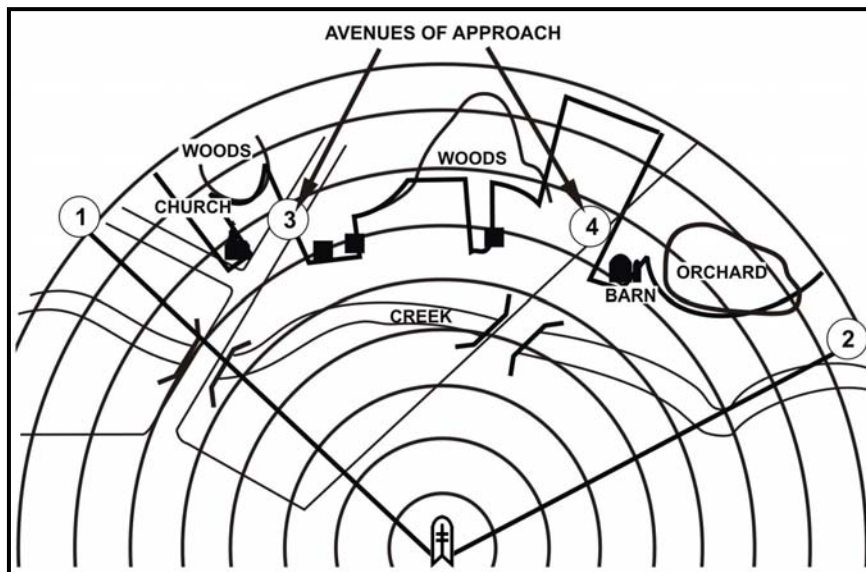
(1) If there are no limitations, draw the MEL along the last circle in the sector sketch section. The line should connect with the left and right limit labels.

(2) If there are limitations, starting at the left limit, draw the MEL in front of the limiting terrain features. The MEL should extend in front of and follow the limitations until it reaches the right limit.



**Figure D-6. Left and right limits of sector of fire and maximum engagement line.**

e. **Avenues of Approach.** Avenues of approach are areas where a target is most likely to appear or most likely to travel. This area can be a natural line of drift or a road. Tracked and wheeled vehicles may or may not use the same AA. Starting from the left and working to the right, number the areas where targets are likely to appear. Start with the number three since the numbers one and two have already been used to mark the left and right limits. Place a circle around each number. Continue until all identified AAs have an assigned number (Figure D-7). *Record the azimuth and distance to each AA in the data section.*



**Figure D-7. Avenues of approach.**

f. **Target Reference Points.** Prominent terrain features and or easily recognizable man-made objects (for example, road intersections, buildings, bridges, and so forth) are used as TRPs (Figure D-8). TRPs are used to locate targets and adjust direct or indirect fires. Normally, the sector has at least one TRP, but no more than three. Number each TRP and place a circle around each number starting with the next available number after AA numbers. In Figure D-8, there are two AAs and two TRPs—numbers 5 and 6 are assigned to the TRPs for this example. **Record the azimuth and distance to each TRP in the data section.**

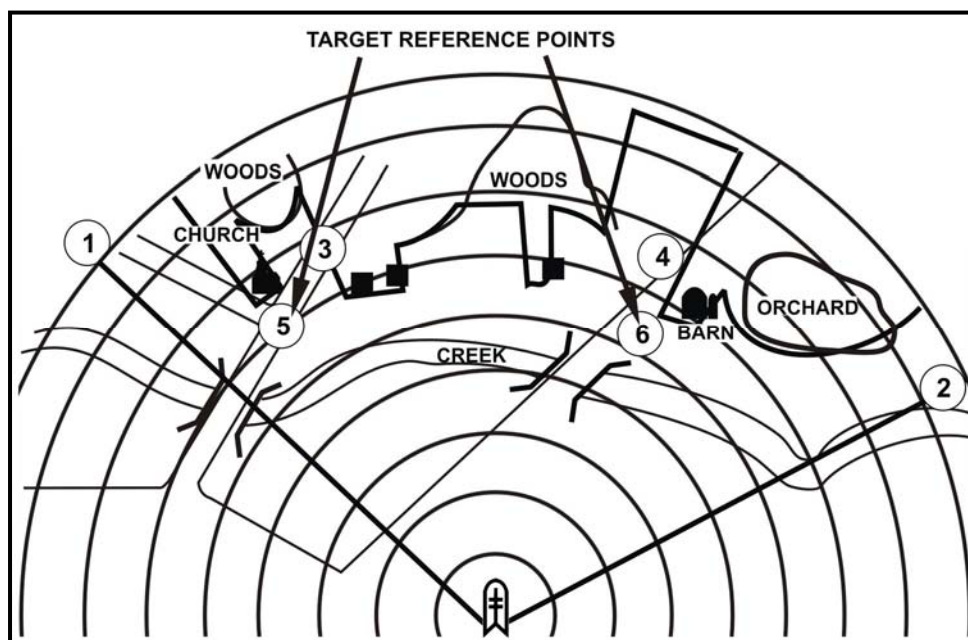


Figure D-8. Target reference points.

g. **Dead Space.** Dead space is an area inside a gunner's sector of fire and inside the range of his weapons system where he can neither observe nor place direct fire. Any area in which a gunner does not have line of sight is considered dead space (Figure D-9, page D-8). Buildings, trees, hills, or other terrain features can cause dead space. Shade these areas using diagonal lines to indicate significant dead space in the sector. These areas can then be identified as areas for indirect fire weapons.

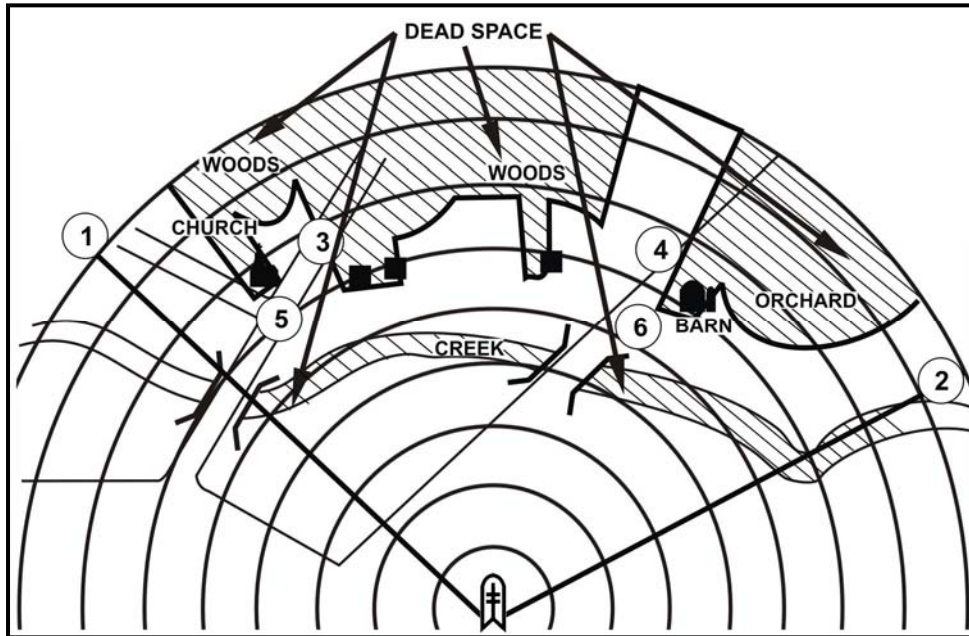


Figure D-9. Dead space.

h. **Gunner's Reference Point.** The gunner's reference point (GRP) serves as a point of reference when one unit is being replaced by another (Figure D-10). The gunner locates a nearby recognizable terrain feature (such as hilltop, road junction, and so forth) to the right, left, or rear of his firing position to use as his GRP. Label the GRP and draw an arrow between it and the firing position. The direction of the arrow determines which azimuth to use. *Record the azimuth and distance in the data section.*

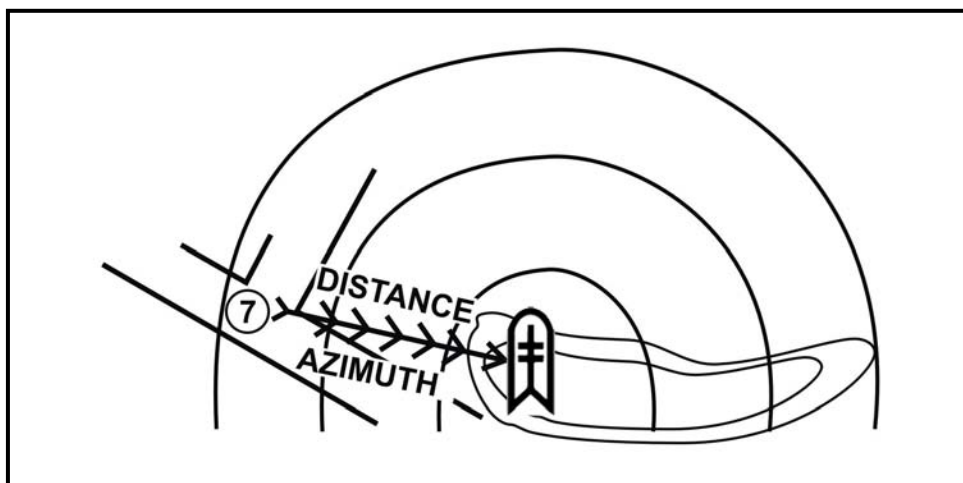


Figure D-10. Gunner's reference point and firing position.



**D-6. DATA SECTION**

Use the following procedures to fill in the DATA SECTION (Figure D-11). (Figure D-12, page D-10, shows an example of a completed range card for a TOW position.)

- a. **POSITION IDENTIFICATION.** Identify the position as either primary, alternate, or supplementary.
- b. **DATE.** Indicate only the day and month.
- c. **WEAPON.** Enter TOW.
- d. **NO. (number).** Use the numbers 1 and 2 to represent the left and right limits. Starting with the subsequent numbers, designate AAs and then TRPs as designated in the sector sketch section.
- e. **DIRECTION/DEFLECTION.** List only the DIRECTION, in degrees, for the appropriate item in the number (NO.) column. Line through the word DEFLECTION since it is not applicable.
- f. **ELEVATION.** Line through the word ELEVATION since it is not applicable. Draw a diagonal line through the boxes pertaining to ELEVATION.
- g. **RANGE.** Range is measured in meters from the designated firing position to the target or target engagement area. The most accurate way to measure range is the laser range finder.
- h. **AMMO.** Line through the word AMMO since it is not applicable. Draw a diagonal line through the columns pertaining to AMMO.
- i. **DESCRIPTION.** Write the name of the item listed in the corresponding NO. column (for example, road intersection, barn, church, and so forth). If the object is a TRP, list the TRP number; if left limit or right limit, enter LL or RL.
- j. **REMARKS.** Enter any information that is considered useful in helping understand the range card. Enter the GRP data here if the data section does not have sufficient room.

DATA SECTION					
POSITION IDENTIFICATION			DATE		
PRIMARY					
WEAPON  TOW		EACH CIRCLE EQUALS <u>220M</u>			
		METERS			
NO.	DIRECTION/ <del>DEFLECTION</del>	<del>ELEVATION</del>	RANGE	<del>AMMO</del>	DESCRIPTION
1	230°	/	1775M	/	LL
2	289°		1775M		RL
3	240°		1775M		ROAD - AA
4	246°		1775M		ROAD - AA
5	260°		1775M		CHURCH - AB1670
6	264°		1775M		BARN - AB1677
REMARKS: MAKE 2 COPIES (7) - GRP DIR 45° RANGE 150M DESCR-INTERSECTION					

DA FORM 5517-R, FEB 86

Figure D-11. TOW range card (DA Form 5517-R)—data section.

**STANDARD RANGE CARD**  
For use of this form see FM 7-8. The proponent agency is TRADOC.

SQD <u>1</u> PLT <u>3</u> CO <u>A</u>	May be used for all types of direct weapons.	MAGNETIC NORTH
---	--	-------------------

DATA SECTION				
POSITION IDENTIFICATION <b>PRIMARY</b>		DATE		
WEAPON <b>TOW</b>	EACH CIRCLE EQUALS <u>220</u> METERS			
NO.	DIRECTION/ DEFLECTION	ELEVATION	RANGE -AMMO-	DESCRIPTION
1	230°	/	1775 <sub>M</sub>	LL
2	289°	/	2000 <sub>M</sub>	RL
3	240°	/	1675 <sub>M</sub>	ROAD - AA
4	246°	/	1425 <sub>M</sub>	ROAD - AA
5	260°	/	1550 <sub>M</sub>	CHURCH - AB1670
6	264°	/	1350 <sub>M</sub>	BARN - AB1677

REMARKS:  
MAKE 2 COPIES (7) - GRP DIR 45° RANGE 150<sub>M</sub> DESCR-INTERSECTION

DA FORM 5517-R, FEB 86

Figure D-12. Example completed DA Form 5517-R, TOW range card.

### D-7. FIELD-EXPEDIENT RANGE CARD

Use a field-expedient range card when DA Form 5517-R is not available. Preparation of a field-expedient range card is basically the same as for a standard range card. The gunner can use almost anything to draw on as long as the data is recorded. As one example, a discarded MRE box works well (Figures D-13 and D-14).



Figure D-13. Terrain presentation.

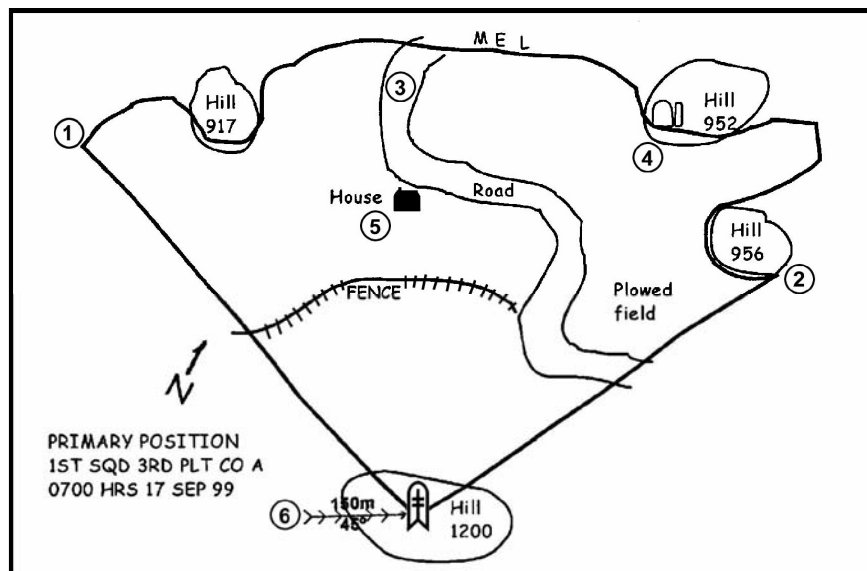


Figure D-14. Field-expedient range card showing the terrain.

**This page intentionally left blank.**

APPENDIX E  
**SYSTEM MESSAGES, WARNINGS,  
 AND MALFUNCTIONS**

*As with any piece of equipment, at times it does not operate. During normal operations the gunner may see system messages and warnings that require him to stand by or proceed with steps to correct the problem. Understanding the proper procedures to correct malfunctions is an essential gunner skill. Different indicators on the TAS display require the gunner to perform some type of action.*

**Section I. SYSTEM MESSAGES**

System messages and warning indicators appear during normal ITAS operation. These messages and warnings indicate that a system failure can occur if actions are not taken to correct the warning indicator. Some messages are displayed to the gunner through symbols on the TAS display as well as through text messages.

**E-1. BORESIGHT MESSAGES**

The following messages and warnings may appear on the ITAS during boresighting procedures.

a. **BORESIGHTING – DO NOT SLEW OR CAUSE VEHICLE MOTION.** This message occurs throughout the boresighting process. It is not an indication of a malfunction, but a warning not to slew the TU or cause vehicle motion during boresighting procedures. Any motion of the TAS will cause the readings taken by the FCS to vary and will slow the boresighting process.

**NOTE:** Only in an emergency should the gunner attempt to engage a target while this message is displayed.

b. **UNABLE TO BORESIGHT – MAINTENANCE REQUIRED.** This message appears upon completion of boresighting if there is a malfunction (the FCS cannot get stable readings). To correct, verify that the front window cover is over the lenses and repeat the boresighting process. If this message again, replace the TAS. If the message appears after replacing the TAS, replace the FCS.

c. **REDO BORESIGHT – EXCESSIVE MOTION.** This message appears when too much motion of the vehicle occurs while boresighting is in progress. To correct, press the MENU switch to select CANCEL. Ensure no one is moving around in the HMMWV (or touching the system when on the tripod). Close the HMMWV doors to minimize wind effects. Perform the boresighting procedures again.

d. **BORESIGHT COMPLETE.** This message is displayed for five seconds after completion of boresighting. After five seconds the boresighting menu disappears from the TAS display. No corrective action is necessary.

**E-2. BATTERY POWER SOURCE MESSAGES**

These messages concern the battery power source (BPS).

a. **CHARGE BPS NOW.** The vehicle battery voltage sensor in the BPS constantly monitors the BPS power output. When the sensor detects a level that corresponds to approximately 30 minutes of BPS operating time remaining, this message will appear. When this message appears, no more than 30 minutes of operating time in surveillance mode or 15 minutes of operation with the tracker can be expected, and only two or three missiles may be fired. To correct, recharge the BPS at the earliest opportunity.

b. **BPS INTERNAL.** A sensor in the BPS constantly compares the HMMWV voltage with the BPS voltage. When the sensor detects the HMMWV voltage is lower than the BPS voltage, the system will switch over to the BPS and the BPS INTERNAL message will appear.

**CAUTION**

The ITAS will power down if corrective action is not taken. This power down action is an over-discharge protection feature, which protects the batteries from deep discharge and subsequent damage.

(1) To correct, start the HMMWV to recharge its batteries, if the mission allows. The BPS INTERNAL message will disappear within two minutes after starting the HMMWV engine and the mission may be continued.

(2) If the HMMWV engine cannot be started because of the mission, turn the BPS function switch to BIT. If the BPS BIT FAIL message appears, repeat the power down, power up sequence.

(a) If the BPS passes the BIT, ensure the BPS INTERNAL message disappears from the TAS display.

(b) If the BPS passes the BIT, but the BPS INTERNAL message is displayed while the engine is running, the vehicle charging system requires maintenance.

(c) If the BPS still fails the BIT, turn the it in for maintenance.

c. **CHECK BPS OUTPUT.** This message appears when the BPS loses communication with the TAS. The messages BPS INTERNAL and CHARGE BPS NOW cannot be provided to alert the gunner to charge the BPS. To correct, the gunner checks the battery capacity periodically on the BPS Display by turning the function switch to BATT CAP, opening the BPS display door, and reading the BPS display (Figure E-1).

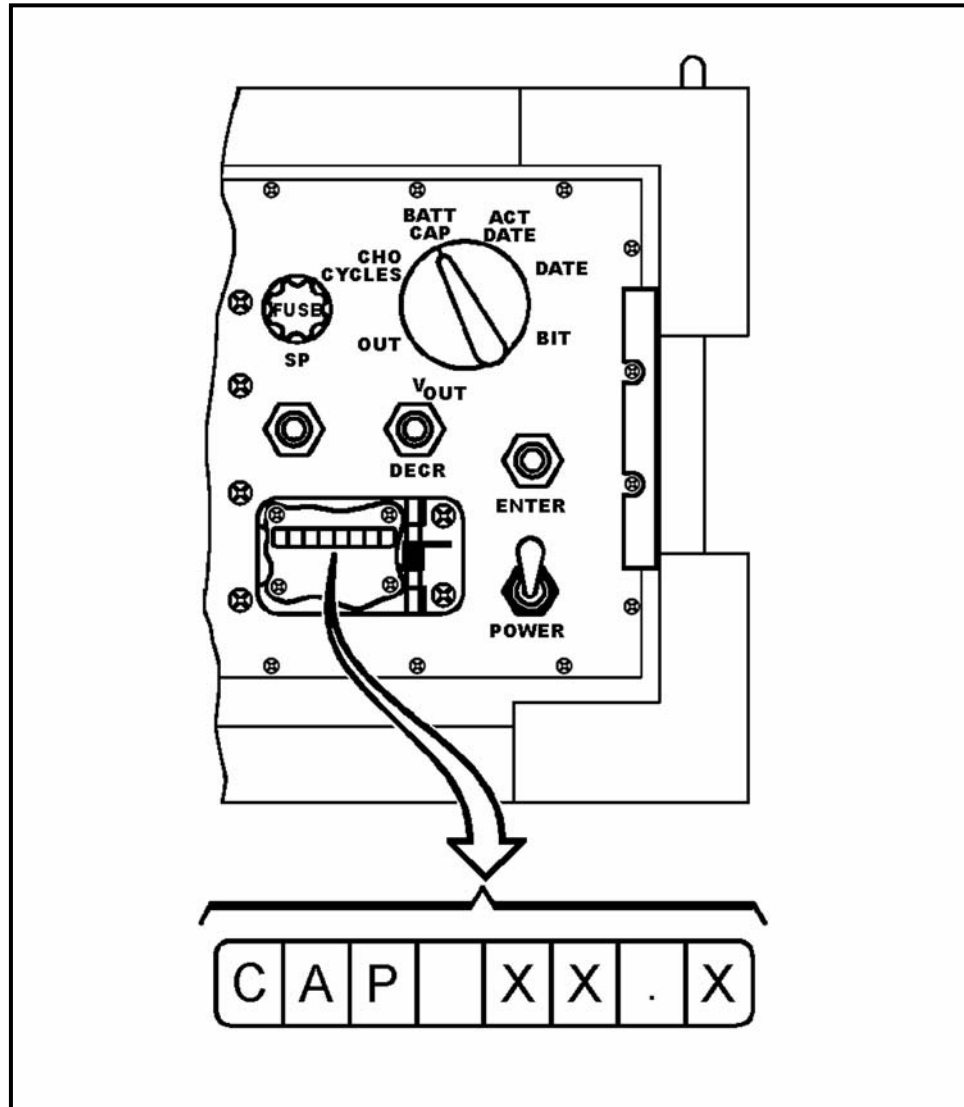
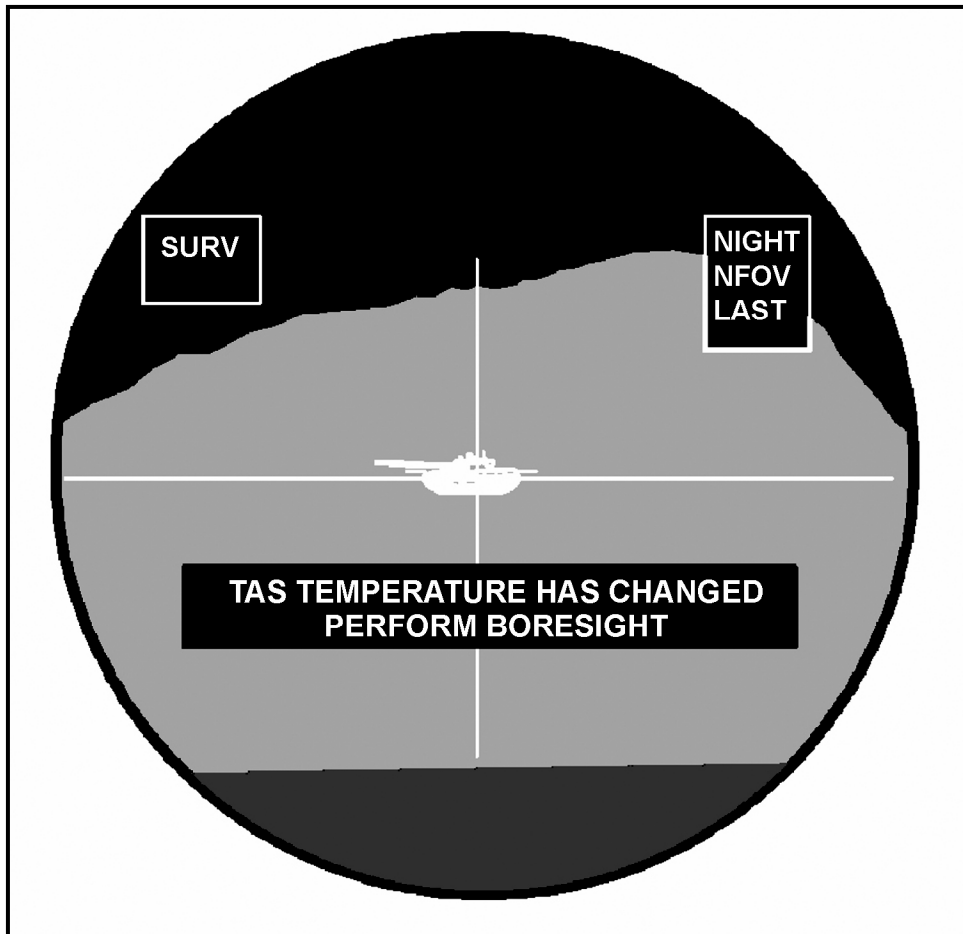


Figure E-1. BPS capacity.

### E-3. SYSTEM OPERATION MESSAGES

These system operation messages may appear at any time. They can be displayed in the TAS display in conjunction with other system or training messages due to the potential for mission-critical failure.

a. **TAS TEMPERATURE HAS CHANGED – PERFORM BORESIGHT.** As the temperature changes, optical assemblies within the TAS expand or contract and the daysight, NVS, LRF, and Xenon beacon tracker may no longer be aligned. The ITAS records the ambient temperature when the last boresight task was performed. When the temperatures vary  $\pm 18$  degrees Fahrenheit, the TAS displays the temperature change message (Figure E-2, page E-4). To correct, if the message appears during a target engagement, complete the engagement, then boresight the system again. If not in the process of engaging a target, boresight immediately.



**Figure E-2. Boresight message.**

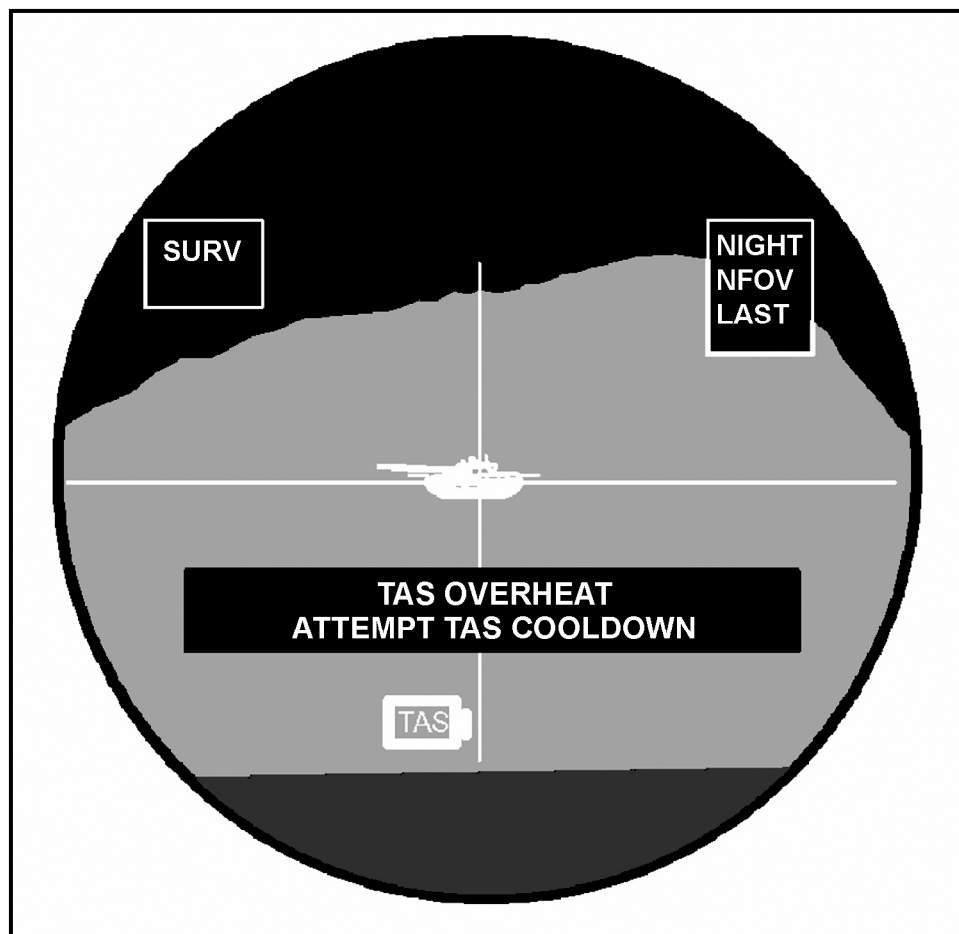
b. **FCS OVERHEAT – ATTEMPT FCS COOLDOWN.** This message appears when a temperature sensor in the FCS indicates the FCS is getting too hot. To correct, ensure there is adequate airflow around the FCS. Power down the TOW ITAS (TAS, FCS, and BPS) and try to find shade. Wait two hours and then power the system up again. If this message appears during a target engagement, complete the engagement and then turn the FCS off to prevent permanent damage. If this message appears during any of the training modes, discontinue training.

(1) If the system fails PBIT, discontinue the mission and turn the FCS in for maintenance as soon as possible (ASAP).

(2) If the system passes PBIT and this message reappears at any time thereafter, discontinue mission and turn FCS for maintenance ASAP.

c. **TAS OVERHEAT – ATTEMPT TAS COOLDOWN.** This message appears when a temperature sensor in the TAS says the TAS is getting too hot (Figure E-3). Follow the same corrective procedures as for the FCS.





**Figure E-3. TAS overhear message.**

d. **SELECT NVS BEFORE SELECTING TARGET TRACKER.** This message appears when the TRK GATE switch is pressed in the daysight mode. To correct, select the NVS mode before attempting to use the TRK GATE switch.

**NOTE:** The FCS tracker uses NVS video to form its contour map. When the gunner views NVS video, he can specify exactly what the target should be with the track gates.

e. **FOV CHANGE NOT ALLOWED DURING TARGET TRACKER USE.** This message will only appear after tracker lock-on. The gunner attempts to change the field of view by pressing the FOV switch after lock on. To correct, train the gunner not to change the FOV after the track gates are locked on a target.

**NOTE:** The contour mapping tracker in the FCS assumes that the target thermal features will remain mostly the same throughout its tracking mission. If the field of view is changed, the target thermal features will change and cause a break lock.

**E-4. BIT MESSAGES**

The gunner must not attempt to operate any switch while any of these messages are displayed.

a. **PBIT IN PROGRESS.** This message is displayed anytime the gunner places the TAS power switch in the ON position. No corrective action is necessary.

b. **PBIT COMPLETE.** This message is displayed when the PBIT has run to its completion. The gunner verifies that no malfunction indicators are on in the TAS display.

(1) If no indicators are ON in the TAS display, the gunner proceeds with the mission.

(2) If this message doesn't appear after 15 seconds or a malfunction indicator is on, follow the System Checkout Procedures.

c. **IBIT IN PROGRESS.** This message appears when the gunner selects BIT on the main menu and then selects IBIT from the BIT menu. No corrective action is necessary.

d. **IBIT COMPLETE.** This message is displayed when IBIT has run to its completion. The gunner verifies that no malfunction indicators are on.

(1) If no indicators are ON in the TAS display, proceed with mission.

(2) If this message does not appear after 45 to 60 seconds or a malfunction indicator is on, follow the system checkout procedures.

**E-5. TRAINING MESSAGES**

The following training messages are described herein.

a. **TRAINING PBIT FAIL.** This message appears if the training software cards in the FCS are not getting enough power after raising the arming lever. No menu will be displayed on the TAS display.

**NOTE:** This failure does not preclude the FCS from performing its tactical mission.

(1) Verify the failure if accessing the training mode for the first time.

(2) If the message appears during any subsequent raising of the arming lever while in any training mode, discontinue training. The FCS must be turned in for maintenance.

b. **SWITCH TO TNG MODE.** This message appears during use of the FTT. The gunner has raised the arming lever with a TMT loaded without selecting a training mode (TES). To correct, the gunner must call up the main menu, select TNG, then select TES from the training menu.

c. **ALL TEST IN PROGRESS.** This message is displayed during FTT operations to indicate the ALL test is in progress. Upon completion of the ALL test either the ALL TEST COMPLETE or the ALL TEST FAIL message will be displayed. No corrective action is necessary.

(1) **ALL TEST COMPLETE.** This message is displayed when the ALL test has run to its completion and did not detect any faults in the ET cards or TMT. The gunner should proceed with the mission.

(2) **ALL TEST FAIL.** This message is displayed when the ALL test has run to its completion and has detected a fault in the ET cards or TMT.

(a) To correct, the gunner should check and reseat the FTT W2 and W7 cables, then repeat the ALL test.

(b) If the ALL TEST FAIL message repeats, the gunner discontinues the FTT preoperational checks.

d. **TMT TEST IN PROGRESS.** This message is displayed during FTT operations to indicate the TMT test is in progress. Upon completion of the TMT test either the TMT TEST COMPLETE or the TMT TEST FAIL message will be displayed.

(1) **TMT TEST COMPLETE.** This message is displayed when the TMT test has run to its completion and did not detect any malfunction in the TMT. The gunner should proceed to the next operation.

(2) **TMT TEST FAIL.** This message is displayed when the TMT test has run to its completion and has detected a fault in the TMT.

(a) To correct, the gunner should check and reseat the FTT W2 and W7 cables, then repeat TMT test.

(b) If the TMT TEST FAIL message repeats, the gunner discontinues the FTT preoperational checks and replaces the TMT.

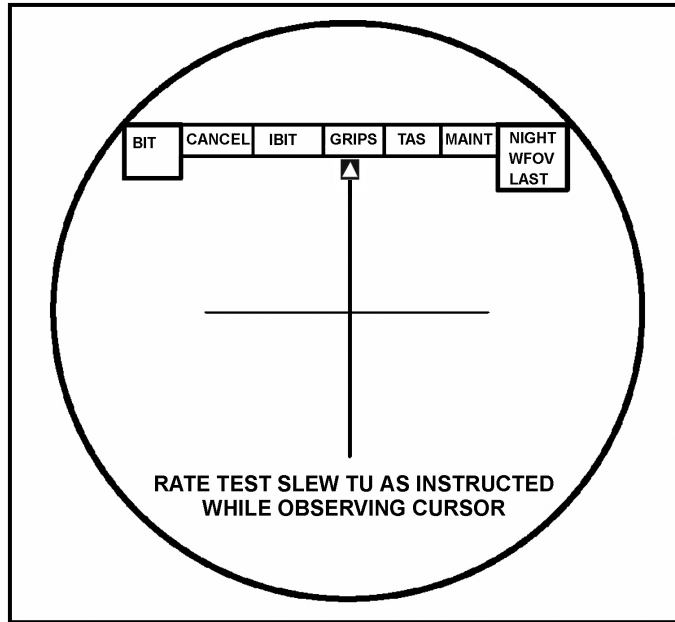
e. **TES MODE CONNECT TMT.** This message is displayed during FTT operations when TES MODE is selected from the training menu and the FTT software does not detect the presence of a TMT.

(1) To correct, the gunner should check and reseat the FTT W2 and W7 cables, then again select TES from the training menu. The gunner then exits the training menu, selects TNG menu again from the main menu and TES from the training menu.

(2) If the TES MODE, CONNECT TMT message repeats, discontinue FTT operations and replace the TMT.

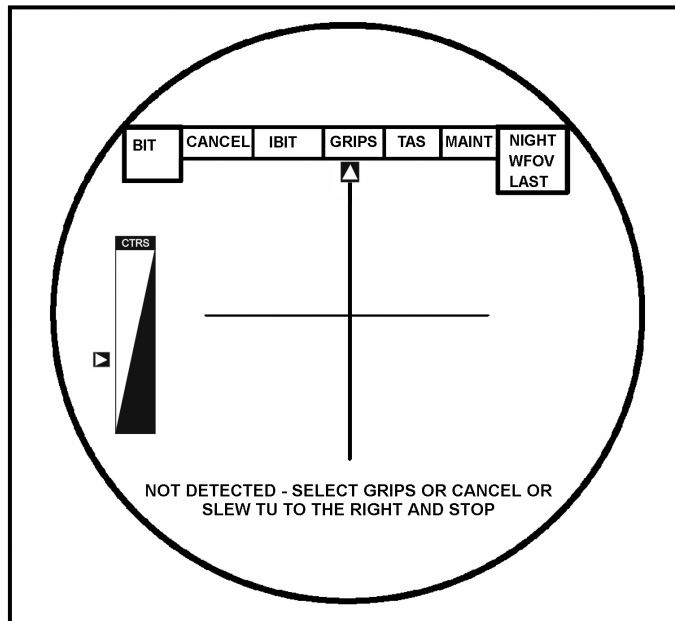
#### **E-6. GRIPS TEST MESSAGES**

GRIPS test messages are exclusive to system checkout procedures along with maintenance messages used by maintenance personnel to repair and maintain the equipment. The azimuth and elevation rate test is a gunner interactive test that makes a software check of the rate generators. The example in Figure E-4 (page E-8) is the first prompt for the azimuth and elevation rate test. (Refer to TM 9-1425-923-12 for more details on GRIPS test.)



**Figure E-4. GRIPS test prompt.**

- a. A message similar to the one in Figure E-5 will appear if the software does not detect the action required by each prompt. This message will display indefinitely until the gunner either selects GRIPS or CANCEL or performs the action requested.



**Figure E-5. Action not detected by software.**

- b. Selecting GRIPS tells the system that the action was performed but the software did not detect it and signals the software to continue the GRIPS test.
- c. Selecting CANCEL will abort the GRIPS test.

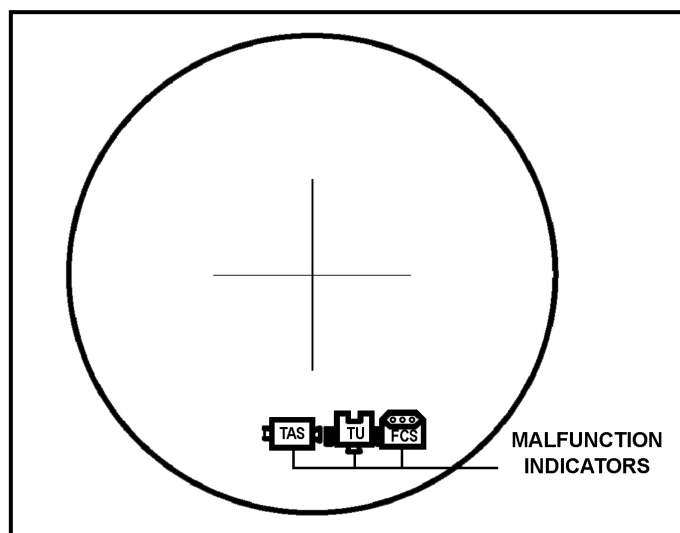
## Section II. MALFUNCTIONS

Messages and indicators in the TAS indicate malfunctions in the TOW ITAS system. System malfunctions are defined as a failure of a hardware component or a part of a hardware component to operate in its intended manner.

### E-7. SYSTEM BUILT-IN-TEST CAPABILITIES

Built-in tests run automatically and can be initiated by the gunner. These tests check the system and send the gunner messages indicating that the system is operating correctly. They identify components that are malfunctioning, and display a text message on the TAS display, or turn on an icon that the gunner must react to appropriately.

- a. **Power Up Built-In Test (PBIT).** When the TOW ITAS is first powered up, the PBIT procedure is automatically initiated and checks the TAS, FCS, and BPS to see if the power supplied to each is correct. The test lasts for approximately fifteen seconds and shows the results on the TAS display upon completion. A PBIT failure will be indicated when the appropriate indicator on the TAS display is illuminated (Figure E-6).



**Figure E-6. Malfunction indicators.**

- b. **Initiated BIT (IBIT).** After selecting BIT from the main menu, the gunner selects IBIT from the BIT menu. The IBIT test performs a detailed check of the TAS and FCS components lasting 45 to 60 seconds. The TAS cannot conduct the IBIT if a missile is loaded and armed. The gunner must lower the arming lever to conduct IBIT with a missile loaded.
- c. **Continuous Built-In Test (CBIT).** While the TOW ITAS is in operation, the CBIT monitors the functions of the TOW ITAS components. All failures detected by the CBIT are indicated by lighting the appropriate indicator on the TAS display.

**E-8. TAS MALFUNCTIONS AND CORRECTIVE ACTIONS**

This paragraph describes the causes of various problems with the TAS and ways to correct them.

a. **TAS Indicator on in the TAS Display.** If the TAS indicator is ON in the TAS display, CBIT has detected a TAS fault during system operation. It may also be a false indicator.

(1) Based on the tactical situation and the squad leader's guidance, the gunner complies with the corrective actions described to verify the problem. If it is a false indicator, one of the corrective actions will correct the problem. If at the end of all corrective actions the indicator remains ON, then the system is deadlined.

(2) Corrective actions for this problem are as follows:

(a) Place the power switch in the STANDBY position, then back to ON. If after completion of PBIT the indicator is OFF, continue with the mission. If after completion of PBIT the indicator is still ON, proceed to the next step.

(b) Perform the IBIT.

- If the TAS indicator remains ON at the completion of IBIT, discontinue the mission. Notify the squad leader that you have a TAS failure.
- If TAS indicator is **not** ON at the completion of IBIT, proceed to boresighting.

(c) Perform boresighting procedures.

- If the TAS indicator comes back on at the completion of boresighting, or if the system fails boresighting for any reason, notify the squad leader that you have a TAS failure.
- If the TAS indicator is **not** ON at the completion of boresighting, proceed to GRIPS test.

(d) Perform the GRIPS test.

- If the TAS indicator comes back on at the completion of the GRIPS test or if the system fails the GRIPS test for any reason, notify the squad leader that you have a TAS failure.
- If the TAS indicator is **not** ON at the completion of the grips test, continue the mission.

b. **No TAS Display.** If there is no TAS display, the TAS is not getting power. Check the TAS installation on the TU and the FCS and BPS cable connections. If there is still no display, notify the squad leader.

c. **Degraded TAS Display.** On a degraded TAS display, the video may be too light, too dark, or distorted, or the symbols may be wrong.

(1) If the NVS video is too light, too dark, or distorted the NVS is not optimized. Take the following corrective actions:

- Adjust the brightness and contrast.
- Use the daysight if visibility conditions permit.
- Replace the TAS at the earliest opportunity.

**NOTE:** In an emergency, during daylight hours, the target can still be engaged if the daysight crosshairs are present.

(2) If the NVS video is OK but the symbols are not right, the symbology circuits are not working. Take the following corrective actions:

- Use the daysight if visibility conditions permit.
- Replace the TAS at the earliest opportunity.

d. **NVS NOT COOL Indicator Stays On and the TAS Indicator is Lit.** If the NVS NOT COOL indicator takes longer than 15 minutes to go out and the TAS indicator is lit, the SADA II cooler is not cooling the NVS detectors down to their operating temperature. Take the following corrective actions:

- Check to see if the sun is shining directly on the SADA II cooler or if the airflow around the SADA II cooler is blocked. Shade the SADA II cooler and remove any object blocking the airflow around it.
- If the NVS has not cooled by the end of 15 minutes, replace the TAS.

**NOTE:** If the NVS cools but it takes longer than 15 minutes, the system will work with the TAS indicator on, but the TAS will soon reach the point where it will never cool down and it should be replaced at the earliest opportunity.

e. **TOW ITAS Powers Down Due to Low BPS Power.** Failure to charge the BPS within 30 minutes after receiving the message CHARGE BPS NOW or defective internal batteries will cause the ITAS to power down. Take the following corrective actions:

(1) Power down the ITAS, start the vehicle's engine, and repeat the power-up procedures.

(2) Turn the BPS function switch to BIT.

- If the BIT FAIL message is displayed, turn the BPS in for maintenance.
- If the BIT PASS message is displayed, turn on the FCS and TAS.

(3) After TAS power-up—

- Check to ensure the BPS INTERNAL message is not displayed. If it is, the HMMWV's charging system needs maintenance.
- Read the BPS capacity, then wait 10 minutes to ensure BPS capacity is increasing.
- Read BPS capacity again in 20 minutes to ensure capacity is still increasing. If it is not, the BPS has a defective internal battery and needs to be replaced.

f. **TAS OVERHEAT – ATTEMPT TAS COOLDOWN.** If this message appears, the TAS is getting too hot. For corrective actions, refer to paragraph E-3.

g. **TAS TEMPERATURE HAS CHANGED – PERFORM BORESIGHT.** If this message appears, a temperature change of more than 18 degrees Fahrenheit (10 degrees centigrade) has occurred. For corrective actions, refer to paragraph E-3.

h. **UNABLE TO BORESIGHT – MAINTENANCE REQUIRED.** If this message appears, the FCS cannot obtain a stable reading. For corrective actions, refer to paragraph E-3.

## **E-9. FCS MALFUNCTIONS AND CORRECTIVE ACTIONS**

This paragraph describes the causes of various problems with the FCS and ways to correct them.

a. **FCS Indicator on in the TAS Display.** If the FCS indicator is on in the TAS display, the CBIT has detected an FCS fault during system operation. It may also be a false indicator.

(1) Based on the tactical situation and the squad leader's guidance, the gunner complies with the corrective actions described to verify the problem. If it is a false indicator, one of the corrective actions will correct the problem. If at the end of all corrective actions the indicator remains ON, then the system is deadlined.

(2) Corrective actions for this problem are as follows:

(a) Place the power switch in the STANDBY position, then back to ON. If after completion of PBIT the indicator is OFF, continue with the mission. If after completion of PBIT the indicator is still ON, proceed to the next step.

(b) Perform the IBIT.

- If the FCS indicator remains ON at the completion of IBIT, discontinue the mission. Notify the squad leader that you have an FCS failure.
- If the FCS indicator is **not** ON at the completion of IBIT, proceed to boresighting.

(c) Perform boresighting procedures.

- If the FCS indicator comes back on at the completion of boresighting, or if the system fails boresighting for any reason, notify the squad leader that you have an FCS failure.
- If the FCS indicator is **not** ON at the completion of boresighting, proceed to the GRIPS test.

(d) Perform the GRIPS test.

- If the FCS indicator comes back on at the completion of the GRIPS test or if the system fails the GRIPS test for any reason, notify the squad leader that you have an FCS failure.
- If the FCS indicator is **not** ON at the completion of the GRIPS test, continue the mission.

b. **No TAS Display, FCS BIT Lamp Comes On and Stays On.** If there is no TAS display or the FCS BIT lamp comes on and stays on, a fault has been detected in the FCS. To correct, replace the FCS.

c. **FCS OVERHEAT – ATTEMPT FCS COOLDOWN.** If this message appears, there is inadequate air circulation or a heat sensor has malfunctioned. For corrective actions, refer to paragraph E-3.

## **E-10. BPS MALFUNCTIONS AND CORRECTIVE ACTIONS**

This paragraph describes the causes of various problems with the BPS and ways to correct them.

a. **CHARGE BPS NOW.** If this message appears, the BPS has 30 minutes of power remaining. For corrective actions, refer to paragraph E-3.

b. **BPS Will Not Power Up.** If the BPS will not power up, possible causes could be a blown fuse, a faulty internal battery, or a faulty circuit card. To correct, remove and replace fuse F1 and attempt to power up the system again. Discontinue operations and replace the BPS if it still does not power up.



c. **Results of BIT Not Passed to Gunner.** If results of BIT cannot be passed to the gunner, no power is being provided to the TAS, or the system has failed BPS PBIT or system PBIT. Take the following corrective actions:

- (1) Power down the TOW ITAS. Power up following the correct procedure.
- (2) Check all cable connections.
  - Ensure the TAS mount coupling clamp is closed and TAS mount locking collar is engaged.
  - Ensure the TU coil cable is connected to the FCS J2 connector.
  - Ensure the interface cable is connected to the FCS J1 and BPS J2 connectors.
- (3) Attempt to power up again. If there is still no power, report to the squad leader.

#### E-11. TRAVERSING UNIT MALFUNCTIONS AND CORRECTIVE ACTIONS

This paragraph describes the causes of various problems with the TU and ways to correct them.

a. **TU Indicator on in the TAS Display.** If the TU indicator is on in the TAS display, the CBIT has detected a TU fault during system operation. It may also be a false indicator.

(1) Based on the tactical situation and the squad leader's guidance, the gunner complies with the corrective actions described to verify the problem. If it is a false indicator, one of the corrective actions will correct the problem. If at the end of all corrective actions the indicator remains ON, then the system is deadlined.

(2) Corrective actions for this problem are as follows:

(a) Place the power switch in the STANDBY position, then back to ON. If after completion of PBIT the indicator is OFF, continue with the mission. If after completion of PBIT the indicator is still ON, proceed to the next step.

(b) Perform the IBIT.

- If the TU indicator remains ON at the completion of IBIT, discontinue the mission. Notify the squad leader that you have a TU failure.
- If the TU indicator is **not** ON at the completion of IBIT, proceed to boresighting.

(c) Perform boresighting procedures.

- If the TU indicator comes back on at the completion of boresighting, or if the system fails boresighting for any reason, notify the squad leader that you have a TU failure.
- If the TU indicator is **not** ON at the completion of boresighting, proceed to the GRIPS test.

(d) Perform the GRIPS test.

- If the TU indicator comes back on at the completion of the GRIPS test or if the system fails the GRIPS test for any reason, notify the squad leader that you have a TU failure.
- If the TU indicator is **not** ON at the completion of the GRIPS test, continue the mission.

b. **Handgrip Switches Do Not Respond.** If the handgrip switches do not respond when activated during LRF use, BCF adjustments, or track gate adjustments, the TAS software has not received the switch activation. Take the following corrective actions:

- (1) Lower the arming lever if it is raised.

(2) Turn the TAS power switch to STANDBY momentarily and then back to ON to initiate the PBIT.

(3) If PBIT passes, perform the GRIPS test. If the GRIPS test passes, continue the mission. If the GRIPS test fails, notify the squad leader and refer to Table E-1 for guidance.

(4) If PBIT fails, turn the system in.

HANDGRIP SWITCH	DETECTED	OPERATOR ACTION (IF NOT DETECTED)	ORGANIZATIONAL GUIDANCE (IF NOT DETECTED)
FLTR	YES / NO	Proceed to operator checks; notify squad leader.	N/A
FOV	YES / NO	Proceed to operator checks; notify squad leader.	Targets can still be engaged in the FOV available. Selection between wide and narrow FOVs is not available.
SGT SEL	YES / NO	Proceed to operator checks; notify squad leader.	Targets can still be engaged using the available sight. Selection between the daysight and NVS is not available.
BCF BCF Up BCF Down	YES / NO	Proceed to operator checks; notify squad leader.	Targets can still be engaged with the NVS if the display is satisfactory, or can be engaged with the daysight. BCF cannot be adjusted and zoom capability is not available.
	YES / NO		
	YES / NO		
LRF	YES / NO	Proceed to operator checks; notify squad leader.	Targets can still be engaged if range to target can be determined using passive ranging capabilities. Conformation of active laser ranging is not available.
FIRST/ LAST	YES / NO	Proceed to operator checks; notify squad leader.	Targets can still be engaged if range to target can be determined using passive ranging capabilities. Conformation of active laser ranging is not available.
TRK GATE	YES / NO	Proceed to operator checks; notify squad leader.	Targets can still be manually engaged. Aided target tracking capabilities are not available.
GATE ADJ Right GATE ADJ Left GATE ADJ Up GATE ADJ Down	YES / NO	Proceed to operator checks; notify squad leader.	Targets can still be manually engaged. Aided target tracking and passive ranging capabilities are not available.
	YES / NO		
	YES / NO		
	YES / NO		
L and R Handgrip Release	YES / NO	Proceed to operator checks; notify squad leader.	Targets can still be engaged if handgrips can be adjusted satisfactorily for the operator to perform tracking.
Fire Trigger	YES / NO	Discontinue system checkout.	Replace traversing unit. Missile launch capability not available.

**Table E-1. Traversing unit handgrip switch test guidance.**

## E-12. MISSILE FAULT

A missile fault is a missile malfunction that occurs after the fire trigger is pressed. The missile faults are hangfire and misfire.

a. **Hangfire Procedures.** A hangfire is an unexpected delay in the functioning of a series of ammunition components. It may occur anywhere in the series of events, from pulling the firing trigger to launch motor ignition. After the trigger is pulled, the distinctive impulse of the squibs firing to activate the missile batteries and gyro and the gyro spin noise can be heard.

- (1) If the missile fails to fire, alert the crew by announcing HANGFIRE.
- (2) Continue to track the target for one minute.
- (3) Lower the arming lever.
- (4) Lock the ITAS in the 8-degree down position.
- (5) Open the bridge clamp and remove the missile from the launch tube.
- (6) Keeping the missile pointed toward the engagement area, move the missile a safe distance away from the firing position (minimum 100 meters).
- (7) Hangfire procedures for training only are:
  - (a) Wait 30 minutes before attempting to remove the missile.
  - (b) On a firing range keep the missile pointed downrange at all times. Move the missile a safe distance away (minimum 100 meters) and place it on the ground, preferably in a dud pit. Notify EOD personnel.

b. **Misfire Procedures.** A misfire (complete failure to fire) occurs if the launch motor fails to ignite after the fire trigger is pressed. This type of failure may be caused by a faulty firing circuit, a failure of electrical power, poor electrical connections, short circuits, or by faulty components in the ignition or propellant systems. When the missile fails to launch and the prefire functions are not heard, the condition is misfire.

**NOTE:** The elevation brake makes a sound during missile launch. Do not confuse this sound with a hangfire indication.

- (1) If the missile fails to fire, pull the fire trigger again and continue to track the target for one minute.
- (2) Alert the crew by announcing MISFIRE.
- (3) Continue to track the target for one minute.
- (4) Lower the arming lever.
- (5) Lock the ITAS in the 8-degree down position.
- (6) Check the FCS to ensure the coil cable connector is properly attached to the J1 connector on the FCS. Turn the coil cable connector locknut clockwise until tight to make sure it is locked in place.
- (7) Check the bridge clamp to verify it is seated.
- (8) Check the backblast area to ensure no personnel are in the danger zone.
- (9) Raise the arming lever. Ensure the umbilical connector makes contact with the missile electrical connector.
- (10) Pull the fire trigger again.
- (11) If the missile still fails to launch, announce MISFIRE and continue to track the target for one minute.
- (12) Lower the arming lever.

- (13) Lock the ITAS in the 8-degree down position.
- (14) Open the bridge clamp.
- (15) Remove the missile from the launch tube.
- (16) Keeping the missile pointed toward the engagement area, move the missile a safe distance away from the firing position (minimum 100 meters).
- (17) Misfire procedures for training only are:
  - (a) Wait 30 minutes before attempting to remove the missile.
  - (b) On a firing range, keep the missile pointed downrange at all times. Move the missile a safe distance away (minimum 100 meters) and place it on the ground, preferably in a dud pit. Notify EOD personnel.

### **E-13. DESTRUCTION PROCEDURES**

ITAS crewmembers must recognize and overcome performance problems and limitations to survive in battle. Each unit develops and maintains an SOP for the proper destruction of ammunition, dunnage, and weapon systems.

## GLOSSARY

AA	avenue of approach
AAR	after-action review
AC	alternating current
ADA	air defense artillery
APC	armored personnel carrier
ASAP	as soon as possible
ASP	ammunition supply point
ATGM	antitank guided missile
ATT	aided target tracking
ATWESS	antitank weapon effect signature simulator
BCF	brightness, contrast, focus
BDA	battle damage assessment
BDU	battle dress uniform
BIT	built-in test
BPS	battery power source
BST	basic skills trainer
CARC	chemical agent resistant coating
CBIT	continuous built-in test
CGP	commander's ground pointer
CMF	career management field
DA	Department of the Army
DC	direct current
DNFOV	daysight narrow field of view
DWFOV	daysight wide field of view
EFP	explosively formed projectile
EOD	explosive ordnance disposal
ET	embedded training
FCS	fire control system
FM	field manual
FOSD	fly over/shoot down
FOV	field of view
FTT	field tactical trainer
GRP	gunner's reference point
GST	Gunner's Skill Test
HIC	HMMWV interface cable
HMMWV	high mobility, multiwheeled vehicle

I2R	imaging infrared
IBIT	initiated built-in test
IR	infrared
ITAS	Improved Target Acquisition System
LOS	line of sight
LRF	laser range finder
MBT	main battle tank
MEL	maximum engagement line
METL	mission-essential task list
METT-TC	mission, enemy, terrain, time, troops, civil considerations
MGS	missile guidance set
MILES	Multiple Integrated Laser Engagement System
MRE	meals ready-to-eat
MSR	missile simulation round
MWO	modification work order
NBC	nuclear, biological, and chemical
NCO	noncommissioned officer
NCOES	Noncommissioned Officer Education System
NFOV	narrow field of view
NVG	night vision goggles
NVS	night vision sight
OES	Officer Education System
OSUT	one-station unit training
PBIT	power up built-in test
PMCS	preventive maintenance checks and services
POI	program of instruction
ROE	rules of engagement
SADA	standard advanced dewar assembly
SAO	sensor acquired object
SFCS	simulated fire control system
SOP	standing operating procedures
STAS	simulated tactical acquisition system
STX	situational training exercise

TES	target engagement simulation
TEWT	tactical exercise without troops
TFTT	TOW field tactical trainer
TM	technical manual
TMDE	test, measurement, and diagnostic equipment
TMT	training missile tube
TOW	tube-launched, optically tracked, wire-guided
TRP	target reference point
TU	traversing unit
U.S.	United States
V	volt
WFOV	wide field of view

**This page intentionally left blank.**



## REFERENCES

### Readings Recommended

*These readings contain relevant supplemental information.*

AR 385-63	Range Safety. 19 May 2003.
ARTEP 7-91-Drill	Drills for the Antiarmor (TOW) Platoon, Section, and Squad. 26 July 2002.
ARTEP 7-91-MTP	Mission Training Plan for Antiarmor Company/Platoon/Section. 12 October 1989.
DA Form 2028	Recommended Changes to Publications and Blank Forms
DA Form 2404	Equipment Inspection and Maintenance Worksheet
DA Form 5517-R	Standard Range Cards
DA Form 7540-R	Gunner's Skill Test (ITAS)
DA Form 7541-R	ITAS Gunnery Exercise 5 and 6: Baseline FTT Gunnery
DA Form 7542-R	ITAS Gunnery Exercise 7: Squad Gunnery Practice FTT
DA Form 7543-R	ITAS Gunnery Exercise 8: Squad Gunnery Qualification FTT
DA Form 7544-R	ITAS Gunnery Exercise 9: Section Gunnery Practice FTT
DA Form 7545-R	ITAS Gunnery Exercise 10: Section Gunnery Qualification FTT
DA Form 7546-R	ITAS Gunnery Exercise 11: Platoon Gunnery Practice FTT
DA Form 7547-R	ITAS Gunnery Exercise 12: Platoon Gunnery Qualification FTT
DA Pam 350-38	Standards in Weapons Training.
FM 3-06.11	Combined Arms Operations in Urban Terrain. 28 February 2002.
FM 3-21.9	SBCT Infantry Rifle Platoon and Squad. 2 December 2002.
FM 3-21.71	Mechanized Infantry Platoon and Squad (Bradley). 20 August 2002.

- FM 3-21.91 Tactical Employment of Antiarmor Platoons and Companies. 26 November 2002.
- FM 3-22.34 TOW Weapon System. 28 November 2003.
- FM 7-1 Battle Focused Training. 15 September 2003.
- FM 7-7 The Mechanized Infantry Platoon and Squad (APC). 15 March 1985.
- FM 7-8 Infantry Rifle Platoon and Squad. 22 April 1992.
- FM 7-10 The Infantry Rifle Company. 14 December 1990.
- FM 7-100 Opposing Force Doctrinal Framework and Strategy. 01 May 2003.
- FM 22-100 Army Leadership. 31 August 1999.
- TM 9-1410-470-34 Direct Support and General Support Maintenance Manual for Surveillance of Guided Missile Surface Attack BGM-71 Series and Guided Missile Practice BTM-71 Series (TOW Heavy Antitank/Assault Weapon System). 1 October 2003.
- TM 9-1425-923-12 ITAS Operator and Organization Maintenance Manual. March 2004 (Draft).
- TM 9-6920-721-10 Field Tactical Trainer ITAS, M41. March 2004 (Draft).

**Internet Web Sites**

U.S. Army Publishing Directorate (USAPD): <http://www.usapa.army.mil>

Army Doctrine and Training Digital Library: <http://www.adtdl.army.mil>

## INDEX

- aided target tracker, 1-19, 4-15, 5-2
- backlighting, C-25 (illus)
- basic skills trainer, B-1
  - assembly and operations, B-2
  - components, B-2
  - features, B-2
- built-in-test capabilities, E-9
  - continuous, E-9
  - initiated, E-9
  - power up, E-9 (illus)
- caution zone, A-1, A-2 (illus)
- clearance, 4-8 (illus)
- components, 1-2
  - battery power source, 1-7 (illus)
  - encased missile, 1-15, 1-16 (illus)
  - fire control system, 1-5, 1-6 (illus)
  - launch tube, 1-13 (illus)
  - lithium-ion power source, 1-8 (illus)
  - target acquisition system, 1-2, 1-3 (illus), 1-4 (illus)
  - traversing unit, 1-9 through 1-13 (illus)
  - tripod, 1-13 through 1-15 (illus)
- DA Form 5517-R, Standard Range Card, D-1 through D-10
  - example completed, D-10 (illus)
  - sections, D-1 (illus)
    - data, D-9 (illus)
    - marginal information, D-2, D-3 (illus)
    - sector sketch, D-4 through D-8
      - dead space, D-7, D-8 (illus)
      - gunner's firing position, D-4
      - gunner's reference point, D-8 (illus)
      - left and right limits, D-5, D-6 (illus)
      - maximum engagement line, D-5, D-6 (illus)
      - target reference points, D-7 (illus)
- DA Form 7540-R, Gunner's Skill Test (ITAS), 6-6, 6-7 (illus)
- DA Form 7541-R, ITAS Gunnery Exercises 5 and 6: Baseline FTT Gunnery, 6-8 (illus)
- DA Form 7542-R, ITAS Gunnery Exercise 7: Squad Gunnery Practice FTT, 6-8, 6-9 (illus)
- DA Form 7543-R, ITAS Gunnery Exercise 8: Squad Gunnery Qualification FTT, 6-8, 6-10 (illus)
- DA Form 7544-R, ITAS Gunnery Exercise 9: Section Gunnery Practice FTT, 6-11 (illus)
- DA Form 7545-R, ITAS Gunnery Exercise 10: Section Gunnery Qualification FTT, 6-11, 6-12 (illus)
- DA Form 7546-R, ITAS Gunnery Exercise 11: Platoon Gunnery Practice FTT, 6-13 (illus)
- DA Form 7547-R, ITAS Gunnery Exercise 12: Platoon Gunnery Qualification FTT, 6-13, 6-14 (illus)
- danger zone, A-1, A-2 (illus)
- daysight, 1-18, 1-19 (illus)
- electromagnetic spectrum, C-1 (illus)
- employment, 5-1 through 5-7
  - antiarmor ambush, 5-4 (illus)
  - capabilities, 5-2
  - defensive operations, 5-4
    - firing positions, 5-6 (illus)
    - ITAS placement, 5-6
    - personnel duties, 5-5 (table)
  - fundamentals, 5-1 through 5-2
    - aided target tracker versus manual engagement, 5-2
    - combined arms team, 5-2
    - cover and concealment, 5-2
    - depth, 5-2
    - flank engagements, 5-1
    - mutual support, 5-1
    - security, 5-1
    - stand-off range, 5-1
- mobility, 5-2
- offensive operations, 5-3 (illus)

- stability and support operations, 5-7
- urban operations, 5-7
- engagement considerations, 5-7
  - breaching structural walls, 5-7
  - crossover, 5-7
  - distance, 5-7
- exposure time, 4-12
  - binocular, 4-12 (illus)
  - daysight method, 4-12
  - nightsight method, 4-12
- fields of view, 1-17 through 1-18
  - daysight, 1-18, 1-19 (illus)
  - night vision sight, 1-17, 1-18 (illus)
- field tactical trainer, B-3
  - assembly and operation, B-3
  - components, B-3, B-4 (illus)
  - features, B-3
- fighting positions, 5-8 through 5-10
  - camouflage, 5-10
  - dismounted, 5-8 (illus)
  - mounted, 5-9, 5-10 (illus)
- fire commands, 4-12 through 4-15
  - additional, 4-15
  - correcting errors in, 4-15
  - elements of, 4-12
    - alert, 4-13
    - type of missile, 4-13
    - target description, 4-13, 4-14 (table)
    - target direction, 4-14
      - target reference point, 4-14
    - range, 4-14
    - execution, 4-14
  - example of 4-13, (illus)
  - repeating, 4-15
- firing, 4-1 through 4-8
  - from bunkers, and buildings, 4-8
  - in windy conditions, 4-8
  - over electrical lines, 4-7
  - range over water, 4-1 through 4-7
    - extended, 4-4 through 4-7 (tables)
    - limited, 4-3 (illus)
    - maximum, 4-2 (illus)
  - through smoke and area fires, 4-8
- firing positions, 3-6, 3-28
  - dismounted, 3-28
    - actions, 3-28
  - mounted, 3-6
- Gunner's Skill Test (ITAS), DA Form 7540-R, 6-6, 6-7 (illus)
- gunnery training, 6-6
  - individual, 6-6
    - DA Form 7540-R, Gunner's Skill Test (ITAS), 6-6, 6-7 (illus)
  - platoon, 6-13
    - DA Form 7546-R, ITAS Gunnery Exercise 11: Platoon Gunnery Practice FTT, 6-13 (illus)
    - DA Form 7547-R, ITAS Gunnery Exercise 12: Platoon Gunnery Qualification FTT, 6-13, 6-14 (illus)
  - section, 6-11
    - DA Form 7544-R, ITAS Gunnery Exercise 9: Section Gunnery Practice FTT, 6-11 (illus)
    - DA Form 7545-R, ITAS Gunnery Exercise 10: Section Gunnery Qualification FTT, 6-11, 6-12 (illus)
  - squad, 6-8
    - DA Form 7541-R, ITAS Gunnery Exercises 5 and 6: Baseline FTT Gunnery, 6-8 (illus)
    - DA Form 7542-R, ITAS Gunnery Exercise 7: Squad Gunnery Practice FTT, 6-8, 6-9 (illus)
    - DA Form 7543-R, ITAS Gunnery Exercise 8: Squad Gunnery Qualification FTT, 6-8, 6-10 (illus)
- indicators, 2-1, 2-15 through 2-34
  - TAS, 2-15 (illus) through 2-34
  - adjustment, 3-19 (illus), 2-20
  - BPS, 2-35, 2-36 (illus)
  - display, 3-21 (illus)
    - crosshairs, 2-22 (illus)
    - missile types, 2-21, 2-22 (illus)
    - range, 2-21, 2-22 (illus)

- track gates, 2-23 (illus)
- FCS BIT, 2-35, (illus)
- malfunction, 2-20 (illus)
- menu, 2-23
  - BIT, 2-25, 2-26 (illus)
  - BORSGT, 2-26, 2-27 (illus)
  - main, 2-23, 2-24 (illus)
  - message, 2-33, 2-34 (illus)
  - range, 2-24, 2-25 (illus)
  - TNG, 2-27 through 2-33 (illus)
- status, 2-16 (illus)
  - MODE, 2-16, 2-17 (illus)
  - STATE, 2-17, 2-18 (illus)
- tripod, 2-1 (illus)
  - detent stop markings, 2-1 (illus)
  - level, 2-1 (illus)
- infrared, C-2 through C-18, C-22
  - through C-26
  - band, C-2 (illus)
  - characteristics, C-3
    - absorbing, C-3
    - emitting, C-3
    - reflecting, C-3
    - transmitting, C-3
  - image adjustment, C-9
    - factors that affect, C-15
      - human activity, C-18 (illus)
      - limited visibility conditions, C-15
      - range to target, C-18
      - solar heating, C-16
    - focus, C-9 through C-15
  - physical properties, C-4
    - color, C-4 (illus)
    - density, C-4
    - mass, C-5
    - surface texture, C-4, C-5 (illus)
  - sources, C-2
    - combustion, C-2 (illus)
    - friction, C-3 (illus)
    - nuclear energy, C-2
- ITAS Gunnery Exercises 5 and 6:
  - Baseline FTT Gunnery, DA Form 7541-R, 6-8 (illus)
- ITAS Gunnery Exercise 7: Squad Gunnery Practice FTT, DA Form 7542-R, 6-8, 6-9 (illus)
- ITAS Gunnery Exercise 8: Squad Gunnery Qualification FTT, DA Form 7543-R, 6-8, 6-10 (illus)
- ITAS Gunnery Exercise 9: Section Gunnery Practice FTT, DA Form 7544-R, 6-11 (illus)
- ITAS Gunnery Exercise 10: Section Gunnery Qualification FTT, DA Form 7545-R, 6-11, 6-12 (illus)
- ITAS Gunnery Exercise 11: Platoon Gunnery Practice FTT, DA Form 7546-R, 6-13 (illus)
- ITAS Gunnery Exercise 12: Platoon Gunnery Qualification FTT, DA Form 7547-R, 6-13, 6-14 (illus)
- M1121-mounted ITAS, 3-1 through 3-29
  - arm, 3-7
  - firing positions, 3-6
  - load, 3-7
  - mounting to M1121, 3-1 through 3-6 (illus)
    - hatch cover latches, 3-1, 3-2 (illus)
    - launch tube, 3-4 (illus)
    - TU adapter, 3-2, 3-3 (illus), 3-4 (illus)
  - target engagement, 3-8 through 3-12
    - acquire target, 3-9 (illus)
    - determine target, 3-9, 3-10 (illus)
    - engageability, 3-10, 3-11 (illus)
    - exposure time, 3-11 (illus)
    - launch missile, 3-11
    - manual, 3-17 (illus)
      - acquire target, 3-17 (illus)
      - determine engageability, 3-17
      - determine exposure time, 3-17, 3-18 (illus)
      - determine target type, 3-17
      - launch missile, 3-18, 3-19 (illus)
  - track gates, 3-12
    - cancel, 3-16 (illus)
    - too large, 3-13, 3-14 (illus)
    - too small, 3-13, 3-14 (illus)
    - unstable, 3-14, 3-15 (illus)
  - unload, 3-8
  - malfunctions, E-9 through E-16

- BPS, E-12, E-13
  - FCS, E-11, E-12
  - missile fault, E-15
    - hangfire procedures, E-15
    - misfire procedures, E-15
  - TAS, E-10, E-11
  - TU, E-13, E-14 (table)
- night vision sight, 1-17, 1-18 (illus)
- power source, 1-7, 1-8
  - battery, 1-7 (illus)
  - lithium-ion, 1-8 (illus)
- range card (see also *DA Form 5517-R*)
  - field-expedient, D-11 (illus)
- range determination, 4-9 through 4-12
  - binocular method, 4-9, 4-10 (illus)
    - target measurement, 4-10, 4-11 (illus)
  - daysight method, 4-9
  - night vision sight method, 4-9
- safety precautions, A-1
  - caution zone, A-1, A-2 (illus)
  - danger zone, A-1, A-2 (illus)
    - surface, A-2
  - firing angle limitations, A-3, A-4 (illus)
  - for basic skills trainer, A-6, B-2
  - for field tactical trainer, A-4, A-5, B-4
    - ATWESS danger zone, A-5 (illus)
  - missile handling, A-2
  - sighting and aiming, A-3
- Standard Range Card, *DA Form 5517-R*, (see also *DA Form 5517-R*)
- stow, 3-20 through 3-27
  - BPS, 3-22 (illus)
  - FCS, 3-26
  - launch tube, 3-21 (illus)
  - TAS, 3-23 (illus)
  - tripod, 3-26, 3-27 (illus)
  - TU on TU adapter, 3-25 (illus)
- surface danger zone, A-2
- system messages, E-1 through E-8
  - battery power source, E-2, E-3 (illus)
  - boresight, E-1
  - built-in-test (BIT), E-6
  - GRIPS test, E-7, E-8 (illus)
  - operation, E-3 through E-5
  - training, E-6
- target acquisition, C-18 through C-26
  - detailed search, C-21 (illus)
  - detection, C-20 (illus)
  - field of view, C-19
    - day, C-19
    - night vision sight, C-19
    - scanning, C-20
      - rapid, C-20, C-21 (illus)
      - slow, C-20, C-221 (illus)
  - hull defilade, C-26, C-27 (illus)
  - moving target, C-22, C-23 (illus)
  - stationary target, C-22, C-23 (illus)
    - cold, C-26
    - hot, C-24 (illus), C-25 (illus)
  - steps, C-18, C-19 (illus)
- target classification, C-27 (illus)
  - features, C-27
    - engine compartment, C-28 (illus)
    - gun tube/barrel, C-28, C-29 (illus)
    - suspension system, C-27
      - tracked (flank), C-27, C-28 (illus)
      - wheeled and tracked (frontal), C-27, C-28 (illus)
      - wheeled (flank), C-27, C-28 (illus)
  - image adjustments, C-29, C-30 (illus)
  - moving targets, C-30, C-31 (illus)
  - stationary targets, C-31
- target identification, C-33
- target recognition, C-31, C-32 (illus)
  - features, C-32 (illus), C-33 (table)
- target tracking, 4-15
  - aided target tracker, 4-15
  - deviations, 4-16
  - manual, 4-15
- TAS controls, 2-12 through 2-14
  - BPS, 2-36 through 2-42
    - ENTER switch, 2-42 (illus)
    - function switch, 2-37 through 2-41 (illus)
    - fuse, 2-42 (illus)

- INCR and DECR switch, 2-42 (illus)
- POWER switch, 2-42 (illus)
- spare fuse, 2-42 (illus)
- eyepiece assembly, 2-12, 2-13 (illus)
  - diopter adjust rings, 2-12, 2-13 (illus)
  - eyepiece cover, 2-13 (illus)
  - friction lock, 2-13 (illus)
- FCS power switch, 2-35 (illus)
- power switch, 2-13, 2-14 (illus)
  - OFF position, 2-14
  - ON position, 2-14, 2-15 (illus)
  - STANDBY position, 2-14
- TOW missile, 1-19 through 1-27
  - 2 (BGM- and BTM-71D-Series), 1-23, 1-24 (illus)
  - 2A (BGM- and BTM-71E-Series), 1-24 (illus)
  - 2B (BGM-71F and 71F-1-Series), 1-25 (illus)
  - 2B Aero (BGM-71F-3), 1-25, 1-26 (illus)
    - with GEN 1 (BGM-71F-4), 2 (BGM-71F-6), and 3A (BGM-71F-5), 1-26, 1-27 (illus)
  - basic (BGM- and BTM-71A-Series), 1-22 (illus)
  - BB (BGM-71H), 1-27, 1-28 (illus)
  - direct attack, 1-34 (illus)
  - fly-over-shoot-down, 1-35 (illus), 1-36 (illus)
  - handling, 1-28, 1-29 (illus)
  - identification, 1-20, 1-21 (table)
  - improved (ITOW, GTM- and BTM-71C-Series), 1-23 (illus)
  - inspection, 1-32 through 1-34 (illus)
    - humidity indicator, 1-32 (illus), 1-33 (illus)
    - launch container markings, 1-34 (illus)
    - overpack markings, 1-33 (illus)
  - storage, 1-29 (illus), 1-30 (table)
  - unusual conditions, 1-36, 1-37
    - air pressure, 1-36
    - cold weather, 1-36
    - high humidity, 1-36
    - high winds, 1-37
    - hot weather, 1-36
    - over water, 1-37 (see also *firing range over water*)
    - side slope, 1-37
    - smoke and fire areas, 1-37
- training, 1-1 through 1-2
  - assessment and planning, 6-3
  - devices, 6-3
    - basic skills trainer, 6-3, 6-4 (illus)
    - instructor station, 6-4
    - simulated imagery, 6-5
    - student station, 6-4
    - training exercises, 6-5
  - field tactical trainer, 6-5 (illus)
- gunnery (see *gunnery training*)
- strategy, 6-1 through 6-2
  - collective, 6-2
  - force-on-force, 6-2
  - initial, 6-1
  - leader, 6-2
  - sustainment, 6-1
- support packages and resources, 6-6
- traversing unit controls, 2-2 through 2-12 (illus)
- left handgrip, 2-2 through 2-8
  - brightness, contrast, and focus switch, 2-2 through 2-4 (illus)
  - field of view switch, 2-6, 2-7 (illus)
  - ITAS filtering system, 2-6, 2-7 (illus)
  - MENU button, 2-7 (illus)
  - release lever, 2-8 (illus)
  - sight select switch, 2-5, 2-6 (illus)
- right handgrip, 2-8 through 2-12
  - fire trigger, 2-11, 2-12 (illus)
  - FIRST/LAST switch, 2-11 (illus)
  - gate adjust switch, 2-9, 2-10 (illus)
  - laser range finder switch, 2-10, 2-11 (illus)
  - release lever, 2-11, 2-12 (illus)
  - track gate switch, 2-8, 2-9 (illus)

**This page intentionally left blank.**



**GUNNER'S SKILL TEST (ITAS)**

For use of this form, see FM 3-22.32; the proponent agency is TRADOC.

NAME:				RANK:		UNIT:		DATE:	
TASK NUMBER	TASK TITLE						GO	NO GO	
1.	ASSEMBLE AN M41 ITAS								
2.	MAINTAIN AN M41 ITAS								
3.	PERFORM PREOPERATIONAL INSPECTION ON AN M41 ITAS AND ENCASED MISSILE								
4.	PERFORM GRIPS TEST AND I-BIT FOR AN M41 ITAS								
5.	DESCRIBE AND USE OPERATOR'S CONTROLS AND INDICATORS OF THE BATTERY POWER SOURCE (BPS)								
6.	BORESIGHT AN M41 ITAS								
7.	LOAD AN M41 ITAS								
8.	UNLOAD AN M41 ITAS								
9.	DETERMINE FIRING LIMITATIONS FOR M41 ITAS								
10.	IDENTIFY COMBAT VEHICLES								
11.	DETERMINE IF A TARGET IS IN RANGE (ACTIVE/PASSIVE RANGING)								
12.	DETERMINE IF AN IN-RANGE TARGET IS ENGAGEABLE USING AN M41 ITAS								
13.	ENGAGE TARGETS WITH AN M41 ITAS								
14.	PERFORM IMMEDIATE ACTION PROCEDURES FOR M41 ITAS MALFUNCTION								
15.	MOUNT THE M41 ITAS ON THE M1121 CARRIER IN THE READY-TO-FIRE CONFIGURATION								
16.	PREPARE THE M41 ITAS IN THE DISMOUNTED READY-TO-FIRE CONFIGURATION								
17.	PREPARE AN ANTIARMOR RANGE CARD								

**This page intentionally left blank.**

**ITAS GUNNERY EXERCISE 5 AND 6: BASELINE FTT GUNNERY**

For use of this form, see FM 3-22.32; the proponent agency is TRADDC.

PRACTICE                       QUALIFICATION

SQUAD:	SECTION:	PLATOON:	COMPANY:	
DATE:		TIME:	CHECK ONE <input type="checkbox"/> DAY <input type="checkbox"/> NIGHT	
ENGAGEMENT	TARGET DISCRPTION	HIT / MISS / TIME	GO	NO GO
TARGET 1	STATIONARY TANK / FLANK / 1,000 - 1,500 METERS ± 200M	HIT MISS TIME:		
TARGET 2	STATIONARY TANK / FLANK / 2,100 - 3,750 METERS ± 200M	HIT MISS TIME:		
TARGET 3	STATIONARY TANK / FRONTAL / 2,100 - 3,750 METERS ± 200M	HIT MISS TIME:		
TARGET 4	STATIONARY TANK / DEFILADE / 2,100 - 3,750 METERS ± 200M	HIT MISS TIME:		
TARGET 5	STATIONARY TANK / FLANK / 800 - 1,500 METERS ± 200M	HIT MISS TIME:		
TARGET 6	MOVING TANK / FLANK / L-R, 30 KPH 1,600 - 2,000 METERS ± 200M / NBC	HIT MISS TIME:		
TARGET 7	MOVING TANK / FLANK / L-R, 30 KPH 1,600 - 2,000 METERS ± 200M / NBC	HIT MISS TIME:		
TARGET 8	MOVING TANK / FLANK / L-R, 5 KPH 1,000 - 1,500 METERS ± 200M	HIT MISS TIME:		
TARGET 9	MOVING TANK / FLANK / L-R, 10 KPH 2,100 - 3,750 METERS ± 200M	HIT MISS TIME:		
TARGET 10	MOVING TANK / FLANK / L-R, 40 KPH 1,600 - 2,000 METERS ± 200M	HIT MISS TIME:		
IN ORDER TO RECEIVE A GO ON ANY TARGET ENGAGEMENT, THE GUNNER MUST HIT THE TARGET WITHIN 30 SECONDS AFTER THE TARGET IS EXPOSED. TO RECEIVE A GO ON EXERCISE 5, THE CREW MUST RECEIVE A GO ON "INSTALL THE FTT" AND A GO ON AT LEAST 6 OUT OF 10 TARGET ENGAGEMENTS, BOTH DAY AND NIGHT.			OVERALL GO / NO GO:	

**This page intentionally left blank.**

**ITAS GUNNERY EXERCISE 7: SQUAD GUNNERY PRACTICE FTT**

For use of this form, see FM 3-22.32; the proponent agency is TRA00C.

TC: _____	LDR: _____	GNR: _____	OVR: _____	DATE: _____	TIME: _____	CHECK ONE <input type="checkbox"/> DAY <input type="checkbox"/> NIGHT	
PLATOON: _____			COMPANY: _____				
BATTALION: _____			BATTALION: _____				
TASK	CONDITIONS/ TARGETS/ SITUATION	TOTAL TARGET EXPOSURE TIME	HITS	ENGAGEMENT TIMES	POINTS	CREW/ LDR CUTS	TOTAL POINTS
1. ENGAGE A SINGLE TARGET	FIRE FROM BASELINE. 3,000 - 3,750 METERS ± 200M 1 STATIONARY TANK	25 SECONDS	1				
2. ENGAGE MULTIPLE TARGETS	FIRE FROM PHASE LINE 2. 2,000 - 2,500 METERS ± 200M 1-ST TANK, 1 MV TANK, 1 MV BMP	2MIN : 30SEC	1 2 3				
3. ENGAGE MULTIPLE TARGETS	FIRE FROM PHASE LINE 3. 2,500 - 3,000 METERS ± 200 M 1-MV TANK, 1-ST BMP	1MIN : 40SEC	1 2				
4. ENGAGE MULTIPLE TARGETS	FIRE FROM PHASE LINE 2. 2,500 - 3,000 METERS ± 200 M 1-ST TANK, 1-MV TANK (NBC)	1MIN : 40SEC	1 2				
5. ENGAGE MULTIPLE TARGETS	FIRE FROM BASELINE. 2,500 - 3,000 METERS ± 200 M 1-MV TANK, 1-MV BMP (NBC)	1MIN : 40SEC	1 2				
NOTES:						TOTAL SCORE: _____	
<p>1. ENGAGEMENT TIMES ARE CALCULATED FROM THE TIME THE TARGET IS EXPOSED TO THE TIME THE TARGET IS HIT. USE THE LIVE FIRE POINT CALCULATION SHEET FOR SECOND AND THIRD ENGAGEMENTS FROM THE SAME POSITION. THE TIME IS STARTED WHEN THE VEHICLE REOCCUPIES ITS FIRING POSITION (STDPS MOVING) AND ENDS WHEN THE TARGET IS HIT.</p> <p>2. EACH TASK IS WORTH 100 POINTS. EACH TARGET IS ALSO WORTH 100 POINTS FOR TASKS WITH MULTIPLE ENGAGEMENTS. TOTAL THE NUMBER OF POINTS AND DIVIDE BY THE NUMBER OF TARGETS PRESENTED.</p> <p>3. CREW CUTS- SEE FM 3-22.32, CHAPTER 6.</p> <p>4. SCORING EXERCISE 7 IS PERFORMED TWICE, ONCE DURING THE DAY AND ONCE AT NIGHT. EACH EVENT IS WORTH A MAXIMUM OF 500 POINTS.</p>							

**This page intentionally left blank.**

**ITAS GUNNERY EXERCISE 8: SQUAD GUNNERY QUALIFICATION FTT**

For use of this form, see FM 3-22.32; the proponent agency is TRADOC.

TC:	LDR:	GNR:	DVR:	DATE:	TIME:	CHECK ONE <input type="checkbox"/> DAY <input type="checkbox"/> NIGHT
PLATOON:			COMPANY:			
BATTALION:			BATTALION:			

TASK	CONDITIONS/TARGETS/SITUATION	TOTAL TARGET EXPOSURE TIME	HITS	ENGAGEMENT TIMES	POINTS	CREW/LDR DUTS	TOTAL POINTS
1. ENGAGE A SINGLE TARGET	FIRE FROM BASELINE. 1,500 - 2,000 METERS ± 200M 1 STATIONARY TANK	25 SECONDS	1				
2. ENGAGE MULTIPLE TARGETS	FIRE FROM PHASE LINE 1. 2,000 - 2,500 METERS ± 200M 1 MV TANK, 1 ST BMP	1MIN - 40SEC	1 2				
3. ENGAGE MULTIPLE TARGETS	FIRE FROM PHASE LINE 2. 3,000 - 3,750 METERS ± 200 M 2-MV TANK, 1-ST BMP	2MIN - 45SEC	1 2 3				
4. ENGAGE MULTIPLE TARGETS	FIRE FROM PHASE LINE 1. 1,500 - 2,000 METERS ± 200 M 1-ST TANK, 1-MV BMP (NBC)	1MIN - 40SEC	1 2				
5. ENGAGE MULTIPLE TARGETS	FIRE FROM BASELINE. 2,500 - 3,000 METERS ± 200 M 1-MV TANK, 1-MV BMP (NBC)	1MIN - 40SEC	1 2				

TOTAL SCORE: \_\_\_\_\_

**NOTES:**

1. ENGAGEMENT TIMES ARE CALCULATED FROM THE TIME THE TARGET IS EXPOSED TO THE TIME THE TARGET IS HIT. USE THE LIVE FIRE POINT CALCULATION SHEET FOR SECOND AND THIRD ENGAGEMENTS FROM THE SAME POSITION. THE TIME IS STARTED WHEN THE VEHICLE OCCUPIES ITS FIRING POSITION (STOP'S MOVING) AND ENDS WHEN THE TARGET IS HIT.
2. EXERCISE 8, UNLIKE EXERCISE 7, IS FOR QUALIFICATION. THE SQUAD IS RATED ON ITS FINAL SCORE, RATHER THAN SIMPLY HAVING TO MEET A MINIMUM STANDARD.
3. SCORING EXERCISE 8: EXERCISE 8 IS PERFORMED TWICE, ONCE DURING THE DAY AND ONCE AT NIGHT. EACH EVENT IS WORTH A MAXIMUM OF 500 POINTS.

<input type="checkbox"/> <b>DISTINGUISHED:</b> 900 - 1,000 POINTS	<input type="checkbox"/> <b>SUPERIOR:</b> 800 - 899 POINTS	<input type="checkbox"/> <b>QUALIFIED:</b> 700 - 799 POINTS
<input type="checkbox"/> <b>UNQUALIFIED:</b> 0 - 699 POINTS		

**This page intentionally left blank.**



**ITAS GUNNERY EXERCISE 9: SECTION GUNNERY PRACTICE FTT**

For use of this form, see FM 3-22.32; the proponent agency is TRADOC.

SECTION	TC: _____	LDR: _____	GNR: _____	DVR: _____	DATE: _____	TIME: _____	CHECK ONE
SQUAD	TC: _____	LDR: _____	GNR: _____	DVR: _____			<input type="checkbox"/> DAY <input type="checkbox"/> NIGHT
PLATOON:	COMPANY: _____			BATTALION: _____			

TASK	CONDITIONS/ TARGETS/ SITUATION	TOTAL TARGET EXPOSURE TIME	HITS	ENGAGEMENT TIMES	POINTS	CREW/ LDR CUTS	TOTAL POINTS
1. ENGAGE MULTIPLE TARGETS	FIRE FROM BASELINE. 3,000 - 3,750 METERS ± 200M 1-ST TANK, 1-ST BMP	40 SECONDS	1 .2				
2. ENGAGE A SINGLE TARGET	FIRE FROM PHASE LINE 2. 2,000 - 2,750 METERS ± 200M 1-ST BMP	1MIN - 40SEC	1				
3. ENGAGE MULTIPLE TARGETS	FIRE FROM PHASE LINE 3. 1,000 - 1,500 METERS ± 200 M 2-MV BMP, 1-ST TANK	2MIN - 45SEC	1 2 3				
4. ENGAGE MULTIPLE TARGETS	FIRE FROM PHASE LINE 1. 2,500 - 3,000 METERS ± 200 M 2-MV TANKS, 2-ST TANKS (NBC)	2MIN - 38SEC	1 2 3 4				
5. ENGAGE MULTIPLE TARGETS	FIRE FROM BASELINE. 1,000 - 1,500 METERS ± 200 M 1-ST TANK, 1-ST BMP (NBC)	25 SECONDS	1 2				

NOTES: \_\_\_\_\_

TOTAL SCORE: \_\_\_\_\_

- ENGAGEMENT TIMES ARE CALCULATED FROM THE TIME THE TARGET IS EXPOSED TO THE TIME THE TARGET IS HIT. USE THE LIVE FIRE POINT CALCULATION SHEET FOR SECOND AND THIRD ENGAGEMENTS FROM THE SAME POSITION. THE TIME IS STARTED WHEN THE VEHICLE REOCCUPIES ITS FIRING POSITION (STOPS MOVING) AND ENDS WHEN THE TARGET IS HIT.
- SCORING EXERCISE 9: EXERCISE 9 IS PERFORMED TWICE, ONCE DURING THE DAY AND ONCE AT NIGHT. EACH EVENT IS WORTH A MAXIMUM OF 500 POINTS FOR A POSSIBLE TOTAL OF 1,000 POINTS. EXERCISE 9 IS A PRACTICE EXERCISE. IN ORDER TO VERIFY ON EXERCISE 9 AND PROCEED TO EXERCISE 10, THE SECTION MUST ACHIEVE A MINIMUM COMBINED SCORE OF AT LEAST 700 POINTS, AFTER CREW AND LEADER CUTS.

**This page intentionally left blank.**

**ITAS GUNNERY EXERCISE 10: SECTION GUNNERY QUALIFICATION FTT**

For use of this form, see FM 3-22.32; the proponent agency is TRAOC.

SECTION	TC: _____	LDR: _____	GNR: _____	DVR: _____	DATE: _____	TIME: _____	CHECK ONE
SQUAD	TC: _____	LDR: _____	GNR: _____	DVR: _____			<input type="checkbox"/> DAY <input type="checkbox"/> NIGHT
PLATOON:	COMPANY: _____			BATTALION: _____			

TASK	CONDITIONS/ TARGETS/ SITUATION	TOTAL TARGET EXPOSURE TIME	HITS	ENGAGEMENT TIMES	POINTS	CREW/ LDR CUTS	TOTAL POINTS
1. ENGAGE MULTIPLE TARGETS	FIRE FROM BASELINE. 3,000 - 3,750 METERS ± 200M 2 MV TANK, 2 ST BMP	25 SECONDS	1 2 3 4				
2. ENGAGE A SINGLE TARGET	FIRE FROM PHASE LINE 2. 2,000 - 2,500 METERS ± 200M 1 MV TANK	40 SECONDS	1				
3. ENGAGE MULTIPLE TARGETS	FIRE FROM PHASE LINE 3. 1,000 - 1,500 METERS ± 200 M 1-MV BMP, 1-ST TANK	25 SECONDS	1 2				
4. ENGAGE MULTIPLE TARGETS	FIRE FROM PHASE LINE 2. 2,500 - 3,000 METERS ± 200 M 1-ST BMP, 2-MV TANKS (NBC)	2MIN - 40SEC	1 2 3				
5. ENGAGE MULTIPLE TARGETS	FIRE FROM BASELINE. 3,000 - 3,750 METERS ± 200 M 1-ST TANK, 1-ST BMP (NBC)	25 SECONDS	1 2				
TOTAL SCORE: _____							

**NOTES:**

- ENGAGEMENT TIMES ARE CALCULATED FROM THE TIME THE TARGET IS EXPOSED TO THE TIME THE TARGET IS HIT. USE THE LIVE FIRE POINT CALCULATION SHEET FOR SECOND AND THIRD ENGAGEMENTS FROM THE SAME POSITION. THE TIME IS STARTED WHEN THE VEHICLE OCCUPIES ITS FIRING POSITION (STOPS MOVING) AND ENDS WHEN THE TARGET IS HIT.
- EXERCISE 10, UNLIKE EXERCISE 9, IS FOR QUALIFICATION. THE SQUAD IS RATED ON ITS FINAL SCORE, RATHER THAN SIMPLY HAVING TO MEET A MINIMUM STANDARD.
- SCORING EXERCISE 10 IS PERFORMED TWICE, ONCE DURING THE DAY AND ONCE AT NIGHT. EACH EVENT IS WORTH A MAXIMUM OF 500 POINTS FOR A POSSIBLE TOTAL OF 1,000 POINTS. EXERCISE 10 IS A QUALIFICATION EXERCISE. IN ORDER TO PROGRESS TO EXERCISE 11, THE SECTION MUST ACHIEVE A MINIMUM COMBINED SCORE OF AT LEAST 700 POINTS.

<input type="checkbox"/> <b>DISTINGUISHED:</b> 900 - 1,000 POINTS	<input type="checkbox"/> <b>SUPERIOR:</b> 800 - 899 POINTS	<input type="checkbox"/> <b>QUALIFIED:</b> 700 - 799 POINTS
<input type="checkbox"/> <b>UNQUALIFIED:</b> 0 - 699 POINTS		

**This page intentionally left blank.**

**ITAS GUNNERY EXERCISE 11: PLATOON GUNNERY PRACTICE FTT**

For use of this form, see FM 3-22.32; the proponent agency is TRADOC.

<b>SECTION 1:</b>	TOW CREW 1:	TC: _____	LDR: _____	GNR: _____	DVR: _____	DATE: _____
	TOW CREW 2:	TC: _____	LDR: _____	GNR: _____	DVR: _____	
<b>SECTION 2:</b>	TOW CREW 1:	TC: _____	LDR: _____	GNR: _____	DVR: _____	TIME: _____
	TOW CREW 2:	TC: _____	LDR: _____	GNR: _____	DVR: _____	
<b>SECTION 3:</b>	TOW CREW 1:	TC: _____	LDR: _____	GNR: _____	DVR: _____	CHECK ONE
	TOW CREW 2:	TC: _____	LDR: _____	GNR: _____	DVR: _____	<input type="checkbox"/> DAY <input type="checkbox"/> NIGHT

PLATOON: \_\_\_\_\_ COMPANY: \_\_\_\_\_ BATTALION: \_\_\_\_\_

TASK	CONDITIONS/ TARGETS/ SITUATION	TOTAL TARGET EXPOSURE TIME	HITS	ENGAGEMENT TIMES	POINTS	CREW/ LDR CUTS	TOTAL POINTS
1. ENGAGE MULTIPLE TARGETS	FIRE FROM BASELINE. 3,000 - 3,750 METERS ± 200M 4 MV TANK, 2 ST BMP	3MIN - 26SEC	1 2 3 4 5 6				
2. ENGAGE MULTIPLE TARGETS	FIRE FROM PHASE LINE 2. 2,000 - 3,000 METERS ± 200M 4 MV BMPS, 2 ST BMPS	2MIN - 26SEC	1 2 3 4 5 6				
3. ENGAGE MULTIPLE TARGETS	FIRE FROM PHASE LINE 3. 1,000 - 2,000 METERS ± 200 M 2-ST TANKS, 2-ST BMPS	25 SECONDS	1 2 3 4				
4. ENGAGE MULTIPLE TARGETS	FIRE FROM PHASE LINE 2. 2,000 - 3,000 METERS ± 200 M 2-MV TANKS, 2-MV BMP (MBC)	43 SECONDS	1 2 3 4				
5. ENGAGE MULTIPLE TARGETS	FIRE FROM BASELINE. 3,000 - 3,750 METERS ± 200 M 2-ST TANK, 2-ST BMP (MBC)	25 SECONDS	1 2 3 4				
<b>TOTAL SCORE:</b> _____							

NOTES:  
EXERCISE 11 IS CONDUCTED, TIMED, AND SCORED IN EXACTLY THE SAME MANNER AS THE PREVIOUS EXERCISES 7 THRU 10.

<input type="checkbox"/> DISTINGUISHED: 900 - 1,000 POINTS	<input type="checkbox"/> SUPERIOR: 800 - 899 POINTS	<input type="checkbox"/> QUALIFIED: 700 - 799 POINTS	<input type="checkbox"/> UNQUALIFIED: 0 - 699 POINTS
---	--	---	---

**This page intentionally left blank.**

**ITAS GUNNERY EXERCISE 12: PLATOON GUNNERY QUALIFICATION FFT**

For use of this form, see FM 3-22.32; the proponent agency is TRADOC.

<b>SECTION 1:</b>	TOW CREW 1:	TC: _____	LDR: _____	GNR: _____	DVR: _____	DATE: _____
	TOW CREW 2:	TC: _____	LDR: _____	GNR: _____	DVR: _____	
<b>SECTION 2:</b>	TOW CREW 1:	TC: _____	LDR: _____	GNR: _____	DVR: _____	TIME: _____
	TOW CREW 2:	TC: _____	LDR: _____	GNR: _____	DVR: _____	
<b>SECTION 3:</b>	TOW CREW 1:	TC: _____	LDR: _____	GNR: _____	DVR: _____	CHECK ONE
	TOW CREW 2:	TC: _____	LDR: _____	GNR: _____	DVR: _____	<input type="checkbox"/> DAY <input type="checkbox"/> NIGHT

PLATOON: \_\_\_\_\_ COMPANY: \_\_\_\_\_ BATTALION: \_\_\_\_\_

TASK	CONDITIONS/ TARGETS/ SITUATION	TOTAL TARGET EXPOSURE TIME	HITS	ENGAGEMENT TIMES	POINTS	CREW/ LDR CUTS	TOTAL POINTS
1. ENGAGE MULTIPLE TARGETS	FIRE FROM BASELINE. 3,000 - 3,750 METERS ± 200M 2-MV TANK, 2-ST BMP	25 SECONDS	1 2 3 4				
2. ENGAGE MULTIPLE TARGETS	FIRE FROM PHASE LINE 2. 2,000 - 3,000 METERS ± 200M 3-ST BMPS, 3-MV TANKS	2MIN : 28SEC	1 2 3 4 5 6				
3. ENGAGE MULTIPLE TARGETS	FIRE FROM PHASE LINE 3. 1,000 - 2,000 METERS ± 200 M 3-ST TANKS, 3-MV BMPS	1MIN : 8SEC	1 2 3 4 5 6				
4. ENGAGE MULTIPLE TARGETS	FIRE FROM PHASE LINE 2. 2,000 - 3,000 METERS ± 200 M 2-MV TANKS, 2-MV BMP (NBC)	34 SECONDS	1 2 3 4				
5. ENGAGE MULTIPLE TARGETS	FIRE FROM BASELINE. 3,000 - 3,750 METERS ± 200 M 2-ST TANK, 2-ST BMP (NBC)	25 SECONDS	1 2 3 4				

NOTES: \_\_\_\_\_

EXERCISE 12 IS CONDUCTED, TIMED, AND SCORED IN EXACTLY THE SAME MANNER AS THE PREVIOUS EXERCISES 7 THRU 11.

<input type="checkbox"/> DISTINGUISHED: 800 - 1,000 POINTS	<input type="checkbox"/> SUPERIOR: 800 - 899 POINTS	<input type="checkbox"/> QUALIFIED: 700 - 799 POINTS	<input type="checkbox"/> UNQUALIFIED: 0 - 699 POINTS
---	--	---	---

**This page intentionally left blank.**



By Order of the Secretary of the Army:

**PETER J. SCHOOMAKER**  
*General, United States Army*  
*Chief of Staff*

Official:



**SANDRA R. RILEY**  
*Administrative Assistant to the*  
*Secretary of the Army*  
0516801

**DISTRIBUTION:**

*Active Army, Army National Guard, and U.S. Army Reserve:* To be distributed in accordance with initial distribution number 113885, requirements for FM 3-22.32.

**This page intentionally left blank.**



